



**INSTRUMENTS**

# **GX-6000**

## **Operator's Manual**

*Part Number: 71-0362*

*Revision: J*

*Released: 11/19/18*

# **WARNING**

Read and understand this instruction manual before operating instrument. Improper use of the gas monitor could result in bodily harm or death.

Periodic calibration and maintenance of the gas monitor is essential for proper operation and correct readings. Please calibrate and maintain this instrument regularly! Frequency of calibration depends upon the type of use you have and the sensor types. Typical calibration frequencies for most applications are between 1 and 3 months, but can be required more often or less often based on your usage.

---

# Table of Contents

<b>Chapter 1: Introduction</b> .....	<b>9</b>
Overview .....	9
About the GX-6000 .....	9
Specifications .....	11
About this Manual .....	14
<b>Chapter 2: Description</b> .....	<b>15</b>
Overview .....	15
Instrument Description .....	15
<i>Case</i> .....	15
<i>LCD</i> .....	15
<i>Control Buttons</i> .....	16
<i>Flashlight LED</i> .....	16
<i>Alarm LEDs</i> .....	16
<i>Infrared Communications Port</i> .....	16
<i>Buzzer</i> .....	17
<i>Vibrator</i> .....	17
<i>Printed Circuit Boards (PCBs)</i> .....	17
<i>Pump</i> .....	17
<i>Flow Chamber</i> .....	17
<i>Sensors</i> .....	17
<i>Filters</i> .....	18
<i>Inlet Filter Holder</i> .....	19
<i>Batteries</i> .....	19
Included Accessories .....	20
<i>Tapered Rubber Nozzle</i> .....	20
<i>Belt Clip</i> .....	20
<i>Rubber Boot</i> .....	20
<i>Wrist Strap</i> .....	20
<i>Sample Hose and Probe</i> .....	20
<i>Screen Protector</i> .....	21
Other Accessories .....	21
<i>VOC Zero Filter</i> .....	21
<i>External Dilution Fitting</i> .....	22
<i>DIN Rail Mounting Assembly</i> .....	22
<b>Chapter 3: Operation</b> .....	<b>25</b>
Overview .....	25
Start Up .....	25
<i>Turning On the GX-6000</i> .....	25
<i>Performing a Demand Zero</i> .....	34
<i>Turning Off the GX-6000</i> .....	34

Measuring Mode, Normal Operation . . . . .	35
<i>Monitoring an Area</i> . . . . .	35
<i>Using Optional Sample Hoses</i> . . . . .	36
<i>Combustible Gas Detection</i> . . . . .	36
<i>VOC Detection</i> . . . . .	38
<i>Oxygen Detection</i> . . . . .	38
<i>Snap Log Mode</i> . . . . .	39
Measuring Mode, Alarms . . . . .	41
<i>Alarm Indications</i> . . . . .	41
<i>Responding to Alarms</i> . . . . .	43
Display Mode . . . . .	47
<i>Tips for Using Display Mode</i> . . . . .	48
<i>PID Gas Name Screen</i> . . . . .	49
<i>Peak Screen</i> . . . . .	51
<i>STEL Screen</i> . . . . .	52
<i>TWA Screen</i> . . . . .	52
<i>View Alarm Settings Screen</i> . . . . .	53
<i>Time in Operation Screen</i> . . . . .	55
<i>Date/Time, Battery Voltage Screen</i> . . . . .	55
<i>Log Time Remaining Screen</i> . . . . .	56
<i>Clear Data Logging Screen</i> . . . . .	56
<i>Pump Off Screen</i> . . . . .	58
<i>Select User ID Screen</i> . . . . .	59
<i>Select Station ID Screen</i> . . . . .	60
<i>Viewing Snap Logger Data</i> . . . . .	62
<i>Peak Bar Screen</i> . . . . .	63
<i>Gas Display Screen</i> . . . . .	64
<i>LCD Flip Screen</i> . . . . .	65
<i>Combustible Sensor Protection Screen</i> . . . . .	66
<i>LCD Background Color Flip Screen</i> . . . . .	67
<i>Language Screen</i> . . . . .	67
Data Logging . . . . .	68
<b>Chapter 4: Calibration Mode . . . . .</b>	<b>70</b>
Overview . . . . .	70
Calibration Supplies and Equipment . . . . .	71
Entering Calibration Mode . . . . .	71
Calibrating Using the Auto Calibration Method . . . . .	72
<i>Setting the Fresh Air Reading</i> . . . . .	72
<i>Performing a Span Adjustment</i> . . . . .	75
<i>Returning to Measuring Mode</i> . . . . .	82
Calibrating Using the Single Calibration Method . . . . .	83
<i>Setting the Fresh Air Reading</i> . . . . .	83
<i>Performing a Span Adjustment in Single Calibration</i> . . . . .	84
Performing a Bump Test . . . . .	88

<b>Chapter 5: User Mode</b> .....	<b>93</b>
Overview .....	93
Tips for Using User Mode .....	93
Entering User Mode .....	93
Setting the Date and Time .....	95
Setting the Date Format .....	95
Configuring the Channels .....	95
Updating the Language Setting .....	97
Viewing the ROM/SUM of the Instrument .....	98
Turning the Password Function On or Off .....	98
Exiting User Mode .....	99
<b>Chapter 6: Maintenance</b> .....	<b>100</b>
Overview .....	100
Troubleshooting .....	100
Replacing or Recharging the Batteries .....	102
<i>Replacing the Alkaline Batteries</i> .....	102
<i>Replacing the Lithium Ion Battery Pack</i> .....	104
<i>Recharging the Lithium Ion Battery Pack</i> .....	105
<i>Recharging the Lithium Ion Battery Pack Out of the Instrument</i> .....	108
Replacing the Probe's Particle Filter and Hydrophobic Filter Disk .....	112
Replacing the H <sub>2</sub> S Scrubber Disk and the Charcoal Filter .....	113
Replacing a Sensor .....	116
Replacing the Hydrophobic Filter and Wire Mesh Disk .....	119
PID Sensor Maintenance .....	120
<i>Cleaning the PID Sensor's Lamp</i> .....	120
<i>Replacing the PID Sensor's Lamp</i> .....	124
<i>Replacing the PID Sensor's Electrode Stack</i> .....	128
General Parts List .....	131
<b>Appendix A: Maintenance Mode</b> .....	<b>134</b>
Overview .....	134
Tips for Using Maintenance Mode .....	138
Using Maintenance Mode .....	138
<i>Setting the Date and Time</i> .....	141
<i>Setting the Date Format</i> .....	141
<i>Performing a Calibration</i> .....	141
<i>Performing a Bump Test</i> .....	142
<i>Updating Calibration Settings</i> .....	142
<i>Updating Bump Test Settings</i> .....	144
<i>Updating Alarm Parameters</i> .....	148
<i>Turning the Pump On/Off Display On or Off</i> .....	151
<i>Turning the User/Station ID Function On or Off</i> .....	151
<i>Updating the Backlight Time Setting</i> .....	151
<i>Updating the Language Setting</i> .....	152
<i>Updating the Lunch Break Setting</i> .....	152
<i>Updating the Auto Zero Setting</i> .....	152

<i>Updating the Demand Zero Setting</i> .....	153
<i>Zero Follower Setting</i> .....	153
<i>Zero Suppression Settings</i> .....	153
<i>Updating the Autoranging Setting</i> .....	153
<i>Updating the Confirmation Alert Setting</i> .....	153
<i>Turning the Key Tone Noise On or Off</i> .....	154
<i>Turning Inert Mode On or Off</i> .....	154
<i>Updating the Leak Check/Bar Hole Mode Setting</i> .....	154
<i>Setting the Bar Hole Measurement Time</i> .....	155
<i>Updating the CO Display Setting</i> .....	155
<i>Updating the Man Down Settings</i> .....	156
<i>Updating the Datalogging Parameters</i> .....	158
<i>Adjusting the Low Flow Setpoint</i> .....	159
<i>Viewing the ROM/SUM of the Instrument</i> .....	160
<i>Turning the Password Function On or Off</i> .....	160
<i>Restoring the Default Settings</i> .....	161
<i>Exiting Maintenance Mode</i> .....	162

## **Appendix B: Maintenance Mode 2 ..... 163**

Overview .....	163
Tips for Using Maintenance Mode 2 .....	163
Using Maintenance Mode 2 .....	164
<i>Changing the Gas Combination</i> .....	166
<i>Changing the Catalytic LEL Channel's Target Gas</i> .....	167
<i>Exiting Maintenance Mode 2</i> .....	167

## **Appendix C: ESS-03 Toxic Sensors ..... 168**

Overview .....	168
Description .....	168
Interference .....	169
Start Up and Normal Operation .....	170
ESS-03 Calibration .....	170
<i>Calibrating the ESS-03 Sensor Using Auto Calibration</i> .....	170
<i>Calibrating the ESS-03 Sensor Using Single Calibration</i> .....	176
ESS-03 Bump Testing .....	176
Replacing the ESS-03 Sensor or Changing Sensor Type .....	176
Parts List .....	178

## **Appendix D: IR Sensors ..... 179**

Overview .....	179
<i>IR HC Target Gases</i> .....	179
<i>IR CH4 Target Gases</i> .....	179
Description .....	180
<i>IR Sensor</i> .....	180
<i>CO2 Scrubber</i> .....	181
IR HC Start Up and Normal Operation .....	185
<i>0 - 100 %LEL/2.0 - 30.0 %vol Autoranging</i> .....	182

IR CH4 Start Up and Normal Operation . . . . .	182
<i>0 - 100 %LEL/5.0 - 100.0 %vol Autoranging</i> . . . . .	182
IR CO2 Start Up and Normal Operation . . . . .	183
<i>Performing a Demand Zero for Carbon Dioxide Sensors</i> . . . . .	183
IR Calibration . . . . .	185
IR Bump Testing . . . . .	185
Replacing an IR Sensor . . . . .	185
Parts List . . . . .	187
<b>Appendix E: Using the GX-6000 in Leak Check Mode . . . . .</b>	<b>188</b>
Overview . . . . .	188
Start Up, Leak Check Mode . . . . .	188
<i>Turning On the GX-6000, Leak Check Mode</i> . . . . .	188
<i>Performing a Demand Zero, Leak Check Mode</i> . . . . .	190
Leak Testing . . . . .	190
<i>Setting the Display Range Value</i> . . . . .	191
<i>Turning the Alarm On and Off</i> . . . . .	191
<i>Locating a Leak</i> . . . . .	191
<i>Overscale Conditions</i> . . . . .	192
<i>Peak Hold Mode</i> . . . . .	192
<i>Snap Log Mode, Leak Check Mode Operation</i> . . . . .	193
<i>Viewing Snap Log Data in Leak Check Mode</i> . . . . .	195
<i>Turning Off the GX-6000, Leak Check Mode</i> . . . . .	197
<b>Appendix F: Using the GX-6000 in Bar Hole Mode . . . . .</b>	<b>198</b>
Overview . . . . .	198
Start Up, Bar Hole Mode . . . . .	199
<i>Turning on the GX-6000, Bar Hole Mode</i> . . . . .	199
<i>Performing a Fresh Air Adjustment, Bar Hole Mode</i> . . . . .	200
Bar Hole Testing . . . . .	201
<i>Performing a Bar Hole Test</i> . . . . .	201
<i>Turning Off the GX-6000, Bar Hole Mode</i> . . . . .	204
<b>Appendix G: Using the GX-6000 in Inert Mode . . . . .</b>	<b>205</b>
Alarms . . . . .	205
Start Up and Operation . . . . .	206
<b>Appendix H: 10.0 eV/Benzene PID Sensor . . . . .</b>	<b>207</b>
Overview . . . . .	207
Sensor Description . . . . .	207
Tube and Tube Holder . . . . .	208
<i>Tube</i> . . . . .	
<i>Tube Holder</i> . . . . .	208
Start Up . . . . .	209
Display Mode . . . . .	209
Measuring Mode . . . . .	210
Benzene Select Mode . . . . .	211

Viewing Benzene Select Mode Data. . . . .	217
Calibrating the 10.0 eV/Benzene PID Sensor. . . . .	219
<i>Important Calibration Information.</i> . . . .	219
<i>Performing an AUTO CAL.</i> . . . .	220
<i>Performing a SINGLE CAL.</i> . . . .	220
<i>Performing a TUBE CAL.</i> . . . .	221
<i>Entering a CAL CODE.</i> . . . .	228
Maintenance . . . . .	229
<i>Replacing a Sensor.</i> . . . .	229
<i>PID Sensor Maintenance.</i> . . . .	229
<i>Replacing a Tube.</i> . . . .	229
Parts List . . . . .	231

**Appendix I: 11.7 eV PID Sensor . . . . . 232**

Overview. . . . .	232
11.7 eV PID Lamp Warranty. . . . .	232
Description . . . . .	233
<i>Instrument.</i> . . . .	233
<i>Sensor.</i> . . . .	233
<i>Dehumidifier Filter.</i> . . . .	233
Start Up. . . . .	234
Display Mode . . . . .	234
Measuring Mode. . . . .	235
<i>Turning off a GX-6000 with an 11.7 eV Sensor.</i> . . . .	235
Calibrating the 11.7 eV PID Sensor . . . . .	236
<i>Setting the Fresh Air Reading.</i> . . . .	236
<i>Performing an AUTO CAL.</i> . . . .	236
<i>Performing a SINGLE CAL.</i> . . . .	237
Maintenance . . . . .	237
<i>Replacing the Dehumidifier Filter.</i> . . . .	237
<i>Replacing a Sensor.</i> . . . .	237
<i>PID Sensor Maintenance.</i> . . . .	237
Parts List for 11.7 eV PID Instruments. . . . .	238

**WARNING:**    *Understand manual before operating. Substitution of components may impair intrinsic safety. To prevent ignition of a hazardous atmosphere, batteries must only be changed or charged in an area known to be nonhazardous. Not tested in oxygen enriched atmospheres (above 21%).*

---

**NOTE:**    RKI Instruments, Inc. recommends that you refer to ISA-RP12.13, Part II-1987 or an equivalent international recommended practice for guidance in the use of combustible gas detection instruments.

---



# Chapter 1: Introduction

---

## Overview

This chapter briefly describes the GX-6000 gas monitor. This chapter also describes the *GX-6000 Operator's Manual* (this document). Table 1 at the end of this chapter lists the specifications for the GX-6000.

---

## About the GX-6000

Using an advanced detection system consisting of up to six gas sensors, the GX-6000 sample draw gas monitor is capable of detecting the presence of combustible gas, oxygen (O<sub>2</sub>), carbon monoxide (CO), hydrogen sulfide (H<sub>2</sub>S), and various other toxic gases simultaneously. The GX-6000's rugged, reliable, and easy-to-use design makes it ideally suited for a wide range of applications, including sewage treatment plants, utility manholes, tunnels, hazardous waste sites, power stations, petrochemical refineries, mines, paper mills, drilling rigs, and fire fighting stations. The GX-6000 offers a full range of features including:

- Simultaneous monitoring of one to six gases.
- Choice of three operating modes:
  - Normal Mode for typical confined space or area monitoring. Normal Mode is the standard factory setting.
  - Bar Hole Mode for checking of bar holes when searching for underground gas leaks
  - Leak Check Mode for locating leaks in valves and piping
- Sample-drawing pump with up to 50 foot range
- Liquid crystal display (LCD) for complete and understandable information at a glance
- Ultrabright alarm LEDs
- Distinctive audible/vibrating alarms for dangerous gas conditions and audible alarms for unit malfunction
- Microprocessor control for reliability, ease of use, and advanced capabilities
- Data logging functions (when used in Normal Mode)
- Alarm trend data (when used in Normal Mode)
- STEL and TWA (when used in Normal Mode) and over range alarms
- Peak readings (when used in Normal Mode)
- Built-in time function
- Lunch break feature
- RF shielded high impact plastic case
- CSA "C/US" classification for Class I, Division I, Groups A, B, C, and D hazardous atmospheres

**WARNING:** *The Model GX-6000 detects oxygen deficiency, elevated levels of oxygen, combustible gases, carbon monoxide, and hydrogen sulfide, all of which can be dangerous or life threatening. When using the GX-6000, you must follow the instructions and warnings in this manual to assure proper and safe operation of the unit and to minimize the risk of personal injury. Be sure to maintain and periodically calibrate the GX-6000 as described in this manual.*

---

**NOTE:** ONLY THE COMBUSTIBLE GAS DETECTION PORTION OF THIS INSTRUMENT HAS BEEN ASSESSED FOR PERFORMANCE.

---

# Specifications

**Table 1: Standard Sensor Specifications/Alarm Points**


	Combustible Gas, Methane (CH <sub>4</sub> ) Calibration Standard**	Oxygen (O <sub>2</sub> )	Hydrogen Sulfide (H <sub>2</sub> S)	Carbon Monoxide (CO)	VOCs, Isobutylene Calibration Standard**	
					Low Range PID	High Range PID
Detection Range	0 - 100 %LEL	0 - 40 volume%	0 - 100.0 ppm	0 - 500 ppm	0 - 50000 ppb	0 - 6000 ppm
Reading Increment	1 %LEL	0.1 volume%	0.5 ppm	1 ppm	<ul style="list-style-type: none"> <li>• 0 - 5000: 1 ppb</li> <li>• 5000 - 50000: 10 ppb</li> </ul>	<ul style="list-style-type: none"> <li>• 0 - 600 ppm: 0.1 ppm</li> <li>• 600 - 6000 ppm: 1 ppm</li> </ul>
Alarm 1 Factory Setting	10 %LEL*	19.5 volume%, decreasing*	5.0 ppm*	25 ppm*	5000 ppb*	400 ppm*
Alarm 2 Factory Setting	50 %LEL	23.5 volume%, increasing	30.0 ppm	50 ppm	10000 ppb	1000 ppm
STEL Alarm	n/a	n/a	5.0 ppm	200 ppm	n/a	60.0 ppm
TWA Alarm	n/a	n/a	1.0 ppm	25 ppm	n/a	40.0 ppm

\* When calibrating the GX-6000 with the Auto Calibration or the Single Calibration method, the calibration gas value must be equal to or higher than the alarm 1 setting. See "Updating the Alarm Point Settings" on page 149 for instructions to change the alarm points if necessary for the desired calibration gas value.

\*\* Although calibrated to a specific gas, these sensors will respond to a variety of gases.

**Table 2: GX-6000 Specifications**

Sampling Method	Sample Draw
Response Time	T90 Within 30 Seconds
Display	Graphics LCD Display
Operating Temperature & Humidity	-20°C to 50°C/Below 95% RH (Without Condensation)

<p>Indication Accuracy</p>	<p><b>Combustible Gas (LEL), Catalytic Type Sensor</b></p> <ul style="list-style-type: none"> <li>-10°C to 40°C: 5% of full scale</li> <li>-20°C to 50°C: 6% of full scale</li> </ul> <p><b>Oxygen</b></p> <ul style="list-style-type: none"> <li>± 0.5% O<sub>2</sub></li> </ul> <p><b>Hydrogen Sulfide</b></p> <ul style="list-style-type: none"> <li>± 5% of reading or ± 2 ppm H<sub>2</sub>S (whichever is greater)</li> </ul> <p><b>Carbon Monoxide</b></p> <ul style="list-style-type: none"> <li>± 5% of reading or ± 5 ppm CO (whichever is greater)</li> </ul> <p><b>PID</b></p> <ul style="list-style-type: none"> <li>± 10% of reading or ± 1 increment (whichever is greater)</li> </ul>
<p>Safety/Regulatory</p>	<ul style="list-style-type: none"> <li>ATEX: II 1 G Ex ia IIC T4 Ga Certificate Number Presafe 15ATEX6171</li> <li>IECEX: Ex ia IIC T4 Ga Certificate Number PRE 15.0011</li> <li>CSA classified, "C/US", as Intrinsically Safe. Exia. Class I, Groups A, B, C, &amp; D. Temperature Code T3A.</li> </ul> <div style="text-align: center;">  <p>C US 186718</p> </div>
<p>Power Supply</p>	<ul style="list-style-type: none"> <li>Three AA size alkaline batteries</li> </ul> <p>OR</p> <ul style="list-style-type: none"> <li>One lithium ion battery pack</li> </ul>
<p>Continuous Operating Hours @ 25 °C</p>	<ul style="list-style-type: none"> <li>Alkaline Batteries: 8 Hours (Non Alarm Operation, Fully Charged)</li> <li>Li-ion Battery Pack: 14 Hours (Non Alarm Operation, Fully Charged)</li> </ul>
<p>Case</p>	<p>High-impact Plastic, RF Shielded, Dust and Weather Proof</p>
<p>Included Accessories</p>	<ul style="list-style-type: none"> <li>Belt clip</li> <li>Rubber boot</li> <li>Wrist strap</li> <li>Tapered nozzle</li> <li>Screen protector</li> <li>3 foot hose and probe</li> <li>VOC zero filter (included for instruments with a low range PID sensor, a 10.0 eV/benzene PID sensor, an 11.7 eV PID sensor or any PID/IR CO<sub>2</sub> combination)</li> <li>Dehumidifier filter (included for instruments with an 11.7 eV PID sensor)</li> </ul>

Other Accessories	<ul style="list-style-type: none"> <li>• Alkaline Battery Pack</li> <li>• Rechargeable Li-ion Battery Pack</li> <li>• 115 VAC Charger</li> <li>• 12 VDC Charger</li> <li>• Hose/Probes of Various Lengths, See “General Parts List” on page 131.</li> <li>• VOC Zero Filter (optional for instruments with a high range PID sensor)</li> <li>• Dilution Fitting (1:1)</li> <li>• DIN Rail Mounting Assembly (for mounting chargers to the wall)</li> <li>• Product CD, includes Data Logger Management Program (Windows® 7, 8, and 10)</li> <li>• IrDA/USB Cable for connecting to a computer when using the Data Logger Management Program (not needed if computer has an infrared port)</li> </ul>
Dimensions and Weight	<p style="text-align: center;">Approximately 200(H) x 68(W) x 52(D) mm (7.9”H x 2.7”W x 2.0”D)  Approximately 400 g (14 oz.)</p>

---

## About this Manual

Although the GX-6000 can support up to 6 sensors, this manual specifically describes an instrument with the four standard sensors and a PID sensor. See the appendices for descriptions of other sensors.

The *GX-6000 Operator's Manual* uses the following conventions for notes, cautions, and warnings.

---

**NOTE:** Describes additional or critical information.

---

**CAUTION:** *Describes potential damage to equipment.*

**WARNING:** *Describes potential danger that can result in injury or death.*

The *GX-6000 Operator's Manual* is organized as follows:

- **Chapter 1** is an introduction to the GX-6000.
- **Chapter 2** describes the components of the GX-6000.
- **Chapter 3** describes the operation of the GX-6000.
- **Chapter 4** describes Calibration Mode which allows you to calibrate the GX-6000's active channels.
- **Chapter 5** describes the GX-6000's User Mode.
- **Chapter 6** describes the GX-6000's maintenance requirements and procedures.
- **Appendix A** describes Maintenance Mode which allows you to configure different parameters of the GX-6000.
- **Appendix B** describes Maintenance Mode 2 which allows you to change the **GAS COMB** and **HC SELECT** parameters.
- **Appendix C** describes the ESS-03 sensors and the operation of the GX-6000 with an ESS-03 sensor installed.
- **Appendix D** describes the IR sensors and the operation of the GX-6000 with an IR sensor installed.
- **Appendix E** describes the operation of the GX-6000 in Leak Check Mode.
- **Appendix F** describes the operation of the GX-6000 in Bar Hole Mode.
- **Appendix G** describes the operation of the GX-6000 in Inert Mode.
- **Appendix H** describes the 10.0 eV/benzene PID sensor.
- **Appendix I** describes the 11.7 eV PID sensor.

# Chapter 2: Description

## Overview

This chapter describes the GX-6000 instrument and accessories.

## Instrument Description

The GX-6000 includes the case, LCD, control buttons, flashlight LED, alarm LEDs, infrared communication port, buzzer, vibrator, printed circuit board, pump, flow chamber, sensors, filters, inlet filter holder, and batteries.

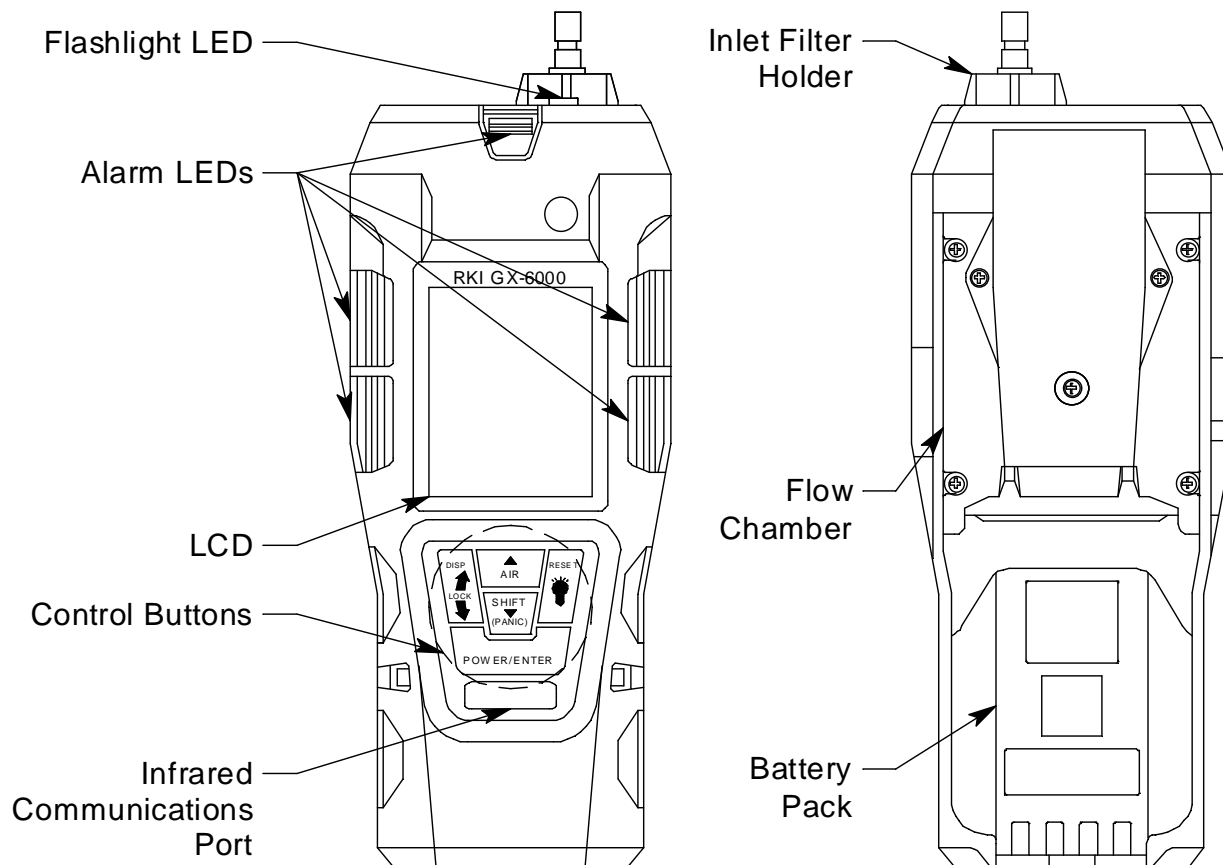


Figure 1: Component Location

### Case

The GX-6000's sturdy, high-impact plastic case is radio frequency (RF) resistant and is suitable for use in many environmental conditions, indoors and out. The case is dust proof and water resistant. A clear plastic window is located on the front of the case. The battery pack and flow chamber are located on the back of the GX-6000. The inlet filter holder is located on the top of the GX-6000 case.

### LCD

A digital LCD (liquid crystal display) is visible through a clear plastic window in the top case. The LCD simultaneously shows the gas reading for all installed sensors. The LCD also shows information for each of the GX-6000's operating modes.

## Control Buttons

Five control buttons are located below the LCD. They are, from left to right and top to bottom, DISP/LOCK, ▲AIR, SHIFT ▼ (PANIC), POWER/ENTER, and RESET.

**Table 3: GX-6000 Control Button Functions**

Button	Function(s)
DISP/LOCK	<ul style="list-style-type: none"><li>• activates Display Mode</li><li>• enters instructions into the GX-6000's microprocessor</li><li>• allows you to exit a menu without saving changes</li><li>• locks screen orientation in any mode if <b>INVERSION SELECT</b> is set to <b>ON</b></li></ul>
▲AIR	<ul style="list-style-type: none"><li>• activates the demand zero function (adjusts the GX-6000's fresh air reading)</li><li>• enters instructions into the GX-6000's microprocessor</li><li>• moves the cursor on the LCD up the screen</li><li>• increases the value of a parameter available for adjustment</li><li>• scrolls through parameter options</li></ul>
SHIFT ▼ (PANIC)	<ul style="list-style-type: none"><li>• enters instructions into the GX-6000's microprocessor</li><li>• moves the cursor on the LCD down the screen</li><li>• decreases the value of a parameter available for adjustment</li><li>• scrolls through parameter options</li><li>• initiates a Panic alarm in any mode if <b>PANIC</b> is set to <b>ON</b></li></ul>
POWER/ENTER	<ul style="list-style-type: none"><li>• turns the GX-6000 on and off</li><li>• enters instructions, values, and settings into the GX-6000's microprocessor</li></ul>
RESET	<ul style="list-style-type: none"><li>• silences and resets audible alarm if <b>ALARM LATCHING</b> is set to <b>LATCHING</b> and <b>ALARM SILENCE</b> is set to <b>ON</b></li><li>• turns the flashlight LED on and off</li></ul>

## Flashlight LED

A white LED is visible through a round, raised, frosted lens in the top of the case. This LED can be used to provide extra light, if necessary. The RESET button turns this LED on and off.

## Alarm LEDs

Five sets of red alarm LEDs (light emitting diodes) border the LCD. The alarm LEDs alert you to gas, low battery, and failure alarms.

## Infrared Communications Port

An infrared (IR) communications port is located on the front of the case, below the POWER/ENTER button. The data transmitted through the port is in standard IrDA protocol. A computer's infrared port or an IrDA/USB cable connected to a USB port can be used to download data saved by the GX-6000 to a computer using the GX-6000 Data Logger Management Program. See the GX-6000 Data Logger Management Program operator's manual for data logging and downloading instructions.



## Buzzer

One solid-state electronic buzzer is located inside the case. Holes on the top front of the case allow the sound to exit the case. The buzzer sounds for gas alarms, malfunctions, low battery voltage, and as an indicator during use of the GX-6000's many display and adjustment options.

## Vibrator

A vibrating motor inside the GX-6000 case vibrates for gas alarms, unit malfunctions, and as an indicator during normal use of the various modes of the GX-6000.

## Printed Circuit Boards (PCBs)

The GX-6000 printed circuit boards analyze, record, control, store, and display the information collected. The circuit boards are located inside the case. They are not user serviceable.

## Pump

A diaphragm pump inside the GX-6000 draws the sample to the sensors. It can draw sample from as far as 50 feet from the GX-6000. The pump is not user serviceable.

**CAUTION:** *Sample hose lengths of more than 50 feet are not recommended for the GX-6000 because of flow rate reduction.*

## Flow Chamber

The flow chamber is on the back of the GX-6000 and is held in place by four Phillips screws. The flow chamber seals to the rubber sensor gasket which seals to the sensor faces inside the GX-6000 and routes flow from the pump to the sensors and to the exhaust port (on the top of the GX-6000 case).

## Sensors

The GX-6000 uses five sensors to monitor combustible gas, oxygen (O<sub>2</sub>), carbon monoxide (CO), hydrogen sulfide (H<sub>2</sub>S), and isobutylene (IBL) simultaneously. The sensors are located inside the GX-6000 and are held in their sockets by the flow chamber. The sensors use different detection principles, as described below.

### Combustible Gas Sensor

The % LEL sensor detects combustible gas in the % LEL range. It uses a catalytic element for detection. The reaction of gas with oxygen on the catalyst causes a change in the resistance of the element which affects the current flowing through it. The current is amplified by the GX-6000's circuitry, converted to a measurement of combustible gas concentration, and displayed on the LCD.

The standard calibration for the combustible gas sensor is to methane but the sensor will still detect and respond to a variety of combustible gases.

### Oxygen Sensor

The O<sub>2</sub> sensor is a galvanic type of sensor. A membrane covers the cell and allows gas to diffuse into the cell at a rate proportional to the partial pressure of oxygen. The oxygen reacts in the cell and produces a voltage proportional to the concentration of oxygen. The voltage is measured by the GX-6000's circuitry, converted to a measurement of gas concentration, and displayed on the LCD.

## **CO and H<sub>2</sub>S Sensors**

The CO and H<sub>2</sub>S sensors are electrochemical cells that consist of two precious metal electrodes in a dilute acid electrolyte. A gas permeable membrane covers the sensor face and allows gas to diffuse into the electrolyte. The gas reacts in the sensor and produces a current proportional to the concentration of the target gas. The current is amplified by the GX-6000's circuitry, converted to a measurement of gas concentration, and displayed on the LCD.

### **PID Sensor**

Two types of PID sensors can be used with the GX-6000, a low range (higher sensitivity) sensor and a high range (lower sensitivity) sensor (see Table 1 for specifications).

The PID sensor is a cylindrical sensor with a diffusion opening on the front and 3 pins on the back. It is installed in a white housing that has three sockets on the bottom that mate with the GX-6000 instrument. The PID sensor must always be installed in the first smart sensor position which is located in the top left corner of the sensor block.

The standard calibration for a PID channel is to isobutylene. A PID channel can be factory setup for and calibrated to other gases. Regardless of the calibration gas, the PID channel will still detect and respond to a variety of volatile organic compounds (VOCs). Consult RKI Instruments, Inc. for other available PID configurations and to specify the desired PID configuration when a unit is ordered.

### **Dummy Sensors**

Any unit that has less than 6 sensors will have a dummy sensor installed in one or more unused sensor positions. Dummy sensors are factory installed. The flat top of the dummy sensor should face up and the bottom hollow side should face down.

### **Filters**

An H<sub>2</sub>S removal filter disk is placed into a recess in the sensor gasket over the %LEL sensor. It prevents H<sub>2</sub>S in the ambient air from reaching the unit's combustible gas sensor. Removing H<sub>2</sub>S that is present in the monitored air prolongs the life of the sensor. The H<sub>2</sub>S filter disk is dark red in color and although it may darken over time, its color is not indicative of remaining filter life. The H<sub>2</sub>S filter disk can absorb H<sub>2</sub>S for 33 ppm hours and should be replaced after that much exposure. With this many ppm hours of absorption, the H<sub>2</sub>S filter disk should be replaced after 80 minutes of exposure to 25 ppm H<sub>2</sub>S. This equates to replacing the H<sub>2</sub>S filter disk after 40 2-minute calibrations with a cylinder containing 25 ppm H<sub>2</sub>S. If H<sub>2</sub>S exists in the monitoring environment, the H<sub>2</sub>S filter disk will have to be replaced more frequently.

A charcoal filter is placed into a recess in the sensor gasket over the CO sensor. The charcoal filter is black, has a woven texture, and is impregnated with an H<sub>2</sub>S absorbing material. The CO sensor will respond if exposed to H<sub>2</sub>S and certain hydrocarbon gases. The charcoal filter disk scrubs these gases out of the sample to avoid false CO readings. If false or elevated CO readings are noticed, especially in the presence of H<sub>2</sub>S, change the charcoal filter.

## Inlet Filter Holder

The filter holder is a clear plastic dome shaped piece on the top of the case. A male quick connect fitting is located on the inlet filter holder. This is the GX-6000's inlet fitting. The filter holder may be removed by turning it counterclockwise and pulling it away from the case. One flat membrane disk hydrophobic filter, a wire mesh disk, and a rubber filter retaining gasket are held in place by the filter holder and are located in the bottom of the case chamber where the filter holder is installed.

## Batteries

Three AA-size alkaline batteries or a rechargeable lithium ion battery pack (4.1 VDC) power the GX-6000. Instrument run time is dependent upon battery type. At 25°C the alkaline batteries last at least 8 hours and the lithium ion battery pack lasts at least 14 hours. The battery icon in the upper right of the LCD shows remaining battery life.

When the GX-6000 detects a low battery voltage, a low battery warning is activated. When battery voltage is too low for Measuring Mode, the GX-6000 sounds a dead battery alarm.

The alkaline batteries can be replaced by removing the battery cover on the back of the case. The lithium ion pack can be replaced by removing the entire battery pack. The battery pack release latch is located on the bottom of the instrument. When viewing the instrument from the bottom with the LCD facing down, push the battery pack release latch toward the right to release the pack.

The lithium ion battery pack can be recharged by placing the GX-6000 in its battery charging station or by placing the battery pack in the charging station.

---

**NOTE:** Use of batteries or battery chargers not specified by RKI Instruments, Inc. will compromise the CSA classification and may void the warranty. See “Replacing or Recharging the Batteries” on page 102.

---

**WARNING:** *To prevent ignition of a hazardous atmosphere, batteries must only be changed or charged in an area known to be nonhazardous.*

**AVERTISSEMENT:** *Pour éviter l'inflammation d'une atmosphère dangereuse, les batteries doivent uniquement être modifiés ou facturés dans une zone connue comme non dangereuse.*

---

## Included Accessories

Included accessories consist of the tapered rubber nozzle, belt clip, rubber boot, wrist strap, and the sample hose/probe.

### Tapered Rubber Nozzle

A cone shaped 4 inch long rubber nozzle is included with the GX-6000 as standard. It can be installed on the inlet fitting by pushing the larger end over it. The smaller end can be inserted through a hole in a wall or some other access to an enclosed area to sample the environment.

### Belt Clip

A belt clip can be mounted to the back of the case using 3 Phillips head screws. The belt clip allows the GX-6000 to be securely attached to a belt.

### Rubber Boot

A protective rubber boot can be installed over the GX-6000.

### Wrist Strap

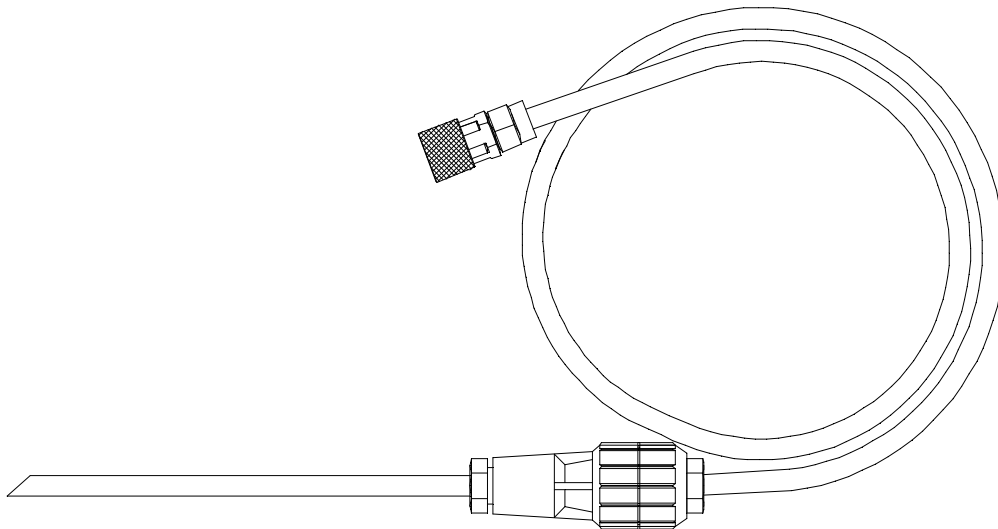
A wrist strap is included with the GX-6000 and can be attached to the right or left wrist strap installation feature on the GX-6000 case.

### Sample Hose and Probe

A 3 foot sample hose with an attached probe is standard with the GX-6000. When desired, the rubber nozzle may be removed and the sample hose and probe may be connected to the inlet fitting. Sample hose lengths are available from 3 feet to 50 feet (see “General Parts List” on page 131). The quick connect end of the sample hose connects to the inlet fitting of the GX-6000. The probe is integral with the hose and connects to it with a tube fitting.

**CAUTION:** *Sample hose lengths of more than 50 feet are not recommended for the GX-6000 because of flow rate reduction.*

The probe includes a replaceable particle filter and hydrophobic filter disk that prevent particulates and water from entering the GX-6000’s flow system. See “Replacing the Probe’s Particle Filter and Hydrophobic Filter Disk” on page 112 for instructions to replace the particle filter and hydrophobic filter disk.



**Figure 2: Sample Hose and Probe**

## Screen Protector

The clear screen protector can be installed over the GX-6000's LCD to prevent it from getting scratched.

1. Remove the GX-6000's rubber boot.
2. Orient the GX-6000 so that the LCD is as horizontal as possible.
3. Clean the LCD with rubbing alcohol.
4. Place 1 drop of water in the center of the LCD.
5. Grasp the tab at the top of the screen protector's backing and pull it away from the screen protector.
6. Use needle-nose pliers or tweezers to handle the screen protector.
7. Align the top of the screen protector with the top of the "RKI GX-6000" logo.
8. Press down on the center of the screen protector. Water should spread out along the entire surface of the screen protector between the screen protector and the LCD. Some of the water may come out the edges.
9. If you are unhappy with the initial placement of the screen protector, lift the screen protector up from a corner. Quickly rearrange the screen protector and set it back down on the LCD.
10. Use a small, stiff piece of plastic and, working your way out from center, remove any air bubbles. The screen protector may shift during this process so be sure to hold it securely with your other hand.
11. Allow enough time for the water between the screen protector and the LCD to dry before handling the GX-6000.
12. Reinstall the rubber boot.

---

## Other Accessories

Several other accessories are available for the GX-6000. This section describes the VOC zero filter, the dilution fitting, and the DIN rail. Detailed instructions regarding the use of the dilution fitting are included in other parts of this manual. Data logging accessories are briefly described in "Data Logging" on page 68.

### VOC Zero Filter

A VOC zero filter is included as standard with GX-6000s that include:

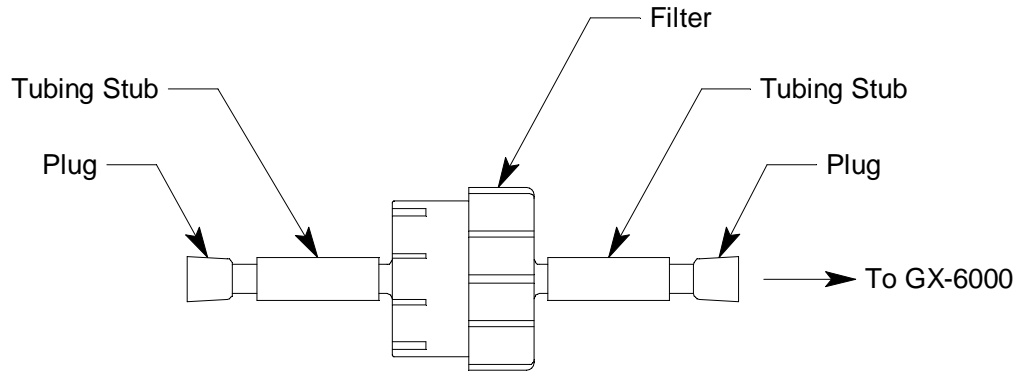
- Low range PID sensor (PID-001L)
- 10.0 eV/benzene PID sensor (PID-003L)
- 11.7 eV PID sensor (PID-004)
- Any PID sensor and any CO<sub>2</sub> sensor

The VOC zero filter scrubs out low levels of VOC gases using charcoal. Use the VOC zero filter when:

- Performing an air adjust on a PID sensor in an area that may have a low-level VOC background.
- Performing an air adjust on a PID/CO<sub>2</sub> instrument (in combination with a CO<sub>2</sub> scrubber).

The filter comes with a tubing stub and plug on each end. Both plugs must be removed before using the filter and must be reinstalled for storage. The filter does not have a preferred flow direction.

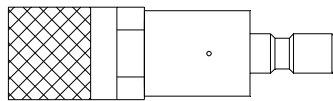
When used with a CO<sub>2</sub> scrubber, the VOC zero filter gets connected to the instrument and the CO<sub>2</sub> scrubber gets connected to the VOC zero filter. See “Performing a Demand Zero for Instruments with a Carbon Dioxide Sensor and a PID Sensor” on page 184 for more instructions.



**Figure 3: VOC Zero Filter**

### External Dilution Fitting

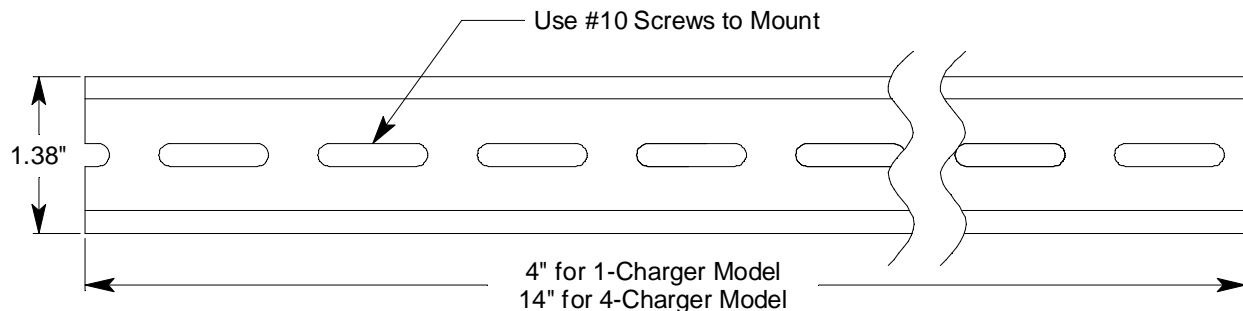
A 1:1 external dilution fitting is available for the GX-6000. It is designed to mate with the inlet fitting and accept the sample hose and probe. The fitting is made with brass and nickel plated brass and is appropriate for use with the four standard gases. The fitting is normally used when it is necessary to introduce air into a sample that has no oxygen or a very low level of oxygen, such as a nitrogen purged sample. It can also be used when one of the target gas levels in the sample area will likely be present in a concentration above the detection range for that gas. Since the fitting partially consists of unplated brass, it is not appropriate for detection of elevated levels of H<sub>2</sub>S or of gases that are easily absorbed such as Cl<sub>2</sub> or SO<sub>2</sub>.



**Figure 4: 1:1 Dilution Fitting**

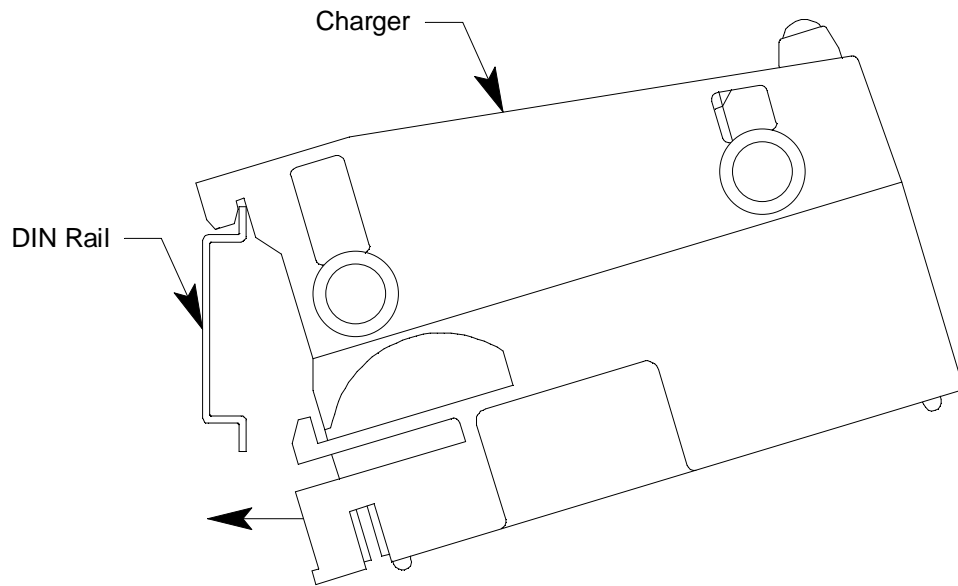
### DIN Rail Mounting Assembly

Two different DIN rail mounting assemblies are available for the GX-6000’s charger. Each assembly has two end clamps but one assembly is long enough to accommodate 1 charger and the other assembly is long enough to accommodate 4 chargers.



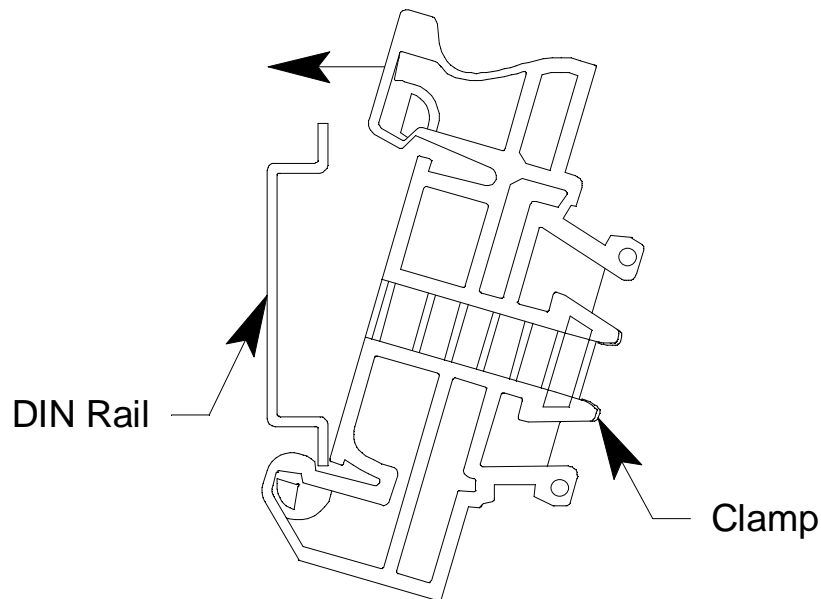
**Figure 5: DIN Rail Dimensions**

- 1 . Use #10 screws to mount the DIN rail to the wall.
- 2 . Install the charger(s) on the DIN rail. Seat the top of the DIN rail in the top slot on the back of the charger. Press the bottom of the charger toward the DIN rail until it locks into place.

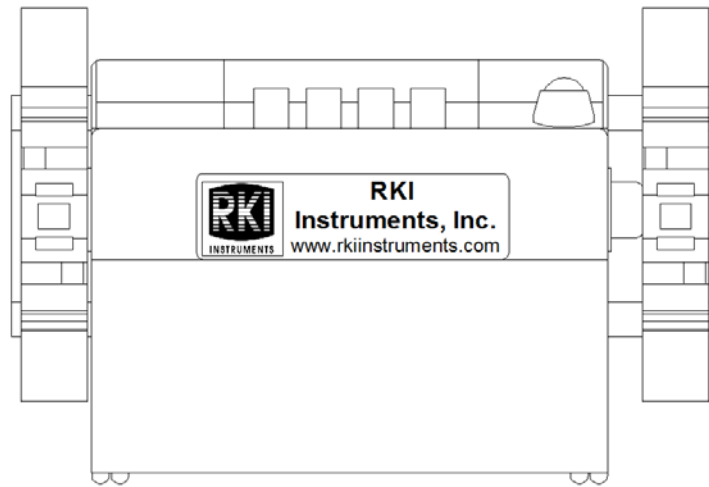


**Figure 6: Installing a Charger on the DIN Rail**

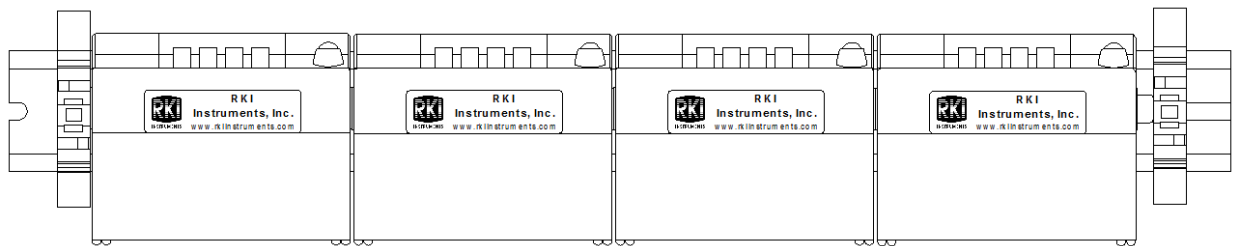
- 3 . Slide the charger(s) along the DIN rail into the desired position.
- 4 . Install the end clamps on the left and right side of the charger or bank of chargers to prevent sliding.



**Figure 7: Clamp Installation**

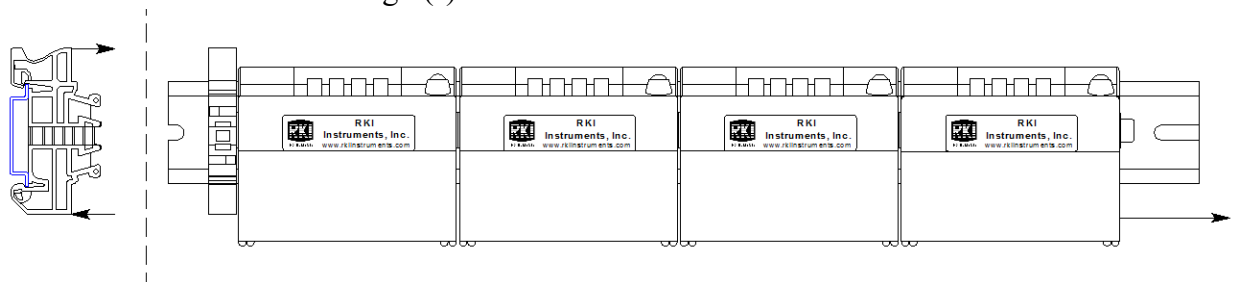


**Figure 8: 1-Charger Installation**



**Figure 9: 4-Charger Installation**

5. To remove any charger(s) from the DIN rail:
  - a. Remove the clamps by pushing on the bottom of the clamp and pulling on the top of the clamp.
  - b. Slide the charger(s) off the DIN rail.



**Figure 10: Charger Removal**



# Chapter 3: Operation

---

## Overview

This chapter explains how to use the GX-6000 to perform confined space entry monitoring or general area monitoring in Normal Mode. There are three operational modes in Normal Mode: Measuring Mode, Display Mode, and Calibration Mode. While in Normal Mode, the unit is normally operating in Measuring Mode. Display Mode and Calibration Mode are accessible from Measuring Mode. Display Mode is described in this chapter. Calibration Mode is described in “Chapter 4: Calibration Mode” on page 70.

The GX-6000 can also operate in Leak Check Mode and Bar Hole Mode. See “Appendix E: Using the GX-6000 in Leak Check Mode” for operating instructions for Leak Check Mode. See “Appendix F: Using the GX-6000 in Bar Hole Mode” on page 198 for operating instructions for Bar Hole Mode.

---

## Start Up

This section explains how to start up the GX-6000, get it ready for operation, and turn it off.

---

**NOTE:** The screens illustrated in this section are for a standard 4-gas + high range PID unit. The screens displayed by your GX-6000 may be slightly different.

---

### Turning On the GX-6000

To illustrate certain functions, the following description of the GX-6000 start up sequence assumes that the following menu items in Maintenance Mode are turned on: **LUNCH BREAK**, **CAL REMINDER**, **BUMP REMINDER**, and **ID DISPLAY**. If any of these items are turned off, then the corresponding screens will not appear.

The GX-6000 may be used with a sample hose and probe or with the tapered rubber nozzle. Determine which configuration works best for your application.

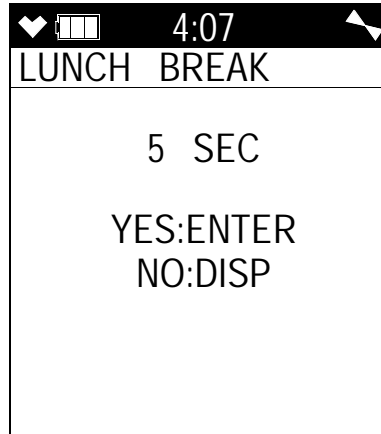
---

**NOTE:** When the sample hose is not being used, its outgassing characteristics may result in a small buildup of gas to which the PID sensor will respond. If a sample hose has been sitting unused for a period of time, when that sample hose is connected to a GX-6000, the PID channel may temporarily show a reading. The reading will return to a fresh air reading after all of the built up gas has been drawn out of the sample hose.

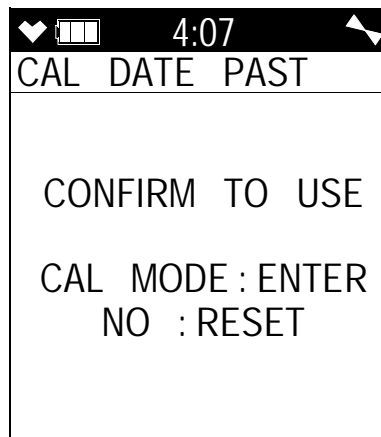
---

- 1 . Connect the tapered rubber nozzle or the sample hose and probe to the GX-6000's quick connect inlet fitting.
- 2 . Press and briefly hold down the POWER/ENTER button. Release the button when you hear a beep.

3. If **LUNCH BREAK** is turned on (see “Updating the Lunch Break Setting” on page 152), the Lunch Break Screen appears. The unit counts down from 5 seconds at the top of the screen.



- To continue accumulating peak and time-weighted average (TWA) readings from the last time the GX-6000 was used, press and release the POWER/ENTER button before the countdown reaches 0 or allow the countdown to reach 0. If you do not press the POWER/ENTER button within the 5 second countdown, the GX-6000 automatically resumes accumulating the peak and TWA readings. The GX-6000 will also continue to keep track of operating time including the operating time from the last time the GX-6000 was used. See “Time in Operation Screen” on page 55 for more information about how the GX-6000 tracks the operating time. The short-term exposure limit (STEL) reading is reset each time the GX-6000 is turned on.
  - To reset the accumulation of these measurements, press and release the DISP/ LOCK button before the countdown reaches 0.
4. If **CAL REMINDER** is set to **ON**, the screen that appears next depends on how **CAL EXPRD** is set in Maintenance Mode (see “Updating the Calibration Expired Setting” on page 143).
- If the unit is due for calibration and **CAL EXPRD** is set to **CONFIRM TO USE**, then the following screen displays and the buzzer sounds in a double pulsing pattern.

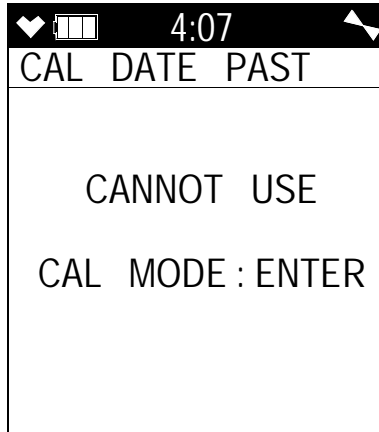


To perform a calibration, press and release the POWER/ENTER button. The GX-6000 will enter Calibration Mode and the LCD will show the Calibration Mode main menu. See “Chapter 4: Calibration Mode” on page 70 for

instructions to calibrate the GX-6000. When you are done with the calibration and exit Calibration Mode, the unit will begin the startup sequence. If the calibration was successful, the screen above will not appear again until the unit is due for calibration. If the calibration was not successful, the screen above will again appear in the startup sequence.

To continue without performing a calibration, press and release the RESET button.

- If the unit is due for calibration and **CAL EXPRD** is set to **CANNOT USE**, then the following screen displays and the buzzer sounds in a double pulsing pattern.



The GX-6000 cannot be used until a successful calibration has been performed. Press and release the POWER/ENTER button to enter Calibration Mode. See “Chapter 4: Calibration Mode” on page 70 for instructions to calibrate the GX-6000.

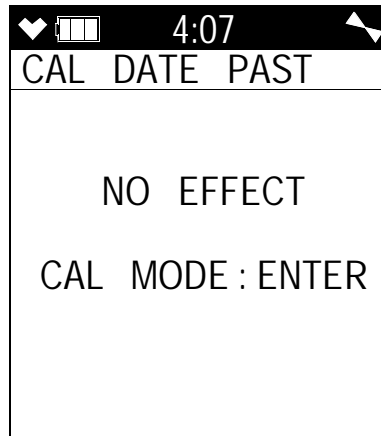
---

**NOTE:** In this situation, even if the User password function has been turned on, no password is required to perform a calibration.

---

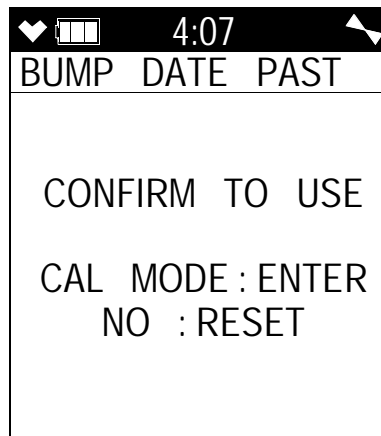
When you are done with the calibration and exit Calibration Mode, the unit will begin the startup sequence. If the calibration was successful, the screen above will not appear again until the unit is due for calibration. If the calibration was not successful, the screen above will again appear in the startup sequence.

- If the unit is due for calibration and **CAL EXPRD** is set to **NO EFFECT**, then the following alert screen displays and the buzzer sounds in a double pulsing pattern.



If you want to enter Calibration Mode, press and release the POWER/ENTER button. If you do not want to enter Calibration Mode, wait for the instrument to continue with its startup sequence.

5. If **BUMP REMINDER** is set to **ON** (factory setting is **OFF**), the screen that appears next depends on how **BUMP EXPRD** is set in Maintenance Mode (see “Updating the Bump Expired Setting” on page 147).
  - If the unit is due for bump testing and **BUMP EXPRD** is set to **CONFIRM TO USE**, then the following screen displays and the buzzer sounds in a double pulsing pattern.



To perform a bump test, press and release the POWER/ENTER button. The GX-6000 will enter Calibration Mode and the LCD will show the Calibration Mode main menu. See “Chapter 4: Calibration Mode” on page 70 for instructions to bump test the GX-6000. When you are done with the bump test and exit Calibration Mode, the unit will begin the startup sequence. If the bump test was successful, the screen above will not appear again until the unit is due for bump testing. If the bump test was not successful, the screen above will again appear in the startup sequence.

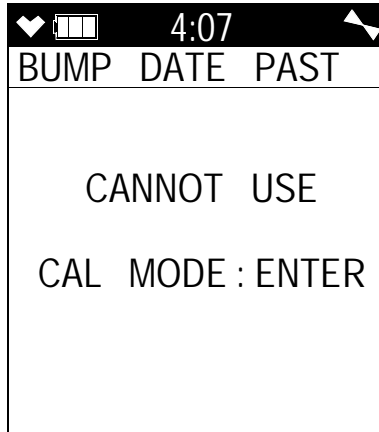
To continue without performing a bump test, press and release the RESET button.

---

**NOTE:** If **BUMP DISP** is set to **OFF**, the bump test menu item will not appear in Calibration Mode even though the instrument is prompting you to perform a bump test. A bump test can always be performed in Maintenance Mode, if necessary.

---

- If the unit is due for bump testing and **BUMP EXPRD** is set to **CANNOT USE**, then the following screen displays and the buzzer sounds in a double pulsing pattern.



The GX-6000 cannot be used until a successful bump test has been performed. Press and release the POWER/ENTER button to enter Calibration Mode. See “Chapter 4: Calibration Mode” on page 70 for instructions to bump test the GX-6000.

---

**NOTE:** In this situation, even if the User password function has been turned on, no password is required to perform a bump test.

---

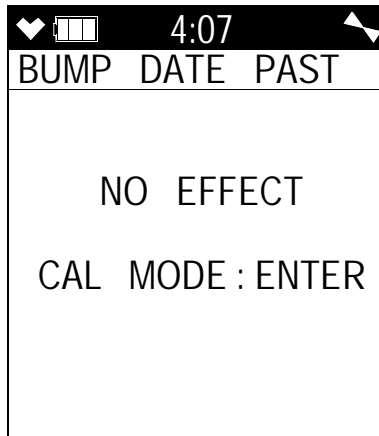
---

**NOTE:** If **BUMP DISP** is set to **OFF**, the bump test menu item will not appear in Calibration Mode even though the instrument is prompting you to perform a bump test. A bump test can always be performed in Maintenance Mode, if necessary.

---

When you are done with the bump test and exit Calibration Mode, the unit will begin the startup sequence. If the bump test was successful, the screen above will not appear again until the unit is due for bump testing. If the bump test was not successful, the screen above will again appear in the startup sequence.

- If the unit is due for bump testing and **BUMP EXPRD** is set to **NO EFFECT**, then the following alert screen displays and the buzzer sounds in a double pulsing pattern.



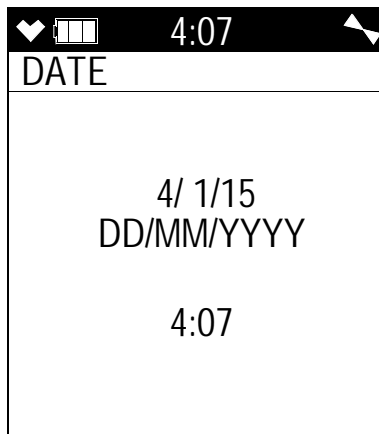
If you want to enter Calibration Mode, press and release the POWER/ENTER button. If you do not want to enter Calibration Mode, wait for the instrument to continue with its startup sequence.

---

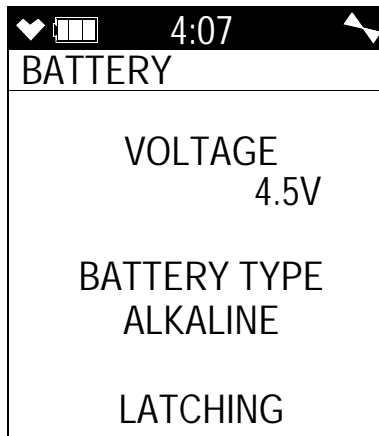
**NOTE:** If **CAL REMINDER** or **BUMP REMINDER** or both are set to **OFF**, a WARM-UP screen will display before the warm up sequence continues.

---

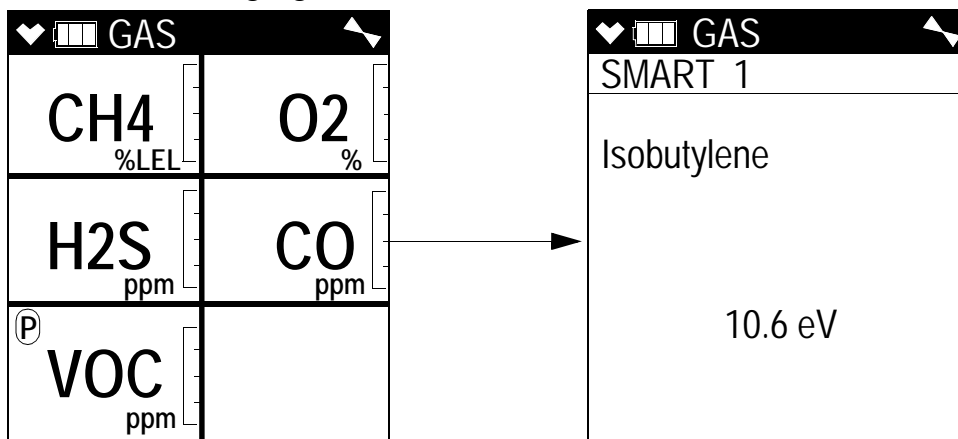
6. The Date/Time Screen appears for a few seconds.



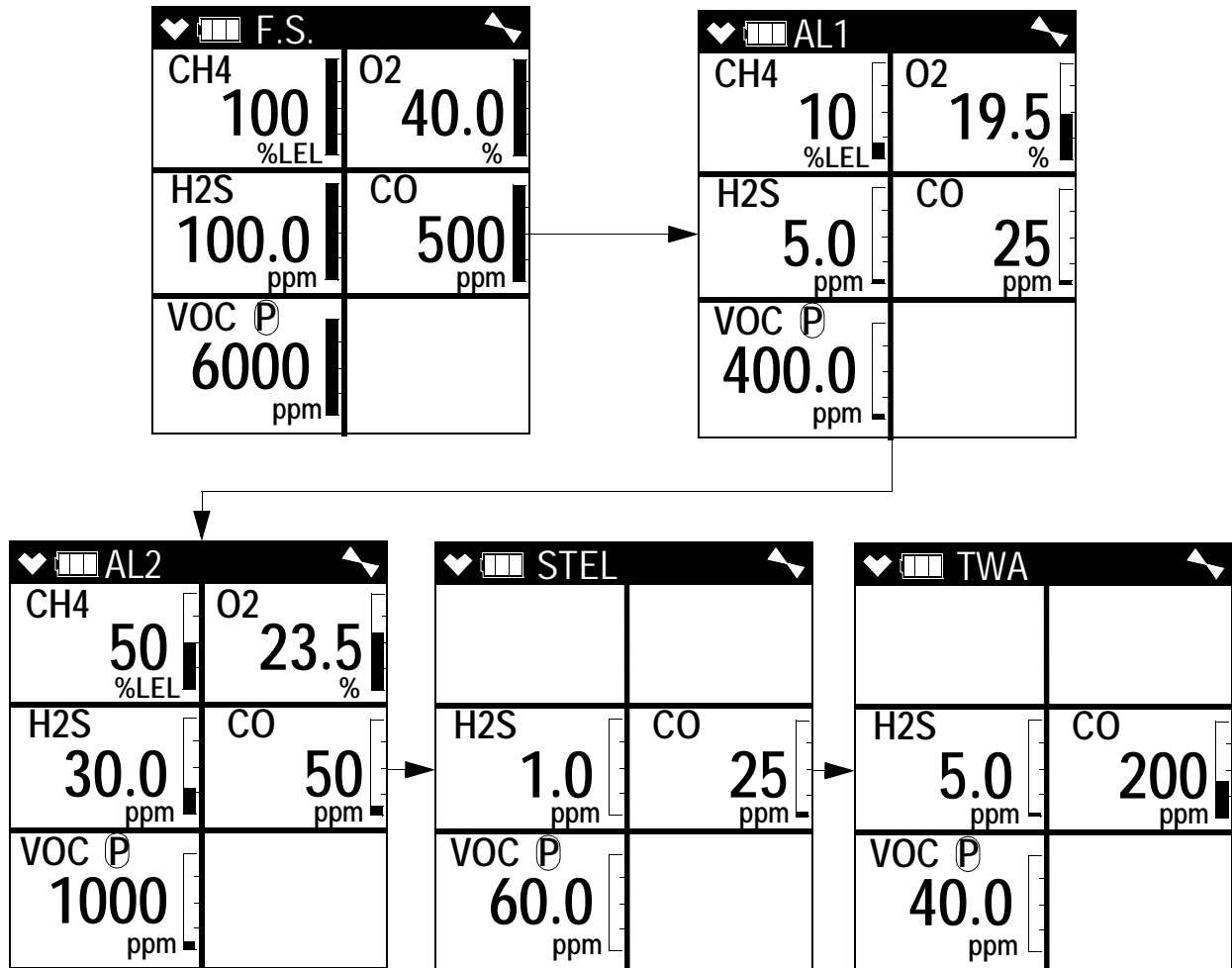
7. The Battery Voltage Screen appears for a few seconds.



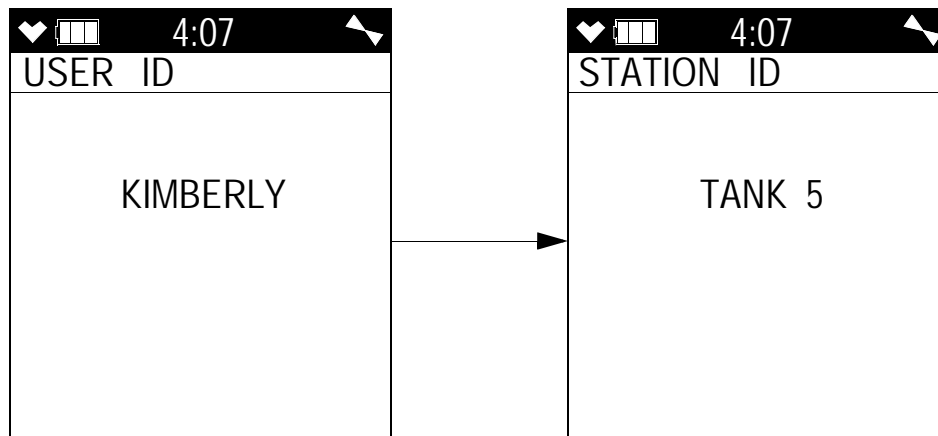
8. The Active Gases Screen appears for a few seconds indicating which channels are active and their target gas.



9. The full scale values and the gas alarm setpoints are displayed by five screens in sequence: the Full Scale Screen, the Low Alarm Screen, High Alarm Screen, STEL Alarm Screen, and TWA Alarm Screen. Each screen remains on the LCD for three seconds.



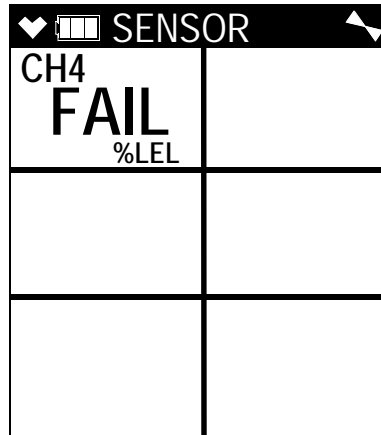
10. If **ID DISPLAY** is set to **ON** (see “Turning the User/Station ID Function On or Off” on page 151), the User ID Screen appears for a few seconds, followed by the Station ID Screen.



If **ID DISPLAY** is set to **OFF**, these screens will not appear.



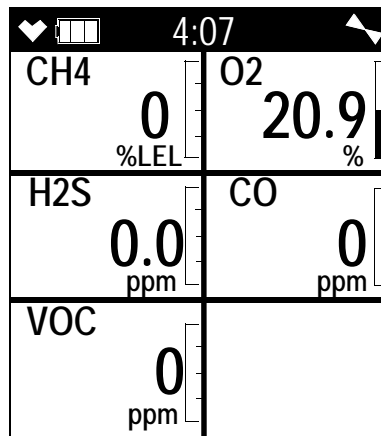
- 11 . If the GX-6000 experiences a sensor failure during start up, a screen indicating which sensor failed appears and the buzzer sounds a double pulsing tone once per second. In the example below, the CH<sub>4</sub> sensor has failed.



If you wish to continue, press and release the RESET button to acknowledge the failure. The gas reading for the failed sensor will be replaced by “- - -”. Replace the failed sensor as soon as possible.

- 12 . The GX-6000 is now monitoring for gas in Measuring Mode. The Measuring Mode Screen appears displaying the current gas reading for each target gas. If you have 2 PID sensors installed, they might both be displayed as “VOC”. The channel that appears first is based on the following sensor priority.

High Priority  ↓  Low Priority	10.6 eV low range PID
	10.0 eV/benzene PID
	11.7 eV PID
	10.6 eV high range PID



## Performing a Demand Zero

Before using the GX-6000, it is recommended to set the fresh air readings for the target gases by performing a demand zero. This will set the CH<sub>4</sub>, H<sub>2</sub>S, CO, and PID channels to zero and the OXY channel to 20.9%.

1. Find a fresh-air environment. This is an environment free of toxic or combustible gases and of normal oxygen content (20.9%).
2. Turn on the unit as described above in “Turning On the GX-6000”.
3. If you suspect any low-level VOC background in the area, you will need to use the VOC zero filter.

---

**NOTE:** If you have both a PID and a CO<sub>2</sub> sensor installed, you will need to follow the directions in “Performing a Demand Zero for Instruments with a Carbon Dioxide Sensor and a PID Sensor” on page 184 instead of following the directions shown below.

---

- a. Remove the plug from each end of the VOC zero filter.
  - b. Attach the VOC zero filter to the inlet fitting or probe. The filter does not have a preferred flow direction.
  - c. Let the instrument draw through the VOC zero filter for 1 minute before continuing.
4. Press and hold the ▲AIR button. The LCD prompts you to continue holding the ▲AIR button and the buzzer will pulse while you hold the button.
  5. Continue to hold the ▲AIR button until the LCD prompts you to release it. The GX-6000 will set the fresh air reading for all channels. Start up is complete and the unit is now ready for monitoring.
  6. If the VOC zero filter was used, remove the filter from the GX-6000’s inlet fitting or probe. Reinstall the plugs on each end of the filter.

## Turning Off the GX-6000

1. Press and hold the POWER/ENTER button.
2. TURN OFF will appear on the display and the buzzer will pulse for about five seconds.
3. Release the button when TURN OFF disappears from the display.

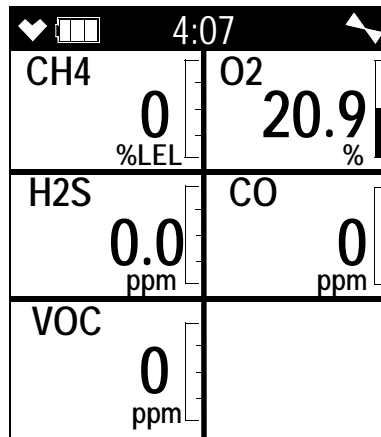
---

## Measuring Mode, Normal Operation

When the GX-6000 completes its startup sequence, it is in Measuring Mode. In Measuring Mode the GX-6000 continuously monitors the sampled atmosphere and displays the gas concentrations present for its target gases. In a low-light environment, press and release any button to turn on the display backlight. See “Updating the Backlight Time Setting” on page 151 to program backlight duration. If **CONFIRMATION** is set to **ON** in the Maintenance Mode menu (see “Updating the Confirmation Alert Setting” on page 153), the GX-6000 beeps periodically to confirm that it’s operating.

### Monitoring an Area

1. Start up the GX-6000 as described above in “Start Up” on page 25. It is now in Measuring Mode.



2. Take the GX-6000 to the monitoring area.  
Put the probe tip in the area to be monitored.

---

**NOTE:** If the particle filter or hydrophobic filter become dirty or clogged, replace them. If water enters the probe, dry out or replace the particle filter (if installed) and shake any water out of the probe and off of the hydrophobic filter. If you notice that water has entered the flow system through the probe, replace the probe’s hydrophobic filter. See “Replacing the Probe’s Particle Filter and Hydrophobic Filter Disk” on page 112 for instructions to replace the particle filter and the hydrophobic filter.

---

3. Wait 10 - 15 seconds and observe the display for gas readings. If a reading is observed, allow the reading to stabilize to determine the gas concentrations present.

---

**NOTE:** Response time increases with the length of the sample hose. Long sample hoses will require more time to show a response at the GX-6000. The maximum sample hose length recommended for the GX-6000 is 50 feet. Consult RKI Instruments, Inc. for longer sample hose lengths.

---

4. If a gas alarm occurs, take appropriate action. See “Responding to Alarms” on page 43.

## Using Optional Sample Hoses

The standard sample hose for the GX-6000 is 3 feet long. Optional sample hoses and probes with longer hoses are available from 5 - 50 feet in 5 foot increments (see “General Parts List” on page 131). If you are considering using a hose and probe with a longer hose, keep in mind that a longer hose will increase the GX-6000’s response time and the flowrate may decrease close to the low flow alarm point.

**CAUTION:** *Sample hose lengths of more than 50 feet are not recommended for the GX-6000 because of flow rate reduction and increased response time. Consult RKI Instruments, Inc. for hose lengths longer than 50 feet.*

The chart below illustrates how response time is affected by the sample hose length.

**Table 4: GX-6000 Response Time vs. Sample Hose Length**

Hose Used	Typical Time to 90% of Response (T90)
Probe & 3 Foot Hose (standard)	10 seconds
Probe & 10 Foot Hose	15 seconds
Probe & 30 Foot Hose	30 seconds
Probe & 50 Foot Hose	40 seconds

## Combustible Gas Detection

There are three issues to keep in mind when monitoring for combustible gas.

- The catalytic combustible sensor will respond to any combustible gas. The standard calibration gas for the GX-6000 catalytic combustible channel is methane (CH<sub>4</sub>). If the instrument is calibrated to a different combustible gas, such as hexane or propane, the gas name for the catalytic combustible channel will reflect the target gas.

The table below lists the conversion factors for several hydrocarbon gases **if the GX-6000 is calibrated to methane**. To use this table, multiply the display reading on the combustible gas channel by the factor in the appropriate row to obtain the actual gas concentration. For example, if you are detecting pentane and the display reads 10% LEL for the catalytic combustible channel, you actually have 10% LEL x 1.56 = 15.6% LEL pentane present.

**Table 5: LEL Hydrocarbon Conversions**

Gas	LEL Conversion Factor (CH <sub>4</sub> Cal.)
Acetone	1.79
Acetylene	1.92
Benzene	2.00
Ethane	1.09
Ethanol	2.50
Ethylene	1.06
Heptane	2.50
Hexane	2.08
Hydrogen	1.25
IPA	2.78

Gas	LEL Conversion Factor (CH <sub>4</sub> Cal.)
Iso Butane	1.47
MEK	2.27
Methane	1.00
Methanol	1.92
Pentane	1.56
Propane	1.35
Propylene	1.32
Toluene	3.13
Xylene	4.27

- The GX-6000 provides the catalytic combustible sensor with some protection against exposure to high levels of combustible gas which can damage the sensor. It does this by turning off the combustible sensor power temporarily when it determines that an over scale (more than 100 %LEL) concentration of combustible gas is present that may damage the sensor. Nevertheless, concentrations of combustible gas of more than 100 %LEL can still affect the zero level or calibration of the combustible sensor if the concentration is high enough.

**CAUTION:** *Do not expose the catalytic combustible sensor to high concentrations of combustible gas such as that from a butane lighter. Exposure to high concentrations of combustible gas may adversely affect the performance of the sensor.*

**CAUTION:** *Any rapid increase in the combustible gas reading on the catalytic combustible channel followed by a declining or erratic reading may indicate a gas concentration above the LEL which may be hazardous.*

- Some gases such as silicone vapors, chlorinated hydrocarbons, and sulphur compounds can contaminate the detection elements inside the combustible sensor damaging the sensor and result in reduced response to combustible gas. Make every effort to avoid these gases.

## VOC Detection

When monitoring for VOCs using the PID sensor, keep the following in mind:

- Regardless of what gas the PID sensor is calibrated to (factory calibration is to isobutylene), the PID sensor will still detect and respond to a variety of volatile organic compounds (VOCs).
- The PID channel will indicate an upscale reading if one of a variety of combustible gases is present. If %LEL concentrations of one of these combustible gases is present, the PID channel may indicate an overscale reading.
- If concentrations of methane greater than 10% LEL are present in the monitoring environment, the PID channel's reading will be suppressed.
- The PID sensor will also respond to H<sub>2</sub>S and NH<sub>3</sub>, so if H<sub>2</sub>S or NH<sub>3</sub> is present, the PID channel may indicate an upscale reading depending on the concentration present.
- If your instrument has both a low range PID sensor and a high range PID sensor installed and if you are monitoring for gases in the higher range, the low range PID channel may be in over range alarm while monitoring, depending on the level of VOCs present.
- If you have 2 PID sensors installed, they might both be displayed as "VOC". The channel that appears first is based on the following sensor priority.

High Priority	10.6 eV low range PID
↓	10.0 eV/benzene PID
↓	11.7 eV PID
Low Priority	10.6 eV high range PID

---

**NOTE:** If you have changed the factory-set channel assignments using the **CONFIGURE CH** menu item in User Mode, the order of displayed sensors may be different and you will need to remember how you set your instrument up.

---

## Oxygen Detection

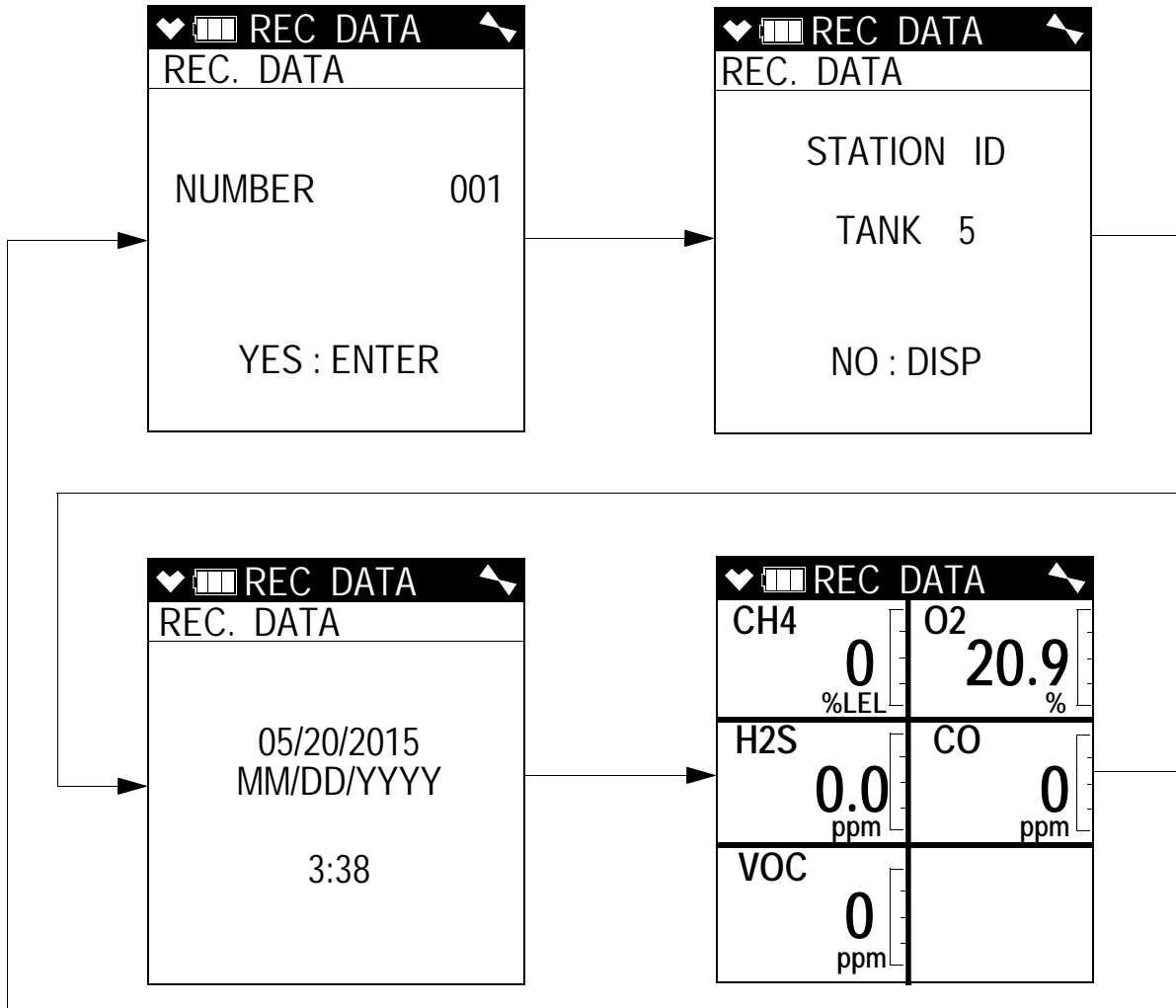
Exposing the galvanic oxygen sensor to halogen gas or sulfides may shorten the sensor's life or cause malfunctions or inaccurate gas readings. Minimize the sensor's exposure to these gases as much as possible. If exposure occurs, allow the instrument to draw fresh air and confirm that the readings return to fresh air values.

## Snap Log Mode

The snap logging function in Snap Log Mode allows the user to record data at a specific time and have it saved to the data logger. The data is assigned a snap log ID and is saved with the station ID that was in use when the data was taken.

To enter Snap Log Mode and record snap log data:

1. While the unit is in Measuring Mode, press and hold the SHIFT ▼ (PANIC) button, then press and hold the ▲AIR button and hold both until you hear a beep. The unit will cycle through the following screens.



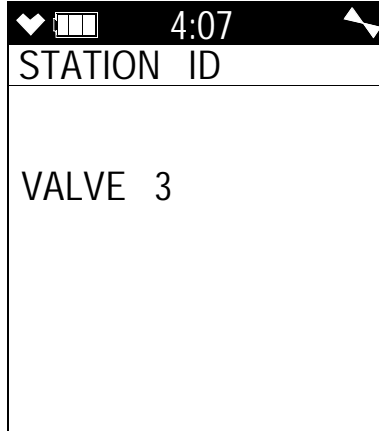
The first screen displays what snap log ID will be given to this particular set of data and that you should press the POWER ENTER button to save a set of snap log data. The snap log ID number increases sequentially with each set of snap log data taken. The second screen displays what Station ID will be associated with this snap log and that you should press the DISP/LOCK button to exit Snap Log Mode without saving a set of snap log data. The third screen displays the year, month, day, and time of the snap log. The fourth screen displays the current gas readings.

---

**NOTE:** If the GX-6000 detects an alarm condition while in Snap Log Mode, it will automatically exit Snap Log Mode and return to Measuring Mode. You may then reenter Snap Log Mode and take snap logs while the instrument is still in alarm.

---

2. You can change the Station ID to be used with the snap log by pressing the SHIFT ▼ (PANIC) button and then pressing the DISP/LOCK button. The Station ID Select Screen will appear and the current Station ID will be flashing.



3. Use the ▲AIR and SHIFT ▼ (PANIC) buttons to scroll to the desired Station ID, then press and release the POWER/ENTER button to return to the Snap Logging Screen sequence.  
To return to the Snap Logging Screen sequence without changing the Station ID, press and release the DISP/LOCK button.
4. To take a snap log of the current gas readings, press and release the POWER/ENTER button. The unit will display SAVED along the bottom of the screen before returning to the Snap Logging Screen sequence.  
To exit Snap Log Mode without taking a snap log or when you are finished recording snap logs, press and release the DISP/LOCK button. The unit will immediately return to the Measuring Mode Screen.  
The data recorded in Snap Log Mode can be viewed in Display Mode. See “Viewing Snap Logger Data” on page 62 for more information.



---

## Measuring Mode, Alarms

This section covers alarm indications in Measuring Mode. It also describes how to reset the GX-6000 after an alarm has occurred and how to respond to an alarm condition.

---

**NOTE:** False alarms may be caused by radio frequency (RF) or electromagnetic (EMI) interference. Keep the GX-6000 away from RF and EMI sources such as radio transmitters or large motors.

---

### Alarm Indications

The GX-6000 buzzer will sound an alarm, the LEDs will flash, and the vibrator will pulse when any sort of alarm condition or failure is encountered.

---

**NOTE:** If an alarm condition occurs while you are in Display Mode, the GX-6000 will automatically bring up the alarm screen instead.

---

The table below summarizes the types of alarms produced by the GX-6000 and their indications.

None of the Man Down alarm indications will happen if **MAN DOWN** is set to **OFF** in Maintenance Mode (factory setting).

**Table 6: Alarm Types and Indications**

Alarm Type	Visual Indications	Other Indications
<b>Low Alarm</b> Concentration of gas rises above the Low Alarm setting or falls below the Low Alarm setting for O <sub>2</sub> .	<ul style="list-style-type: none"><li>Affected channel display alternates between gas reading and <b>AL1</b></li><li>Alarm LED arrays flash in circle sequence once per second</li><li>Backlight turns on</li></ul>	<ul style="list-style-type: none"><li>High-low tone sounding twice per second</li><li>Vibrator pulses once per second</li></ul>
<b>High Alarm</b> Concentration of gas rises above the High Alarm setting.	<ul style="list-style-type: none"><li>Affected channel display alternates between gas reading and <b>AL2</b></li><li>Alarm LED arrays flash in circle sequence twice per second</li><li>Backlight turns on</li></ul>	<ul style="list-style-type: none"><li>High-low tone sounding four times per second</li><li>Vibrator pulses twice per second</li></ul>
<b>TWA or STEL</b> Concentration of CO, H <sub>2</sub> S, or high range VOC rises above the TWA or STEL alarm setting.	<ul style="list-style-type: none"><li>Affected channel display alternates between gas reading and <b>TWA or STEL</b></li><li>Alarm LED arrays flash in circle sequence once per second</li><li>Backlight turns on</li></ul>	<ul style="list-style-type: none"><li>High-low tone sounding twice per second</li><li>Vibrator pulses once per second</li></ul>

**Table 6: Alarm Types and Indications**

Alarm Type	Visual Indications	Other Indications
<b>Over Range</b>	<ul style="list-style-type: none"> <li>• Affected channel display alternates between <b>OVER</b> displayed where the gas reading normally is and <b>OVER</b> displayed where the reading units normally are</li> <li>• Alarm LED arrays flash in circle sequence twice per second</li> <li>• Backlight turns on</li> </ul>	<ul style="list-style-type: none"> <li>• High-low tone sounding four times per second</li> <li>• Vibrator pulses twice per second</li> </ul>
<b>Low Flow</b>	<ul style="list-style-type: none"> <li>• The display indicates <b>FAIL LOW FLOW</b></li> <li>• Alarm LED arrays flash once per second</li> <li>• Backlight turns on</li> </ul>	Double pulsing tone once per second
<b>Low Battery Warning</b>	<ul style="list-style-type: none"> <li>• The last bar in the battery icon disappears and the battery icon starts flashing</li> </ul>	None
<b>Dead Battery Alarm</b>	<ul style="list-style-type: none"> <li>• Gas readings disappear and <b>FAIL BATTERY</b> appears at the top of the screen</li> <li>• Alarm LED arrays flash once per second</li> </ul>	Double pulsing tone once per second
<b>Sensor Failure</b>	<ul style="list-style-type: none"> <li>• <b>SENSOR</b> appears at the top of the screen and the failed sensor(s) are indicated with <b>FAIL</b> under the gas name.</li> <li>• Alarm LED arrays flash once per second</li> </ul>	Double pulsing tone once per second
<b>Clock Failure</b>	<ul style="list-style-type: none"> <li>• <b>FAIL CLOCK</b> appears at the top of the screen</li> <li>• Alarm LED arrays flash once per second</li> </ul>	Double pulsing tone once per second
<b>System Failure</b>	<ul style="list-style-type: none"> <li>• <b>FAIL SYSTEM</b> appears at the top of the screen and an error code displays below it</li> <li>• Alarm LED arrays flash once per second</li> </ul>	Double pulsing tone once per second

**Table 6: Alarm Types and Indications**

Alarm Type	Visual Indications	Other Indications
<p><b>Man Down Warning 1</b> The WARNING 1 TIME defined in Maintenance Mode has passed since the instrument detected movement.</p>	<ul style="list-style-type: none"> <li>Alarm LED arrays flash once per second</li> </ul>	<p>Single pulsing tone once per second</p>
<p><b>Man Down Warning 2</b> The WARNING 2 TIME defined in Maintenance Mode has passed since the instrument detected movement.</p>	<ul style="list-style-type: none"> <li>Alarm LED arrays flash twice per second</li> </ul>	<p>Single pulsing tone twice per second</p>
<p><b>Man Down Alarm</b> The ALARM TIME defined in Maintenance Mode has passed since the instrument detected movement.</p>	<ul style="list-style-type: none"> <li><b>MAN DOWN</b> flashes at top of screen in place of time</li> <li>Alarm LED arrays flash in circle sequence twice per second</li> </ul>	<ul style="list-style-type: none"> <li>High-low tone sounding twice per second</li> <li>Vibrator pulses twice per second</li> </ul>
<p><b>Panic</b> User presses and holds the SHIFT ▼ (PANIC) button.</p>	<ul style="list-style-type: none"> <li>Screen unaffected for 5 seconds before alarm starts</li> <li><b>MAN DOWN</b> flashes at top of screen in place of time</li> <li>Alarm LED arrays flash in circle sequence twice per second</li> <li>Backlight turns on</li> </ul>	<ul style="list-style-type: none"> <li>Single pulsing tone twice per second for 5 seconds before alarm starts</li> <li>High-low tone sounding twice per second</li> <li>Vibrator pulses twice per second</li> </ul>

## Responding to Alarms

This section describes response to gas, over range, battery, sensor failure, clock failure, system failure, man down, and panic alarms.

### *Responding to Gas Alarms*

- Determine which gas alarm has been activated.
- Follow your established procedure for an increasing gas condition or a decreasing oxygen condition.

- Reset or silence the alarm as necessary or allowed. Table 7 below summarizes resetting and silencing alarms for all **ALARM LATCHING** and **ALARM SILENCE** combinations that are possible. See “Updating the Alarm Latching Setting” on page 150 and “Updating the Alarm Silence Setting” on page 150 for further descriptions of these parameters.

**Table 7: Resetting and Silencing Alarms**

	ALARM LATCHING: LATCHING	ALARM LATCHING: SELF RESET
ALARM SILENCE: ON	(factory setting) <ul style="list-style-type: none"> <li>Press and release the RESET button to silence the buzzer.</li> <li>If the gas concentration was still above the alarm level when the button was pressed, the LED arrays continue to flash, the vibrator continues to pulse, and the GX-6000 continues to display the current alarm level.</li> <li>The gas reading must fall below (or rise above for an oxygen low alarm) an alarm setting before you can reset the alarm, the LEDs, and the vibrator using the RESET button.</li> </ul>	<ul style="list-style-type: none"> <li>Press and release the RESET button to silence the buzzer.</li> <li>The RESET button will not reset the alarm.</li> <li>Alarm, LEDs, and vibrator will automatically reset when gas reading falls below (or rises above for an oxygen low alarm) an alarm setpoint.</li> </ul>
ALARM SILENCE: OFF	<ul style="list-style-type: none"> <li>RESET button will not silence buzzer.</li> <li>The gas reading must fall below (or rise above for an oxygen low alarm) an alarm setting before you can reset the alarm condition using the RESET button.</li> </ul>	<ul style="list-style-type: none"> <li>RESET button will not silence or reset alarm.</li> <li>Alarm condition will automatically reset when gas reading falls below (or rises above for an oxygen low alarm) an alarm setpoint.</li> </ul>

### **Responding to Over Range Alarms**

**WARNING:** *An over range condition may indicate an extreme combustible gas, toxic gas, or oxygen concentration. Confirm a normal condition with a different GX-6000 or with another gas detecting device.*

**CAUTION:** *High off-scale readings may indicate an explosive concentration.*

**PRUDENCE:** *Des lectures élevées hors échelle peuvent indiquer une concentration explosive.*

- Determine which channel is in alarm.
- Follow your established procedure for an extreme gas condition.

---

**NOTE:** If your instrument has both a low range PID sensor and a high range PID sensor installed and if you are monitoring for gases in the higher range, the low range PID channel may be in over range alarm while monitoring, depending on the level of VOCs present.

---

- Reset the alarm using the RESET button once the alarm condition has cleared.

4. Calibrate the GX-6000 as described in “Chapter 4: Calibration Mode” on page 70.
5. If the over range condition continues or if you are not able to successfully calibrate the unit, you may need to replace the sensor that has triggered the over range alarm.
6. If the over range condition continues after you have replaced the sensor, contact RKI Instruments, Inc. for further instructions.

### **Responding to Battery Alarms**

**WARNING:** *The GX-6000 is not operational as a gas monitoring device during a dead battery alarm. Take the Model GX-6000 to a non-hazardous area and replace or recharge the batteries as described in “Replacing or Recharging the Batteries” on page 102.*

The GX-6000 is fully functional during a low battery warning. However, only a limited amount of operating time remains, approximately 1 - 2 hours. The amount of time depends on how often the LCD backlight is used and how often the unit is responding to alarm conditions. Recharge the Li-ion battery pack or replace the alkaline batteries as soon as possible as described in “Replacing or Recharging the Batteries” on page 102.

**NOTE:** Alarms and the LCD back light consume battery power and reduce the amount of operating time remaining.

### **Responding to Sensor Failure Alarms**

1. Determine which sensor has triggered the sensor failure alarm.
2. Try calibrating the failed sensor, as described in “Chapter 4: Calibration Mode” on page 70 before replacing it.
3. If the sensor failure continues, replace the sensor as described in “Replacing a Sensor” on page 116.
4. If the sensor failure condition continues after you have replaced the sensor, contact RKI Instruments, Inc. for further instructions.

### **Responding to Clock Failure Alarms**

A clock failure alarm occurs if the unit’s internal clock malfunctions.



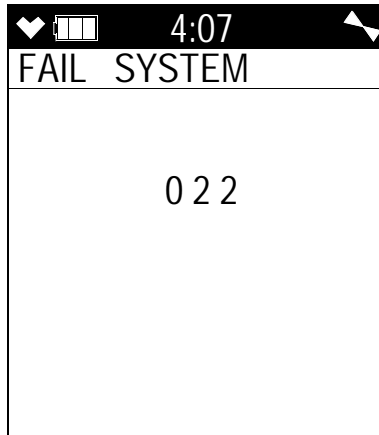
1. Press and release the RESET button to continue into Measuring Mode.

**CAUTION:** *There will be no datalogging function if you operate the instrument after a clock failure.*

2. Attempt to change the date using the **DATE** menu item in Maintenance Mode. See “Setting the Date and Time” on page 141.
3. If the date cannot be set correctly, contact RKI Instruments, Inc. as soon as possible.

### **Responding to System Failure Alarms**

1. If a system failure occurs, the system failure screen will display an error code as shown below:



2. The error code meanings are shown in the table below:

**Table 8: Error Code Explanation**

<b>Error Code</b>	<b>Explanation</b>
000	ROM failure
010	RAM failure
021	FRAM failure
022	FLASH memory failure

3. If the error code is anything but 022 as shown above, the instrument cannot be used. Contact RKI Instruments, Inc. as soon as possible.

If the error code is 022, you may press and release the RESET button to continue into Measuring Mode if the instrument must be used temporarily.

**CAUTION:** *There will be no datalogging function if you operate the instrument after a 022 system failure. Contact RKI Instruments, Inc. as soon as possible.*

### **Responding to a Man Down Warning 1 and Warning 2**

The Man Down Warning 1 and Warning 2 alarms occur after the **WARNING 1 TIME** and **WARNING 2 TIME**, respectively, has passed since the last movement of the instrument. See “Updating the WARNING 1 TIME Setting” on page 157 and “Updating the WARNING 2 TIME Setting” on page 157 for instructions to change these values.

1. Follow your established procedure for a man down warning.
2. To silence the alarm and reset the Man Down clock, move the instrument or press and release the RESET button.

### **Responding to a Man Down Alarm**

The Man Down Alarm alarms occur after the **ALARM TIME** has passed since the last movement of the instrument. See “Updating the ALARM TIME Setting” on page 157 for instructions to change this value.

1. Follow your established procedure for a man down alarm.
2. To silence the alarm and reset the Man Down clock, press and release the RESET button. Moving the instrument will not reset the alarm or Man Down clock.

### **Responding to a Panic Alarm**

If the user is in a dangerous situation or feels that others must be alerted to any sort of problem, holding the SHIFT ▼ (PANIC) button will initiate a panic alarm.

1. Press and release the RESET button to silence and reset the alarm.

---

## **Display Mode**

Two other operating modes are accessible when the GX-6000 is in Measuring Mode. They are Display Mode and Calibration Mode. This section describes using the GX-6000 in Display Mode. See Table 9 below for a list of Display Mode’s menu items, a short description of each item, and the page number for further description.

**Table 9: Display Mode Items**

<b>Menu Item (page number)</b>	<b>Description</b>
SELECT PID LIST (pg.49)	Define the PID channel’s gas name
PEAK (pg.51)	View and clear peak readings
STEL (pg.52)	View STEL readings ( <i>H<sub>2</sub>S</i> , <i>CO</i> , and high range PID only)
TWA (pg.52)	View TWA readings ( <i>H<sub>2</sub>S</i> , <i>CO</i> , and high range PID only)
ALARM POINTS (pg.53)	View the alarm points
OPERATION TIME (pg.55)	View the time in operation
DATE AND BATTERY (pg.55)	View the date/time, battery voltage, and battery type
LOG REMAIN (pg.56)	View the log time remaining
LOG CLEAR (pg.56)	Clear the log data
PUMP OFF (pg.58)	Turn the pump on or off (if the <b>PUMP OFF DISP</b> item in Maintenance Mode is set to <b>ON</b> )
USER ID (pg.59)	Select the user ID (if the <b>ID DISPLAY</b> item in Maintenance Mode is set to <b>ON</b> )
STATION ID (pg.60)	Select the station ID (if the <b>ID DISPLAY</b> item in Maintenance Mode is set to <b>ON</b> )
REC. DATA DISP (pg.62)	View snap logger data
PEAK BAR (pg.63)	Turn the peak bar function on or off
GAS DISP (pg.64)	Change how the gas readings are displayed

**Table 9: Display Mode Items**

<b>Menu Item (page number)</b>	<b>Description</b>
INVERT SELECT (pg.65)	Turn the LCD flip function on or off
CAT (LEL) SENSOR (pg.66)	Turn the combustible sensor protection on or off
LCD BACKGROUND (pg.67)	Reverse the black/white of the LCD
LANGUAGE (pg.67)	Change the instrument's language back to English (only appears if the language has been changed to something other than English)

### **Tips for Using Display Mode**

- To enter Display Mode and scroll from one menu item to the next or skip an item when a question is asked, press and release the DISP/LOCK button.
- To enter an item, press and release the POWER/ENTER button.
- To change a flashing parameter, use either the ▲AIR button or SHIFT ▼ (PANIC) button.
- To return to Measuring Mode from the top level of any menu item, press and release the RESET button.

---

**NOTE:** With the exception of the Pump Off Screen, each screen displays for 20 seconds. If you do not press a button within 20 seconds, the GX-6000 automatically returns to Measuring Mode. If the Pump Off Screen is used to turn the instrument's pump off, the Pump Off Screen will display until you turn the pump back on.

---

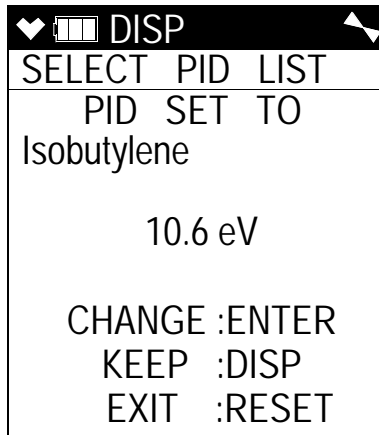


## PID Gas Name Screen

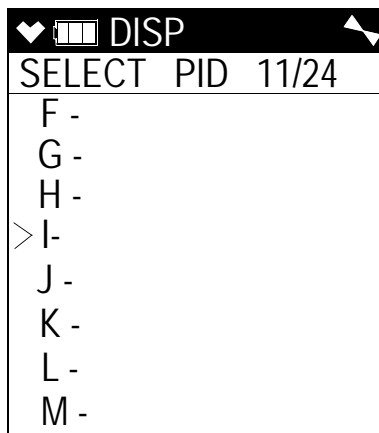
The standard PID channel is configured for and calibrated to isobutylene. If calibration to a different gas is required for an application, the PID channel can also be configured for other gases. Regardless of what gas the PID sensor is configured for and calibrated to, the sensor will still detect and respond to a variety of volatile organic compounds (VOCs).

If you configure the instrument for another gas, the instrument will retain that configuration until you change it again. Turning the instrument off and on does not change this setting.

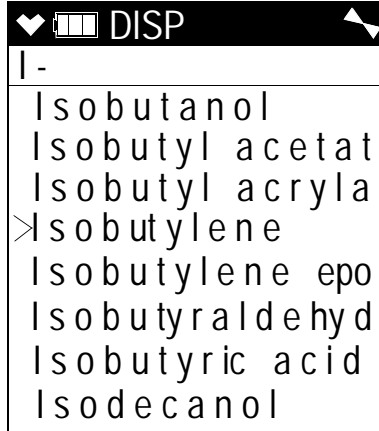
If there are 2 PID sensors installed in your GX-6000, the PID Gas Name Screens will appear in Display Mode in the following order regardless of their position in the flow system: 10.0 eV/benzene, 10.6 eV, 11.7 eV.



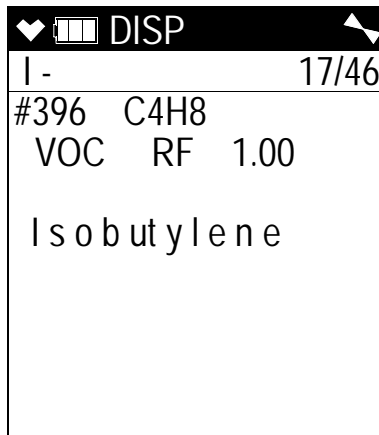
1. With the PID Gas Name Screen displayed, press and release the POWER/ENTER button. The top level of the PID Gas Name List will be displayed and the cursor will be next to the letter corresponding to the first letter of the current setting. In the example below, the PID channel is configured for isobutylene so the cursor is next to "I". Each letter has a list of gas names behind it. At the top of the letter list, there is a User List item and a Recent List item. The User List can hold 30 gas names and the GX-6000 PID Gas List Editor Program is required to configure this list. The Recent List can hold up to 8 gas names and is made up of the 8 most recently used gas names. The Recent List is not user editable.



- Use the ▲AIR and SHIFT ▼(PANIC) buttons to scroll through the letter and list options. To view the gas names behind a letter, User List, or Recent List, press and release the POWER/ENTER button when the cursor is next to the desired letter.



- Use the ▲AIR and SHIFT ▼(PANIC) buttons to scroll through the gas names.
- To view the information for each gas name, press and release the POWER/ENTER button when the cursor is next to the desired gas name. The number in the upper left corner is the gas's number in relation to all other gas names that are stored in the GX-6000. The chemical formula is displayed next to the gas number. The response factor relative to isobutylene is listed on the second line. The gas name is listed on the third line.

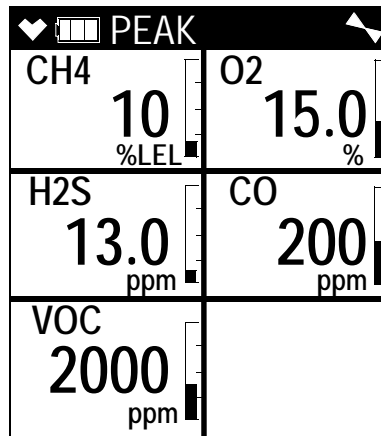


- To select a gas name, press and release the POWER/ENTER button while you are viewing the parameters. The selection will be in effect until you change it again. To return to the gas name list without saving any changes, press and release the DISP/LOCK button.
- To return to the top level PID Gas Name List that has all of the letter choices, press and release the DISP/LOCK button.
- To return to the PID Gas Name Screen, press and release the DISP/LOCK button one more time.

## Peak Screen

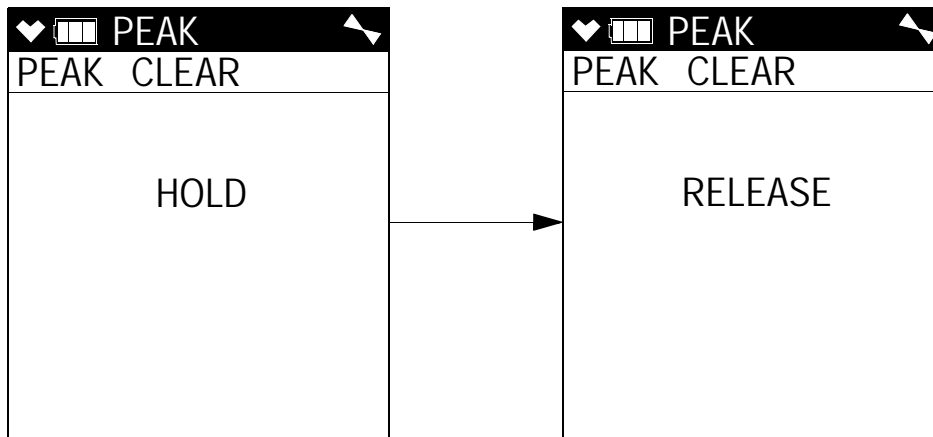
The peak screen displays the highest (lowest for oxygen) concentrations detected since the GX-6000 was turned on. Peak readings are stored in the GX-6000's memory until a higher level is detected (lower for oxygen), the peak reading is cleared, or the GX-6000 is turned off.

The lunch break feature enables the GX-6000 to save peak readings when it is turned off so it can continue them when it is turned on again. See "Turning On the GX-6000" on page 25.



To clear the peak readings, do the following:

1. With the Peak Screen displayed, press and hold the RESET button. The following screen sequence will occur.

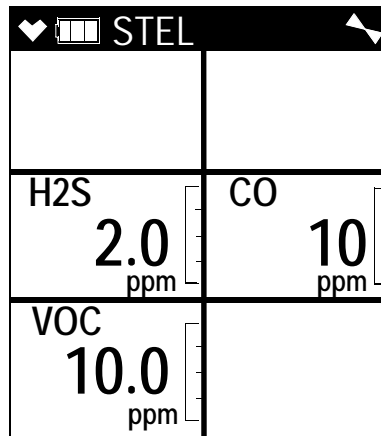


2. Release the RESET button. The peak readings will be reset and the unit will return to the Peak Screen.

If you do not want to clear the peak readings, release the RESET button before the above screen sequence occurs. The unit will return to the Peak Screen.

## STEL Screen

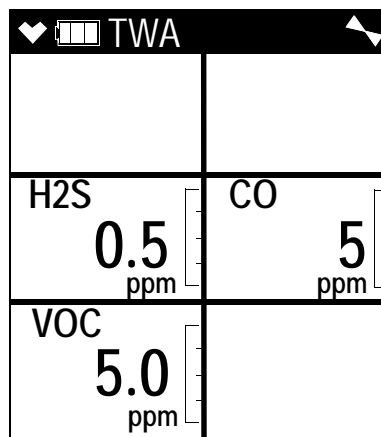
The STEL Screen displays the short term exposure limit (STEL) readings *for H<sub>2</sub>S, CO, and high range VOC only*. The STEL reading is the average reading *over the last 15 minutes*.



STEL	
H <sub>2</sub> S 2.0 ppm	CO 10 ppm
VOC 10.0 ppm	

## TWA Screen

The TWA Screen displays the time weighted average (TWA) readings *for H<sub>2</sub>S, CO, and high range VOC only*.



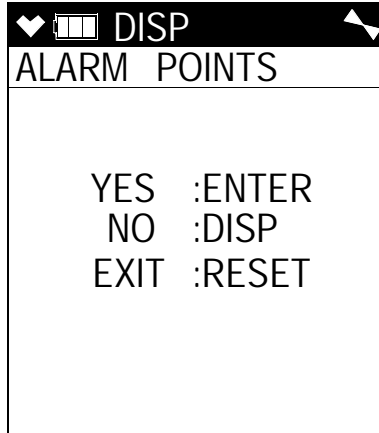
TWA	
H <sub>2</sub> S 0.5 ppm	CO 5 ppm
VOC 5.0 ppm	

The TWA reading is the average reading *over the last 8 hours*. If 8 hours have not elapsed since the last time the TWA reading was cleared, the average is still calculated over 8 hours. The missing time is assigned a 0 value for readings. If **LUNCH BREAK** is set to **OFF**, the TWA is cleared when the GX-6000 is turned off.

If **LUNCH BREAK** is set to **ON**, the GX-6000 will remember TWA readings when it is turned off so it can continue them when it is turned on again. See “Turning On the GX-6000” on page 25.

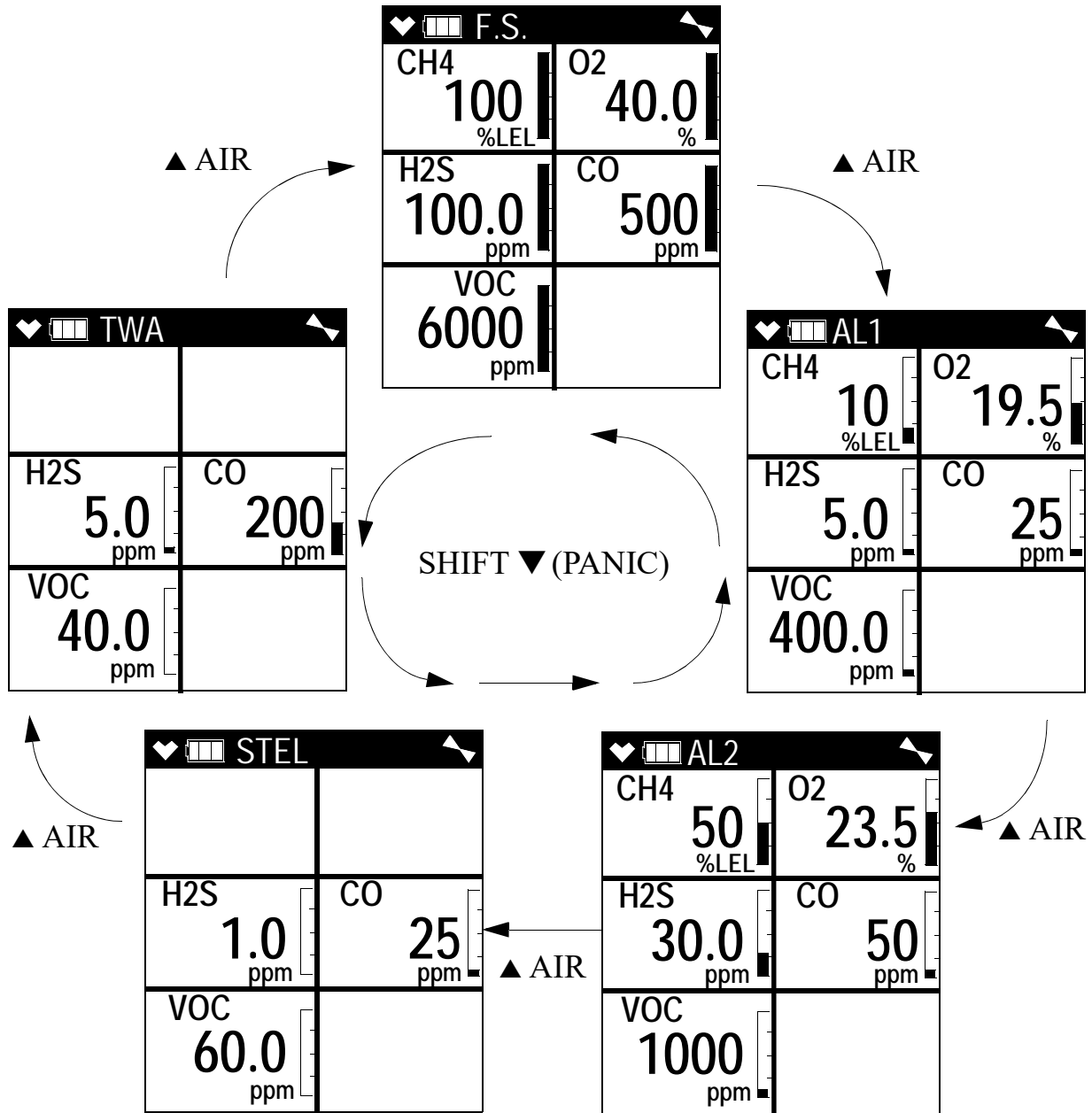
## View Alarm Settings Screen

The View Alarm Settings Screen gives you the option to view the gas alarm settings for all active channels.



To view the gas alarm settings, do the following:

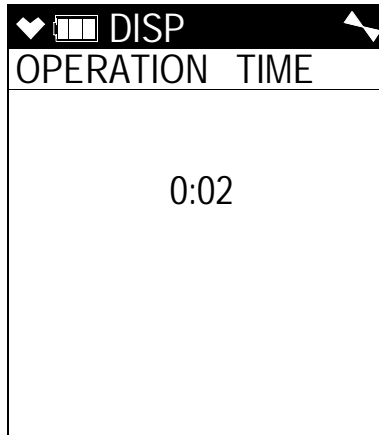
- 1 . With the View Alarm Settings Screen displayed, press and release the POWER/ENTER button. The Full Scale Settings screen will appear showing full scale settings for each channel. Use the ▲AIR and SHIFT ▼(PANIC) buttons to scroll through the Warning, Alarm, STEL, and TWA settings.



2. Pressing and releasing the POWER/ENTER button while in a settings screen will cause the instrument to simulate that condition. The buzzer, LED's, and vibration will activate. Press and release the POWER/ENTER button again to stop the simulated alarm.
3. Press and release the DISP/LOCK button to return to the View Alarm Settings Screen.

## Time in Operation Screen

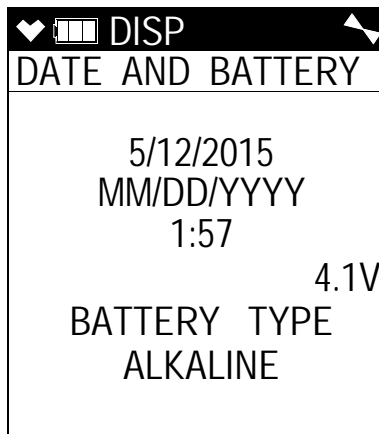
The Time In Operation Screen displays the length of time since the GX-6000 was turned on if the lunch break feature is turned off. With **LUNCH BREAK** set to **OFF**, the time in operation is reset when the GX-6000 is turned off. See “Updating the Lunch Break Setting” on page 152 for a description of the lunch break feature.



If **LUNCH BREAK** is set to **ON**, the time in operation will only be reset if you do not choose to resume the peak and TWA measurements when the GX-6000 is turned on in the Lunch Break Screen described in Step 3 on page 26 in “Turning On the GX-6000”. If you choose to resume the peak and TWA measurements during startup, the GX-6000 will include the time in operation when the unit was last turned off in the current time in operation.

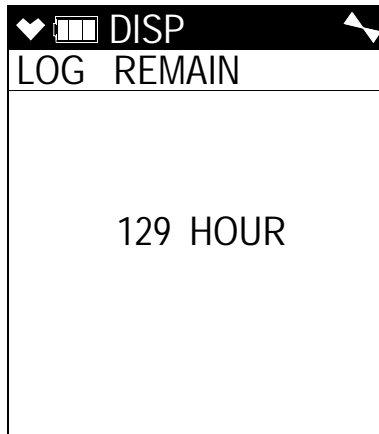
## Date/Time, Battery Voltage Screen

The Battery Voltage Screen displays the current battery voltage. Fully charged alkaline batteries typically indicate around 6.0 volts; a fully charged Li-ion battery pack typically indicate 4.1 volts. This screen also displays during the startup sequence.



## Log Time Remaining Screen

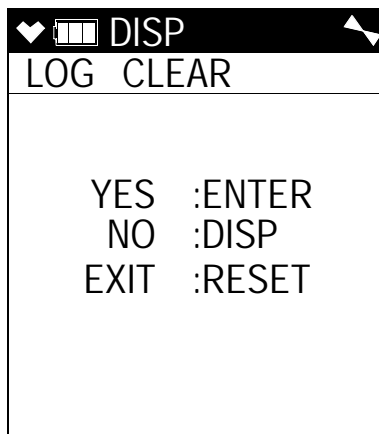
The Data Logging screen displays the time remaining until the data logger memory is full.



## LOG CLEAR Screen

**CAUTION:** *Once you clear the data logger, you cannot retrieve any data previously stored in the data logger.*

The **LOG CLEAR** screen asks if you want to clear the data logger memory.

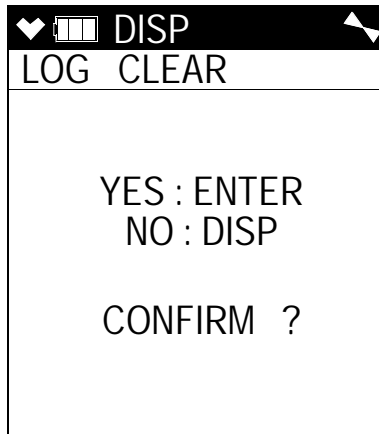


To continue through Display Mode without clearing the log data, press and release the DISP/LOCK button.

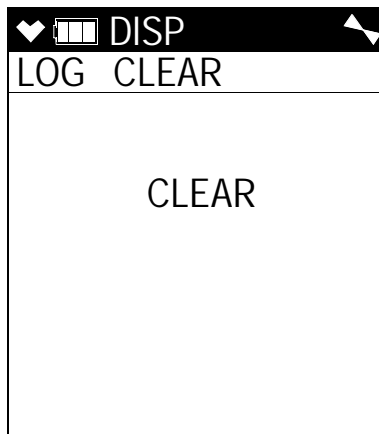


To clear the data logger memory, do the following:

- 1 . With the **LOG CLEAR** Screen displayed, press and release the POWER/ENTER button. The following screen appears asking you to confirm that you want to clear the data logger memory.



- 2 . If you do not want to clear the data logger memory, press and release the DISP/LOCK button. The unit will return to the **LOG CLEAR** screen in Display Mode.
- 3 . If you want to clear the data logger memory, press and release the POWER/ENTER button. The unit will display the following screen as it clears the data.



- 4 . When the instrument has cleared the data, it will return to the **LOG CLEAR** screen in Display Mode.

## Pump Off Screen

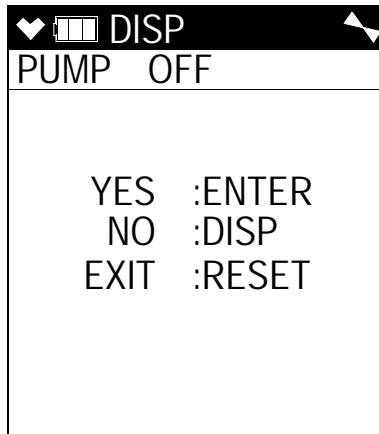
**WARNING:** *The GX-6000 is not a gas monitoring device while the pump is off.*

---

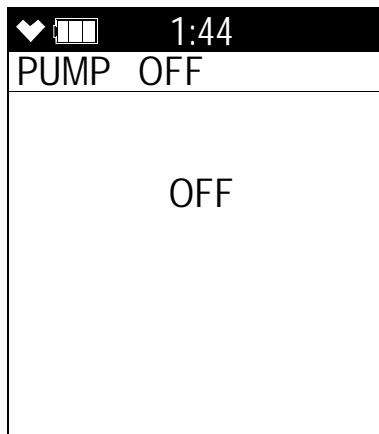
**NOTE:** The item appears in Display Mode only if the **PUMP OFF DISP** menu item in Maintenance Mode is turned **ON**. The factory setting for **PUMP OFF DISP** is **OFF**.

---

This feature can be used to conserve battery life if there is a significant period of time until the next gas monitoring task, but you do not want to wait for the warm-up sequence to complete if you turn the instrument off and on again.



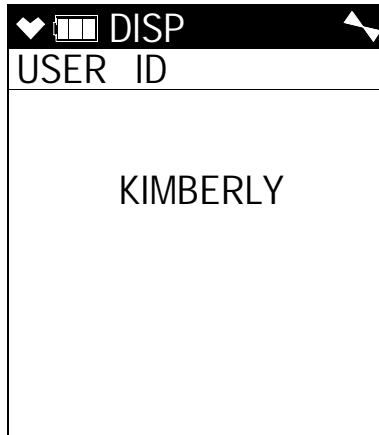
- 1 . In this screen, press and release the POWER/ENTER button to turn the pump off. The fan symbol in the upper right corner will disappear. Once the pump is off, you cannot exit this screen and return to Measuring Mode or continue in Display Mode until you turn the pump back on.



- 2 . To turn the pump back on and continue in Display Mode or return to Measuring Mode, press and release the DISP/LOCK button.

## Select User ID Screen

This screen only appears in Display Mode if the **ID DISPLAY** item in Maintenance Mode is set to **ON**. Use this screen to select a user ID from the user ID list in the GX-6000's memory. The current user ID is displayed. A user ID can be up to 16 characters long. The GX-6000 can store up to 128 user IDs.

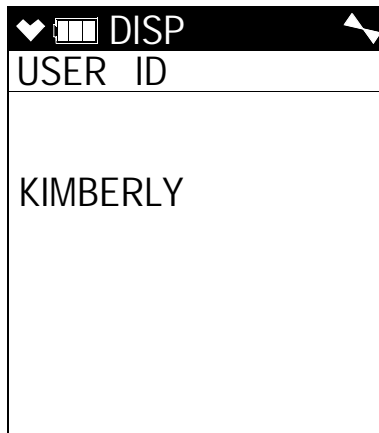


The user ID provides a way to identify the GX-6000 user during a data logging session. If the user ID is changed during an operating session, a new data session is initiated with the new user ID attached to it. This allows you to change the user ID during operation and have each user ID that was used during an operating session saved for the corresponding data. See the GX-6000 Data Logger Management Program Operator's Manual for a detailed description of data logging and the user ID.

The user ID list cannot be edited using the GX-6000 user interface. The GX-6000 Maintenance Data Loader Program is required to define or change user IDs in the user ID list. For a detailed description of editing the list of user IDs stored in the GX-6000, see the GX-6000 Maintenance Data Loader Program Operator's Manual.

To select a different user ID:

1. With the Select User ID Screen displayed, press and release the POWER/ENTER button. The current user ID will be displayed and it will be flashing.



2. Use the ▲AIR and SHIFT ▼(PANIC) buttons to scroll through the available user IDs. The list will wrap around if you get to the top or bottom. Any of the user IDs in the list that have not been changed from the factory setting will be shown as USER\_ID\_XXX where the "XXX" is a number from 001 to 128.

3. When the desired user ID is displayed, press and release the POWER/ENTER button.

---

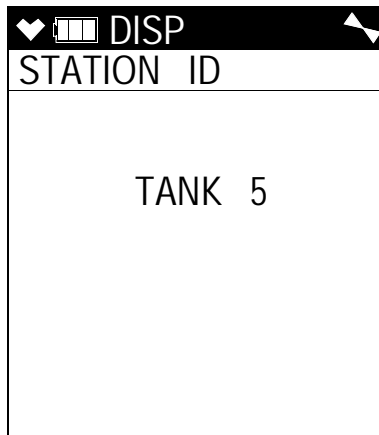
**NOTE:** To exit the selection screen without saving a change, press and release the DISP/LOCK button. You will return to the Select User ID screen without saving the user ID change.

---

4. The unit will save the selected user ID as the current one and will return you to the Select User ID Screen.

### Select Station ID Screen

This screen only appears in Display Mode if the **ID DISPLAY** item in Maintenance Mode is set to **ON**. Use this screen to select a station ID from the station ID list in the GX-6000's memory. The current station ID is displayed. A station ID can be up to 16 characters long. The GX-6000 can store up to 128 station IDs.

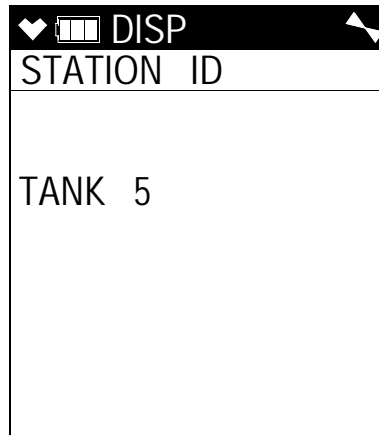


The station ID provides a way to identify a location where monitoring was done during a data logging session. If the station ID is changed during an operating session, a new data session is initiated with the new station ID attached to it. This allows you to change the station ID during operation and have each station ID that was used during an operating session saved for the corresponding data. See the GX-6000 Data Logger Management Program Operator's Manual for a detailed description of data logging and the station ID.

The station ID list cannot be edited using the GX-6000 user interface. The GX-6000 Maintenance Data Loader Program is required to define or change station IDs in the station ID list. For a detailed description of editing the list of station IDs stored in the GX-6000, see the GX-6000 Maintenance Data Loader Program Operator's Manual.

To select a different station ID:

- 1 . With the Select Station ID Screen displayed, press and release the POWER/ENTER button. The current user ID will be displayed and it will be flashing.



- 2 . Use the ▲AIR and SHIFT ▼(PANIC) buttons to scroll through the available station IDs. The list will wrap around if you get to the top or bottom. Any of the station IDs in the list that have not been changed from the factory setting will be shown as STATION\_ID\_XXX where the “XXX” is a number from 001 to 128.
- 3 . When the desired station ID is displayed, press and release the POWER ENTER button.

---

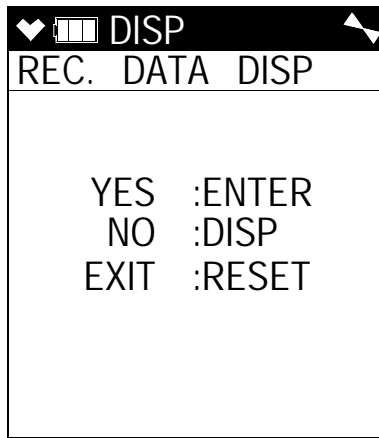
**NOTE:** To exit the selection screen without saving a change, press and release the DISP/LOCK button. You will return to the Select Station ID screen without saving the station ID change.

---

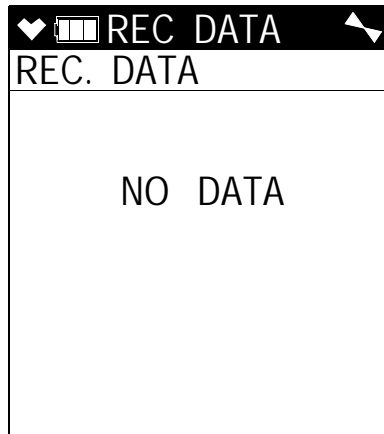
- 4 . The unit will save the selected station ID as the current one and return you to the Select Station ID Screen.

## Viewing Snap Logger Data

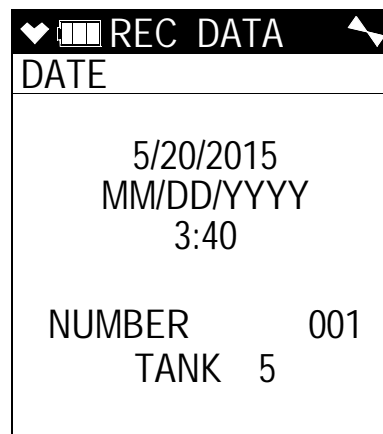
The Snap Logging Screen allows you to view data from previous snap logs. For information on how to use the snap logging feature, see “Snap Log Mode” on page 39.



1. With the snap logging screen displayed, press and release the POWER/ENTER button. The screen that appears will depend on whether or not any snap logs have been taken.



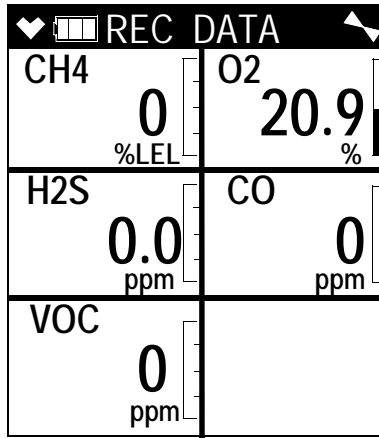
No snap logs taken



Snap logs taken

2. If snap logs have been taken, the screen indicates the year, month, day, and time that the most recent snap log was taken.  
The number near the bottom of the screen indicates the snap log ID number. The first snap log that is taken is given an ID of 001. The next snap log ID is 002. The ID number increases sequentially with each set of snap log data.  
The last line of the screen indicates the Station ID that was used for the snap log.
3. Use the ▲AIR and SHIFT ▼(PANIC) buttons to scroll through different snap log IDs.

- To view the data in a snap log ID, press and release the POWER/ENTER button.

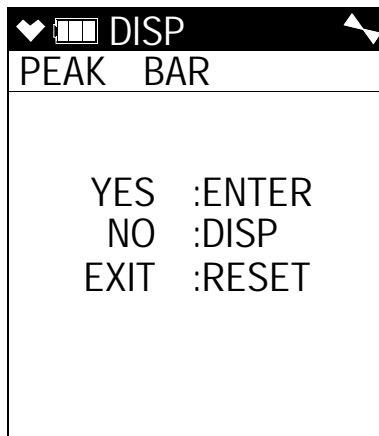


The gas readings that were taken during the snap log are displayed. You can use the ▲AIR and SHIFT ▼ (PANIC) buttons to scroll through the different snap logs. The gas readings will change as you view different snap log data but the snap log ID is not visible from this screen. To scroll through the data by viewing the snap log ID number, press and release POWER/ENTER.

- To return to the Snap Logging Screen, press and release the DISP/LOCK button.

### Peak Bar Screen

The Peak Bar Screen allows you to turn the peak bar on or off. If the function is turned on, the peak bar appears along the right side of each gas reading in Measuring Mode and on the Peak Screen in Display Mode. It shows the peak readings for each channel in bar graph format.

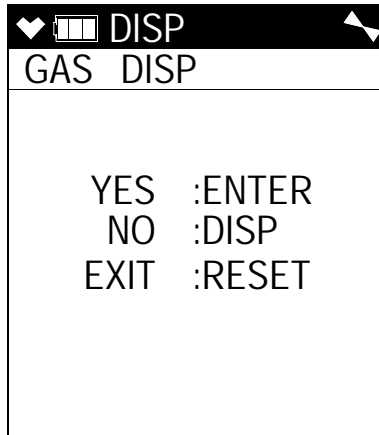


- With the Peak Bar Screen displayed, press and release the POWER/ENTER button. The current setting will be displayed.
- Use the ▲AIR and SHIFT ▼ (PANIC) buttons to display the desired setting.
- Press and release the POWER/ENTER button to save the setting and return to the Peak Bar Screen.

To return to the Peak Bar Screen without saving any changes, press and release the DISP/LOCK button.

## Gas Display Screen

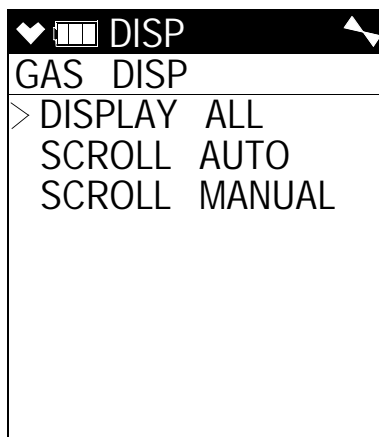
The Gas Display Screen allows the user to choose how the gas readings are displayed in Measuring Mode. A description of the choices can be found in Table 10 below. If anything other than **DISPLAY ALL** is selected, the instrument will return to **DISPLAY ALL** when it is turned off and turned back on.



**Table 10: Gas Display Choices**

Option	Description
DISPLAY ALL	All active channels' readings will be displayed at once
SCROLL AUTO	One active channel will display at a time and the instrument will automatically scroll through all active channels for the duration of the operating session.
SCROLL MANUAL	One active channel will display at a time and the user must press and release the POWER/ENTER button to scroll through all active channels. If the POWER/ENTER button is not pressed and released, the instrument will display the same channel's readings for the duration of the operating session.

- 1 . With the Gas Display Screen showing, press and release the POWER/ENTER button. The available choices will appear.



- 2 . Use the ▲AIR and SHIFT ▼ (PANIC) buttons to move the cursor next to the desired setting.



3. Press and release the POWER/ENTER button to return to the Gas Display Screen.  
To return to the Gas Display Screen without saving any changes, press and release the DISP/LOCK button.

## LCD Flip Screen

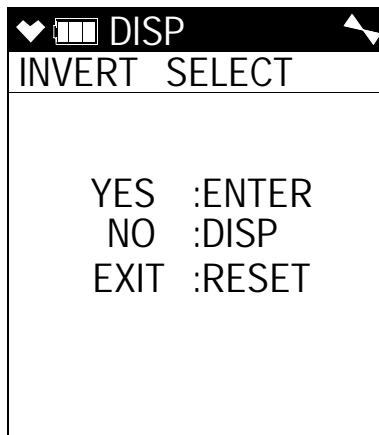
If **INVERT SELECT** is set to **ON**, the instrument's LCD will automatically flip if the instrument is turned upside down. This allows for the LCD to be read with the instrument right side up or upside down. If desired, holding down the DISP/LOCK button will lock the screen in its current position and keep it from rotating. A **LOCK** symbol will flash at the top of the screen to indicate that the LCD's position is fixed. To unlock the LCD, hold the DISP/LOCK button until the **LOCK** symbol disappears.

---

**NOTE:** Even if **INVERT SELECT** is set to **ON**, the screens in Calibration Mode, User Mode, and Maintenance Mode will not flip if the instrument is turned upside down.

---

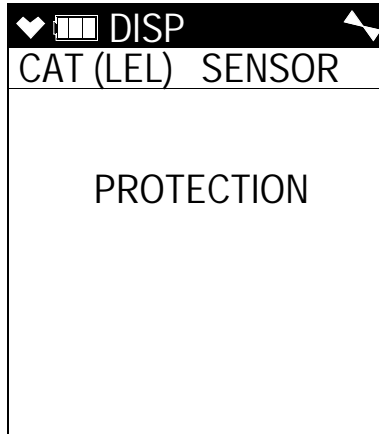
If **INVERT SELECT** is set to **OFF**, the instrument's LCD will not flip and can only be read when the instrument is right side up. A **LOCK** symbol will appear at the top of the screen to indicate that the LCD's position is fixed.



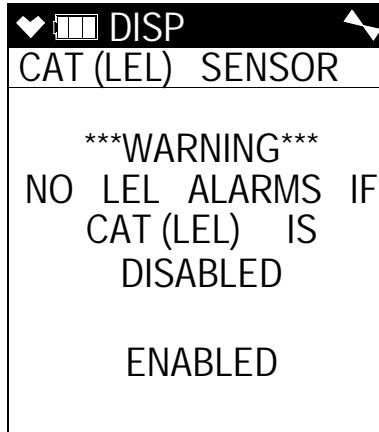
1. With the Gas Display Screen showing, press and release the POWER/ENTER button. The current setting will be displayed.
2. Use the ▲AIR and SHIFT ▼(PANIC) buttons to display the desired setting.
3. Press and release the POWER/ENTER button to return to the LCD Flip Screen.  
To return to the LCD Flip Screen without saving any changes, press and release the DISP/LOCK button.

## Combustible Sensor Protection Screen

If combustible gas levels greater than 100 %LEL are expected, the catalytic LEL sensor can be disabled to protect it. If the catalytic LEL sensor is disabled, there will be no %LEL alarms in Measuring Mode.



1. With the **CAT (LEL) SENSOR PROTECTION** screen displayed, press and release the POWER/ENTER button. The current setting will be displayed along with a warning about no %LEL alarms if the catalytic LEL sensor is turned off.



2. Use the ▲AIR or SHIFT ▼(PANIC) button to display the desired setting.

---

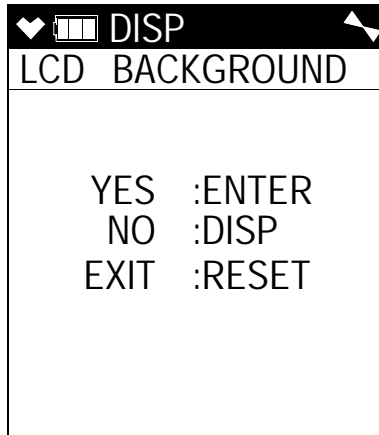
**NOTE:** If the catalytic LEL sensor is disabled and if the instrument is then turned off and back on, the catalytic LEL sensor will be enabled again.

---

3. Press and release the POWER/ENTER button to return to the **CAT (LEL) SENSOR PROTECTION** screen in Display Mode.

## LCD Background Color Flip

With **LCD BACKGROUND** set to **ON**, the LCD colors will flip. The background will be black instead of white and the text will be white instead of black. With **LCD BACKGROUND** set to **OFF** (factory setting), the LCD background will be white and the LCD text will be black.

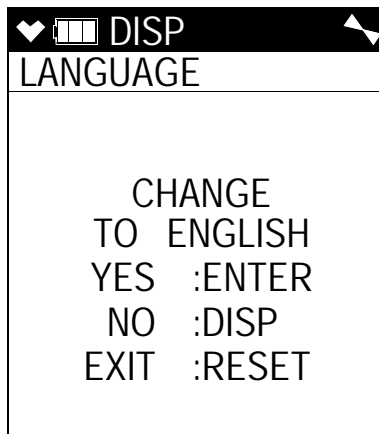


1. With the LCD Background Flip Screen showing, press and release the POWER/ENTER button. The current setting will be displayed.
2. Use the ▲AIR and SHIFT ▼(PANIC) buttons to display the desired setting.
3. Press and release the POWER/ENTER button to return to the LCD Background Flip Screen.

To return to the LCD Background Flip Screen without saving any changes, press and release the DISP/LOCK button.

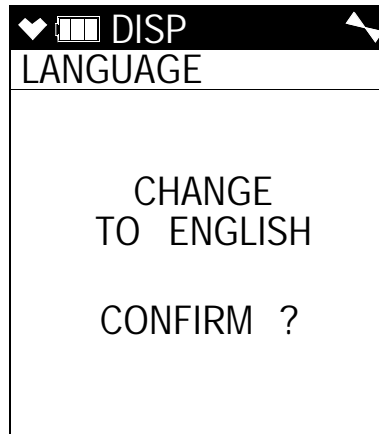
## Language Screen

If the instrument's language is changed to something other than English, the Language Screen will appear in Display Mode. The Language Screen will not appear if the instrument's language is set to English. The Language Screen allows the user to change the instrument's language back to English.



To change the language back to English, do the following:

1. With the Language Screen showing, press and release the POWER/ENTER button. The following screen will appear asking you to confirm that you want to change the language back to English.



2. Press and release the POWER/ENTER button again to confirm the change. To return to the Language Screen without changing the instrument's language to English, press and release the DISP/LOCK button.

---

## Data Logging

---

**NOTE:** The GX-6000 only logs data while in Normal Mode. If the GX-6000 is used in Leak Check Mode or Bar Hole Mode, no downloadable data will be logged while it is in either of these two modes.

---

The GX-6000 features the ability to log data to its internal memory and download it to a computer via the infrared communications port on the front of the unit. It logs gas readings in Measuring Mode, alarm data, and calibration data.

---

**NOTE:** The data logging function is separate from the snap logging function. For a description of the snap logging function, see “Snap Log Mode” on page 39.

---

To utilize the GX-6000's downloading capability, you will need the GX-6000 Data Logger Management Program and a computer with an infrared port or a USB port that runs one of the following operating systems: Windows 7, Windows 8, or Windows 10. If your computer has an infrared port, then no additional accessories are needed to download data from the GX-6000. If your computer does not have an infrared port but does have a USB port, a USB/IrDA adapter cable can be used to download data from the GX-6000 using the USB port. The GX-6000 Data Logger Management Program is available at [www.rkiinstruments.com/gx6000](http://www.rkiinstruments.com/gx6000). The USB/IrDA adapter cable is available from RKI Instruments, Inc.

The data logging capacity depends on how often the GX-6000 stores data, how many channels are active, and how often the GX-6000 is turned on and off. The table below illustrates how much data logging time is available for the various interval times. It assumes that the unit is a standard four sensors plus PID unit, is only turned on once, and there are no alarm occurrences. See “Updating the Data Log Interval Setting” on page 158 for instructions on setting the data logging interval time.

**Table 11: Data Logging Capacity**

<b>Interval Time</b>	<b>Data Logging Time</b>
10 seconds	10 hours
20 seconds	20 hours
30 seconds	30 hours
1 minute	60 hours
3 minutes	180 hours
5 minutes	300 hours
10 minutes	600 hours

For a complete description of the Data Logger Management Program and procedures for downloading data to a computer, see the GX-6000 Data Logger Management Program Operator's Manual.

# Chapter 4: Calibration Mode

---

## Overview

This section describes the GX-6000 in Calibration Mode. In Calibration Mode, you can move through a menu of screens to do the following:

- Perform a fresh air (zero) adjustment
- Perform a span adjustment on all channels simultaneously using auto calibration
- Perform a span adjustment on one channel at a time using single calibration
- Perform a bump test

---

**NOTE:** You can set up the GX-6000 to alert you during the startup sequence when calibration is due. See “Updating the Calibration Reminder Setting” on page 142.

---

**CAUTION:** *BEFORE EACH DAY’S USAGE, SENSITIVITY IN THE %LEL RANGE MUST BE TESTED ON A KNOWN CONCENTRATION OF THE COMBUSTIBLE TARGET GAS, METHANE, EQUIVALENT TO 25 - 50% OF FULL SCALE CONCENTRATION (the %LEL full scale is 100 %LEL). ACCURACY MUST BE WITHIN -0 to + 20% OF ACTUAL. ACCURACY MAY BE CORRECTED BY FOLLOWING THE CALIBRATION INSTRUCTIONS FOR THE COMBUSTIBLE CHANNEL BELOW.*

If the combustible channel passes the above response test and does not require calibration, the unit should still be calibrated periodically. The optimum frequency of calibration depends heavily on how the GX-6000 is used. For example, instruments used daily may need to be calibrated weekly or monthly, while instruments that are used only a few times a year may need to be calibrated before each use. Typical calibration frequencies range from monthly to quarterly. Make sure to perform the combustible channel response test as described above and make sure to develop a calibration schedule tailored to your application that takes this test and required calibration resulting from this test into account.

---

## Calibration Supplies and Equipment

To calibrate the GX-6000, you will need:

- Known calibrating samples of the gases being detected. The combustible and toxic gas samples should have concentrations between 10 and 50% of the full scale value. For example, if you are calibrating the catalytic combustible gas channel, your calibration cylinder should have a combustible gas concentration between 10% LEL and 50% LEL. An oxygen-free source, such as 100% nitrogen is recommended for setting the oxygen zero.

**CAUTION:** *When using auto calibration, although the GX-6000 can be calibrated with an oxygen concentration of up to 19.5%, RKI Instruments, Inc. recommends that the multi-gas cylinder have an oxygen concentration in the range of 10% - 16% oxygen.*

- A demand-flow regulator to provide adequate sample gas flow

---

**NOTE:** RKI Instruments, Inc. recommends that you dedicate a regulator for use with chlorine (Cl<sub>2</sub>) gas and that you do not use that dedicated regulator for any other gases, particularly hydrogen sulfide (H<sub>2</sub>S).

---

- Non-absorbent tubing

**WARNING:** *If you are using a calibration kit that includes a gas bag and a fixed flow regulator or dispensing valve, do not apply gas directly to the GX-6000 with the regulator or dispensing valve or damage to the pump will result.*

To calibrate the %LEL, oxygen, CO, H<sub>2</sub>S, and PID sensors at the same time, automatically, with no need for a zero-oxygen source, you can use the auto calibration feature with either a 5-gas cylinder or a 4-gas cylinder and a PID cylinder. This chapter includes instructions for both scenarios along with instructions for calibrating one channel at a time using single calibration.

---

## Entering Calibration Mode

To enter Calibration Mode, do the following:

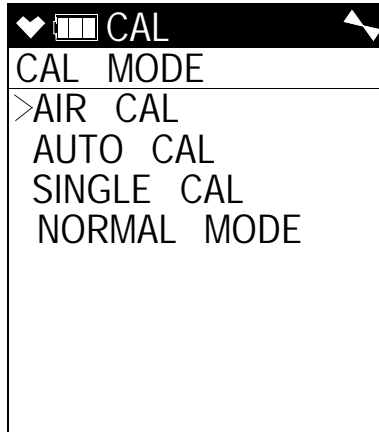
1. Find a fresh-air environment. This is an environment free of toxic or combustible gases and of normal oxygen content (20.9%).
2. While in Measuring Mode, press and hold the SHIFT ▼ (PANIC) button, then press the DISP/LOCK button and release both buttons.
3. If the unit prompts you for the password, enter it by using the ▲AIR and SHIFT ▼ (PANIC) buttons to select each password number and then pressing and releasing POWER/ENTER to enter the number and move on to the next one.

---

**NOTE:** You will only be prompted to enter a password if the **PASSWORD** menu item in User Mode is set to **ON**. See “Turning the Password Function On or Off” on page 98 for instructions to update the **PASSWORD** setting and to choose a password.

---

4. The Calibration Mode Screen displays with the cursor next to **AIR CAL**.



---

**NOTE:** The following screens illustrate a five-gas GX-6000 for detection of CH<sub>4</sub> (%LEL using catalytic sensor), oxygen, H<sub>2</sub>S, CO, and VOCs (high range PID sensor). Your GX-6000 may display slightly different screens.

---

## Calibrating Using the Auto Calibration Method

This method allows you to calibrate the CH<sub>4</sub> (%LEL sensor), oxygen, H<sub>2</sub>S, CO, and VOC (PID sensor) sensors simultaneously. It is designed for use with either the RKI 5-gas calibration cylinder (high range PID only) or an RKI 4-gas cylinder and an RKI PID cylinder and is the quickest and easiest method to calibrate the GX-6000. See Table 16 on page 131 for available cylinders. Make sure your calibration cylinder is appropriate for the PID detection range.

---

**NOTE:** The 5-gas calibration cylinder that includes LEL CH<sub>4</sub>/O<sub>2</sub>/CO/H<sub>2</sub>S/isobutylene is a proprietary gas mix developed by RKI Instruments, Inc. for calibrating a PID sensor in the presence of the other gases during an auto calibration. It can also be used for a single calibration of a PID sensor. Do not use a similar gas mix provided by any other manufacturer when calibrating a PID channel. Use of a gas mix from another manufacturer that includes isobutylene and these other gases will result in an inaccurate calibration.

---

### Setting the Fresh Air Reading

1. Find a fresh-air environment. This is an environment free of toxic or combustible gases and of normal oxygen content (20.9%).
2. While in Measuring Mode, press and hold the SHIFT ▼ (PANIC) button, then press the DISP/LOCK button and release both buttons.



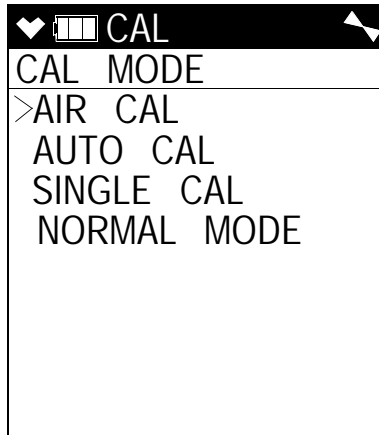
3. If the unit prompts you for the password, enter it by using the ▲AIR and SHIFT ▼ (PANIC) buttons to select each password number and then pressing and releasing POWER/ENTER to enter the number and move on to the next one.

---

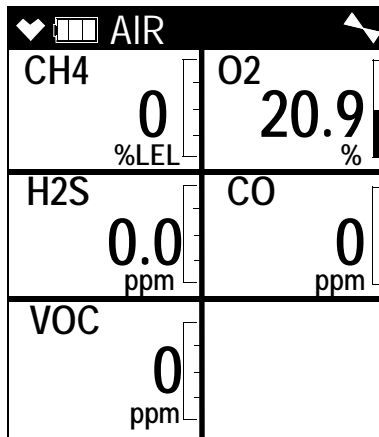
**NOTE:** You will only be prompted to enter a password if the **PASSWORD** menu item in User Mode is set to **ON**. See “Turning the Password Function On or Off” on page 98 for instructions to update the **PASSWORD** setting and to choose a password.

---

4. The Calibration Mode Screen displays with the cursor next to **AIR CAL**.



5. Press and release the POWER/ENTER button. The Fresh Air Reading screen will display.



6. If you suspect any low-level VOC background in the area, you will need to use the VOC zero filter.

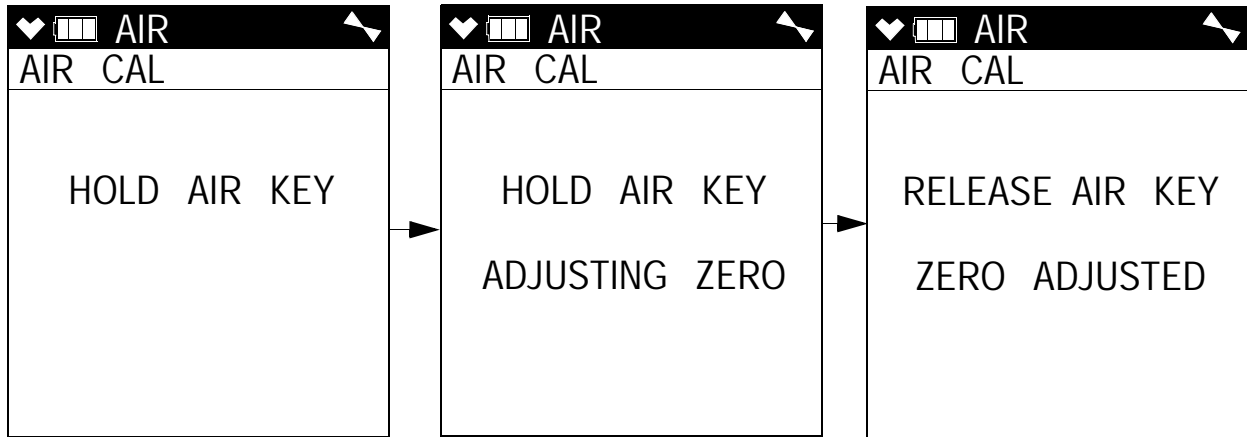
---

**NOTE:** If you have both a PID and a CO<sub>2</sub> sensor installed, you will need to follow the directions in “Performing a Demand Zero for Instruments with a Carbon Dioxide Sensor and a PID Sensor” on page 184 instead of following the directions shown below.

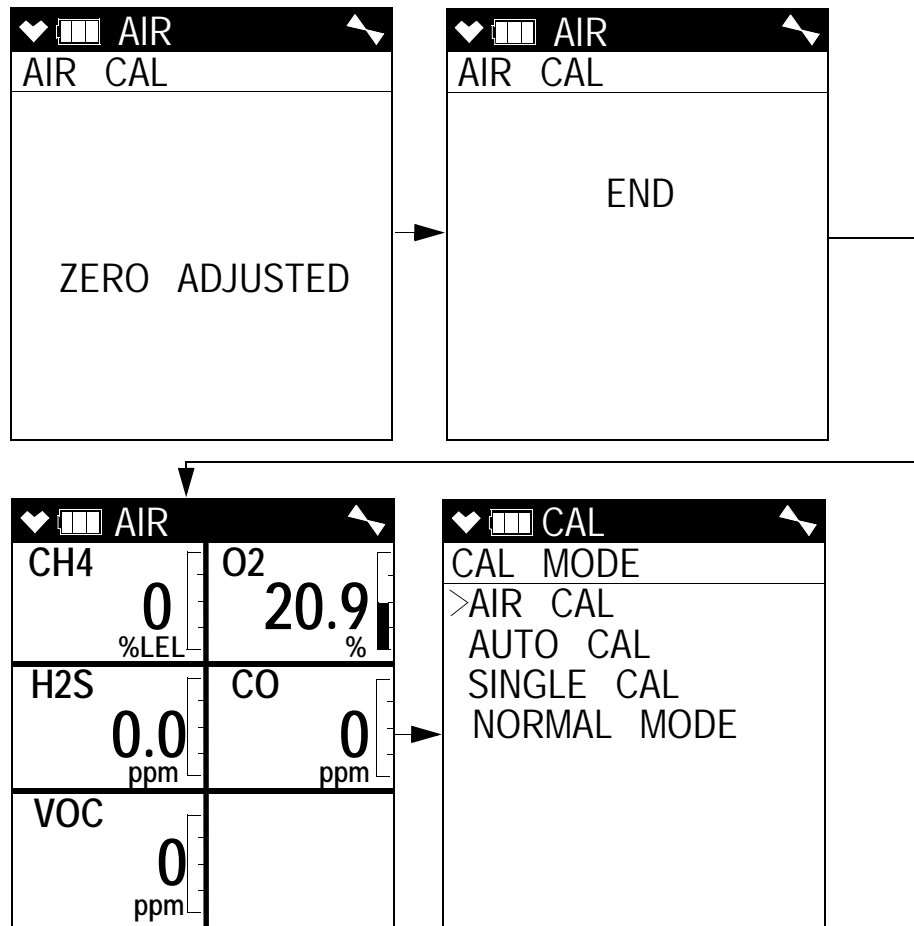
---

- a. Remove the plug from each end of the VOC zero filter.
- b. Attach the VOC zero filter to the inlet fitting or probe. The filter does not have a preferred flow direction.
- c. Let the instrument draw through the VOC zero filter for 1 minute before continuing.

7. To continue with the fresh air adjustment, press and hold the ▲AIR button.  
If you do not want to continue, press and release the DISP/LOCK button and the unit will return to the Calibration Mode Screen.
8. The GX-6000 will indicate that it is adjusting the zero reading for a few seconds and then it will prompt you to release the ▲AIR button.



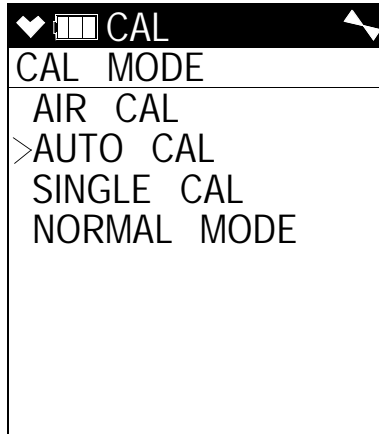
9. Release the ▲AIR button. The fresh air adjustment will finish, the fresh air readings will be displayed momentarily, and then the instrument will return to the Calibration Mode Screen.



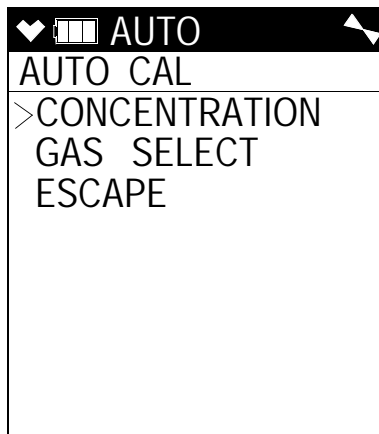
10. If the VOC zero filter was used, remove the filter from the GX-6000's inlet fitting or probe. Reinstall the plugs on each end of the filter.

## Performing a Span Adjustment

1. Install the demand flow regulator onto the 4-gas or 5-gas calibration cylinder.
2. Connect the sample tubing to the demand flow regulator.
3. Install the sample hose and probe on the GX-6000 inlet fitting. Make sure the probe's two halves are tightened firmly together to avoid leaks that can affect the calibration. See Figure 22, "Replacing the Particle Filter and Hydrophobic Filter Disk" on page 112 for an illustration of the internal parts of the probe.
4. Move the cursor next to the **AUTO CAL** menu item by using the **▲AIR** or **SHIFT ▼ (PANIC)** button.



5. Press and release the **POWER/ENTER** button to display the Auto Cal Menu.



6. To check or update the gas concentrations, use the ▲AIR and SHIFT ▼(PANIC) buttons to put the cursor next to **CONCENTRATION** and press and release the POWER/ENTER button to display the Calibration Gas Values Screen.

AUTO		
CONCENTRATION		
>CH4	50	%LEL
O2	12.0	%
H2S	25.0	ppm
CO	50	ppm
VOC	100	ppm
ESCAPE		

The gas concentrations displayed in the Calibration Gas Values Screen must match the gas concentrations listed on the 5-gas cylinder or the 4-gas calibration cylinder and the PID cylinder.

If *all* concentrations match, go to Step 12.

If *one or more* concentrations *do not* match, continue with Step 7.

If you do not want to continue with the concentration adjustment, press and release the DISP/LOCK button to return to the Auto Cal Menu.

---

**NOTE:** The RKI 4-gas cylinder typically contains 12% O<sub>2</sub> by volume. When using the auto calibration method, be sure to set the “O<sub>2</sub>” auto calibration value to agree with the concentration listed on the cylinder’s label, not zero.

---

7. Use the ▲AIR and SHIFT ▼(PANIC) buttons to place the cursor next to the channel whose gas value you want to change.
8. Press and release the POWER/ENTER button. The auto cal value will begin to flash.
9. Use the ▲AIR and SHIFT ▼(PANIC) buttons to adjust the calibration gas setting to the desired value.

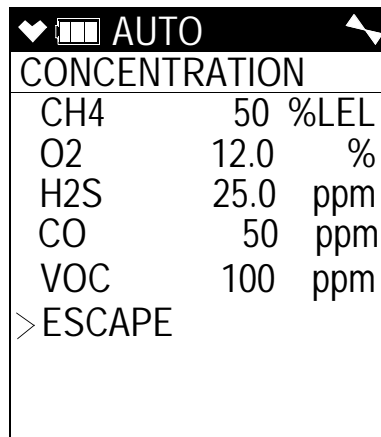
---

**NOTE:** The calibration gas value cannot be set lower than the low alarm setting. If the calibration gas value listed on the calibration cylinder is lower than the current low alarm setting, enter Maintenance Mode and change the low alarm setting. See “Updating the Alarm Point Settings” on page 149 for instructions. If you need to change the alarm point setting only to perform a calibration, make sure that you change the alarm point setting back to its original value once the calibration has been performed.

---

10. Press and release the POWER/ENTER button to save the change. The calibration gas value stops flashing.
11. Repeat Step 7 through Step 10 for any other channels that need to be changed.

- 12 . When you are done adjusting the calibration gas values, move the cursor to **ESCAPE**.

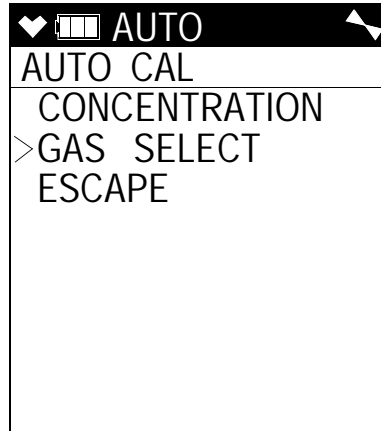


The screenshot shows a menu titled 'AUTO' with a battery icon and a right arrow. Below the title is a section labeled 'CONCENTRATION'. The menu lists the following gas concentrations:

Gas	Concentration	Unit
CH4	50	%LEL
O2	12.0	%
H2S	25.0	ppm
CO	50	ppm
VOC	100	ppm

At the bottom of the list, there is a right arrow followed by the text '> ESCAPE'.

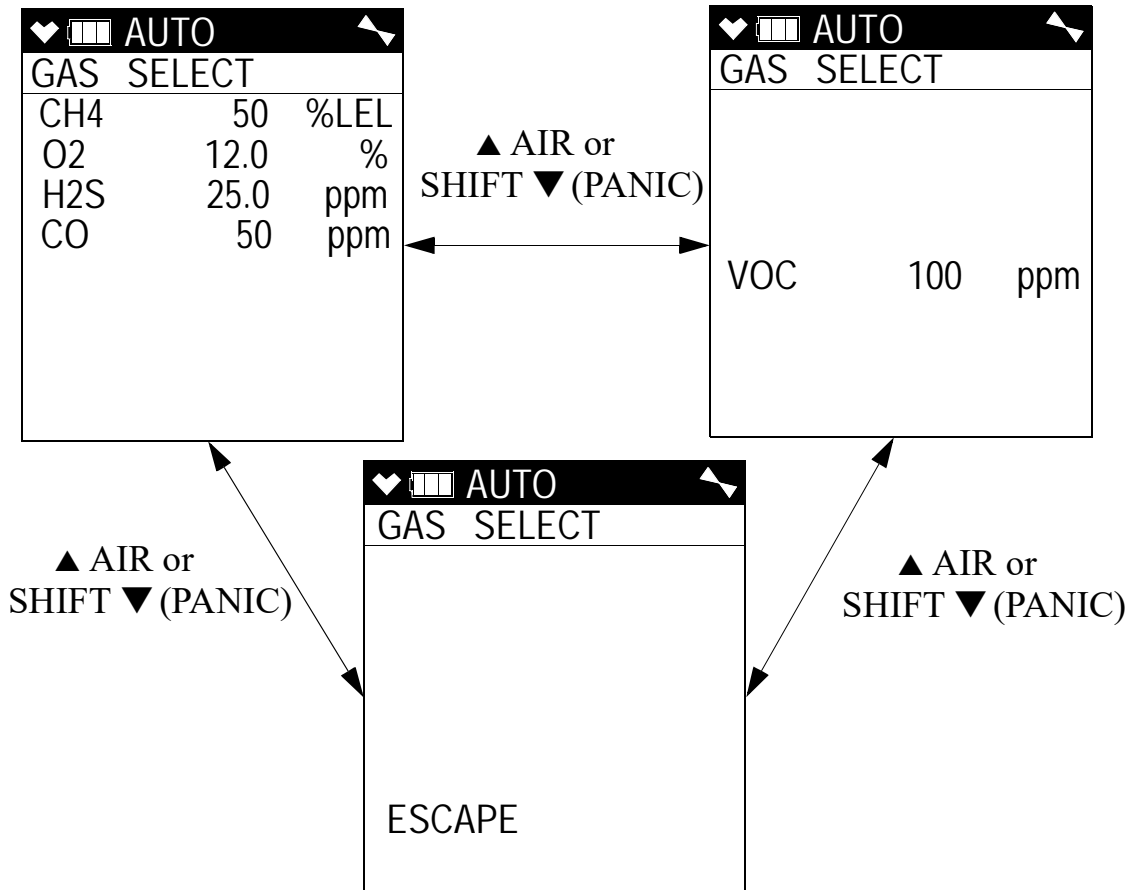
- 13 . Press and release the POWER/ENTER button. The instrument returns to the Auto Cal Menu.
- 14 . Use the ▲AIR and SHIFT ▼(PANIC) buttons to move the cursor next to **GAS SELECT**.



The screenshot shows a menu titled 'AUTO' with a battery icon and a right arrow. Below the title is a section labeled 'AUTO CAL'. The menu lists the following options:

Option
CONCENTRATION
> GAS SELECT
ESCAPE

- 15 . Press and release the POWER/ENTER button. The first of the Gas Select Screens, the standard four sensors screen, will be displayed. In addition to the standard four sensors screen, there is a separate screen for each installed smart sensor, and an **ESCAPE** screen that will take you back to the Auto Cal menu. Use the **▲AIR** and **SHIFT ▼(PANIC)** buttons to scroll through the different screens.



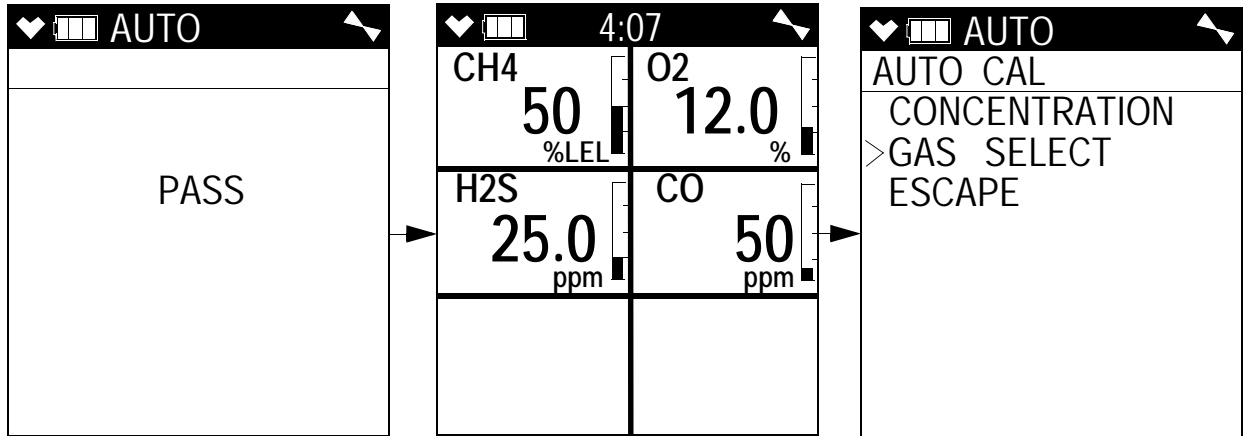
- 16 . With the standard four sensors screen displayed, press and release the POWER/ENTER button to proceed to the Calibration In Process Screen with **APPLYGAS** and the gas readings flashing.

APPLYGAS	
CH4 0 %LEL	O2 20.9 %
H2S 0.0 ppm	CO 0 ppm

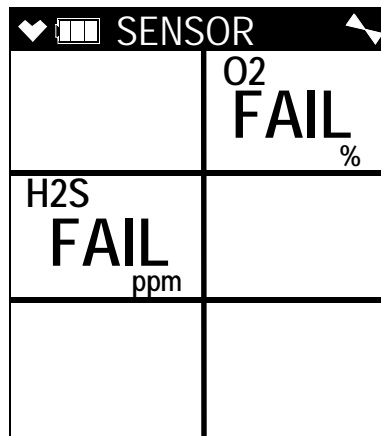
If you do not want to proceed with the calibration, press and release the DISP/LOCK button to return to the Gas Select Screen.

If you do want to continue with the calibration, proceed to the next step.

- 17 . Connect the tubing from the demand flow regulator to the rigid tube on the probe. Allow the GX-6000 to draw gas for one minute.
- 18 . Press and release the POWER/ENTER button to set the span adjustment for each channel to the programmed values.
- 19 . If all channels passed calibration, the following screen sequence occurs.



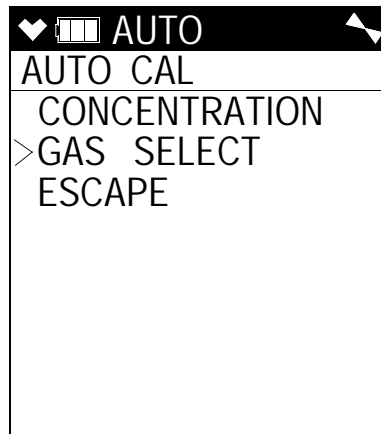
- 20 . If any of the sensors cannot be adjusted to the proper value, a screen displays that indicates a calibration failure and lists the sensor(s) that failed to calibrate. In the example below, the oxygen and H<sub>2</sub>S channels failed calibration. The other sensors calibrated normally.



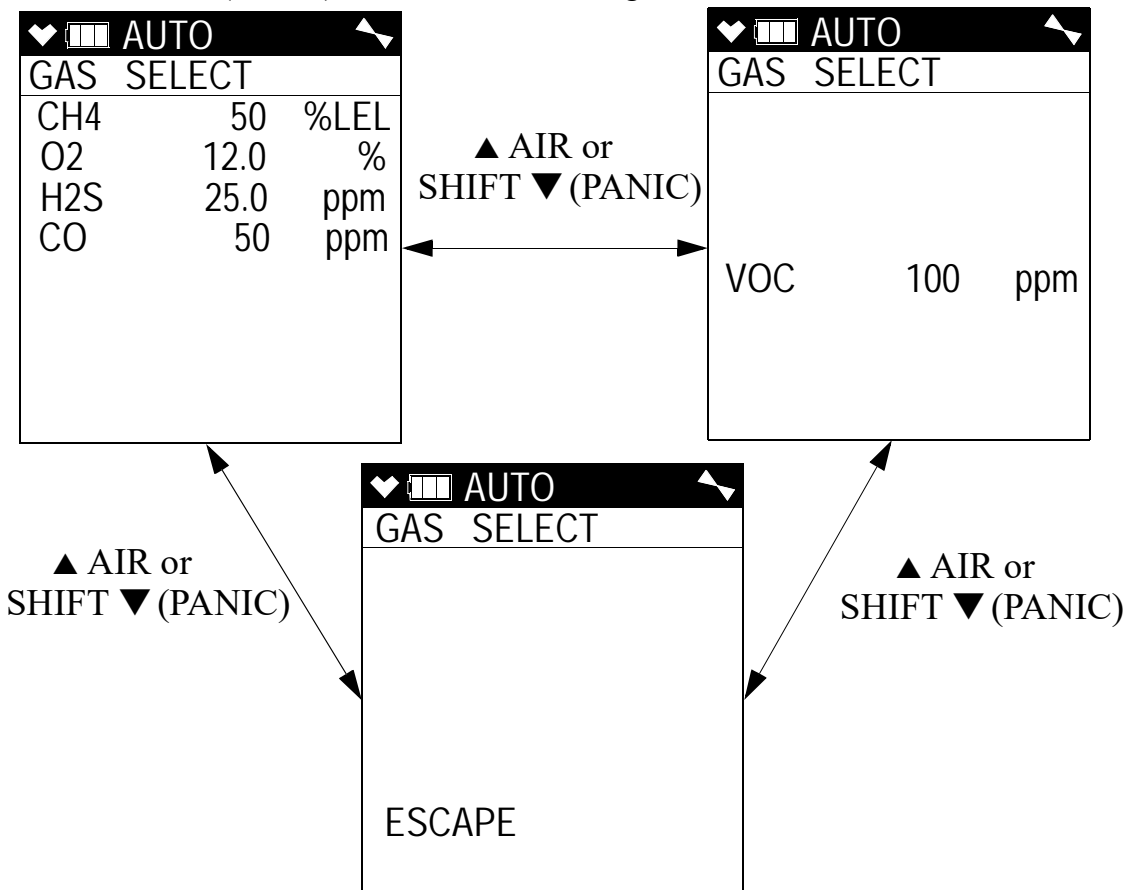
The buzzer and alarm LEDs activate in a double pulsing pattern. Press and release the RESET button to reset the alarm and continue to the Auto Cal Menu. After calibrating the PID channel by following the instructions below, attempt to calibrate the standard channels again. If the failure continues, investigate the cause. See “Troubleshooting” on page 100.

- 21 . If you were using a 5-gas calibration cylinder, continue to Step 22.  
If you were using a 4-gas calibration cylinder:
  - a. Remove the tubing from the rigid tube on the probe.
  - b. Unscrew the 4-gas cylinder from the regulator.
  - c. Screw the PID calibration cylinder onto the demand flow regulator. Continue with Step 23.

- 22 . If you are using a 5-gas calibration cylinder:
- a. Leave the tubing connected to the rigid tube on the probe. Continue with Step 23.
- 23 . Use the ▲AIR and SHIFT ▼(PANIC) buttons to move the cursor next to **GAS SELECT**.

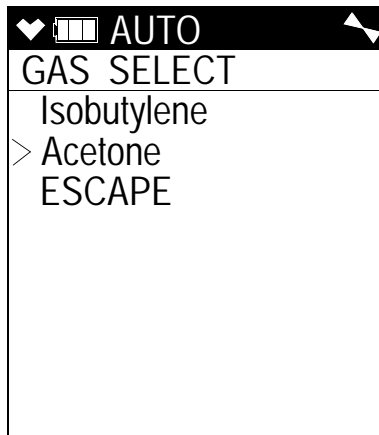


- 24 . Press and release the POWER/ENTER button. The first of the Gas Select Screens, the standard four sensors screen, will be displayed. In addition to the standard four sensors screen, there is a separate screen for each installed smart sensor, and an **ESCAPE** screen that will take you back to the Auto Cal menu. Use the ▲AIR and SHIFT ▼(PANIC) buttons to scroll through the different screens.

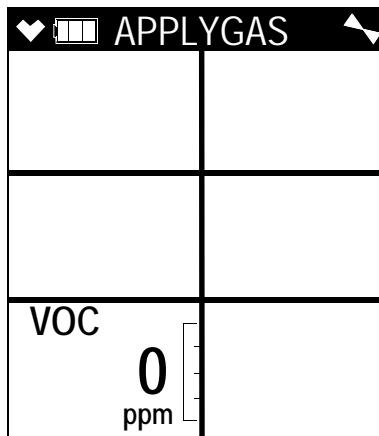




- 25 . With the VOC channel's Gas Select Screen displayed, press and release the POWER/ENTER button. The target gas selection screen will display. This screen allows you to select the gas you want to use for calibration. Isobutylene will always be displayed on the top line. The second line will show the gas that is currently selected in the PID Gas Name Screen in Display Mode. In the example below, acetone is the currently selected gas. If isobutylene is the selected gas, then isobutylene will appear twice in this list.



- 26 . Use the ▲AIR and SHIFT ▼ (PANIC) buttons to move the cursor next to the gas you want to use for calibration.
- 27 . Press and release the POWER/ENTER button to proceed to the Calibration In Process Screen for the PID channel with **APPLYGAS** and the gas reading flashing.



If you do not want to proceed with the calibration, press and release the DISP/LOCK button to return to the Gas Select Screen.

If you do want to continue with the calibration, proceed to the next step.

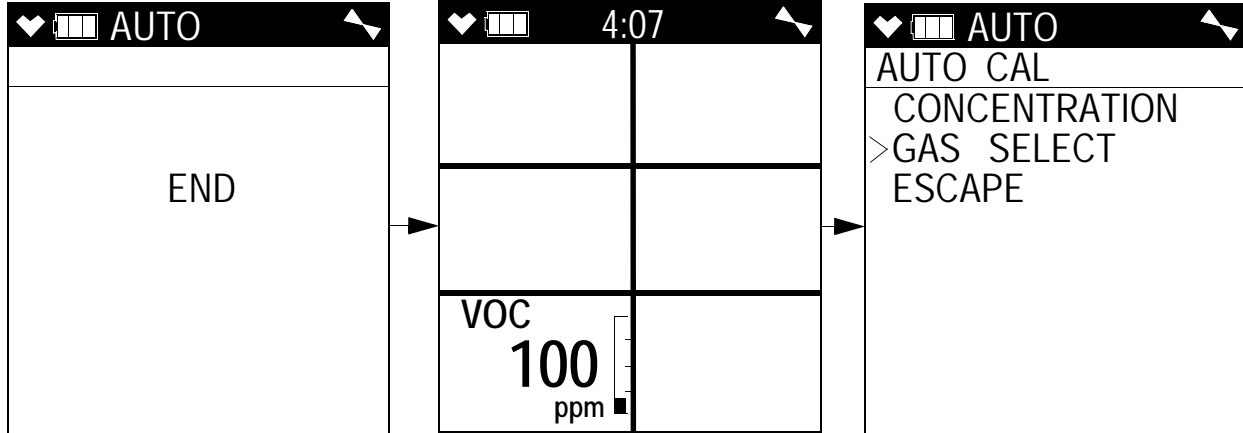
- 28 . If you are using a 5-gas calibration cylinder, continue with Step 29.

If you are using a PID only calibration cylinder:

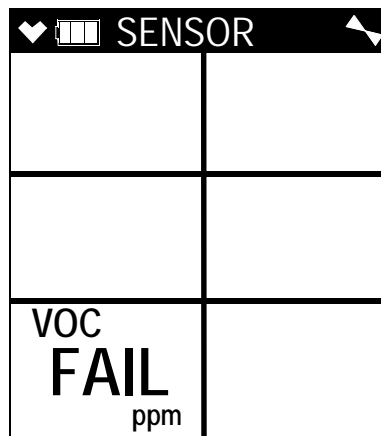
- a. Connect the tubing from the regulator to the rigid tube on the probe. Allow the GX-6000 to draw gas for one minute.
- b. Press and release the POWER/ENTER button to set the span adjustment for the PID channel to the programmed value. Continue with Step 30.

- 29 . If you are using a 5-gas calibration cylinder:
- Since calibration gas has already been flowing to the PID sensor while the other channels were being calibrated, the PID sensor reading should be stable and ready for adjustment.
  - Press and release the POWER/ENTER button to set the span adjustment for the PID channel to the programmed value. Continue with Step 30.

30 . If the PID channel passed calibration, the following screen sequence occurs.



If the PID channel cannot be adjusted to the proper value, a screen displays that indicates a calibration failure and indicates that the PID sensor failed to calibrate.



The buzzer and alarm LEDs activate in a double pulsing pattern. Press and release the RESET button to reset the alarm and continue to the Auto Cal Menu. Attempt to calibrate the PID channel again. If the failure continues, investigate the cause. See “Troubleshooting” on page 100.

### Returning to Measuring Mode

- Disconnect the tubing from the probe.
- Unscrew the demand flow regulator from the calibration cylinder.
- Use the SHIFT ▼ (PANIC) button to move the cursor next to **ESCAPE**, then press and release the POWER/ENTER button to return to the Calibration Mode Menu.
- Use the SHIFT ▼ (PANIC) button to place the cursor next to the **NORMAL MODE** menu option, then press and release the POWER/ENTER button to return to Measuring Mode.

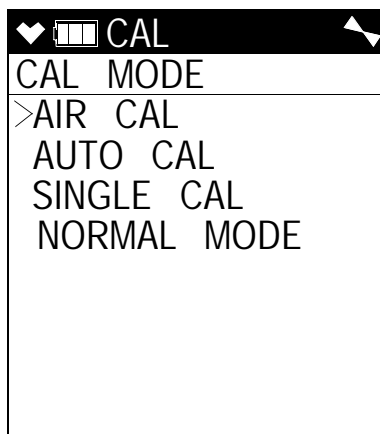
---

## Calibrating Using the Single Calibration Method

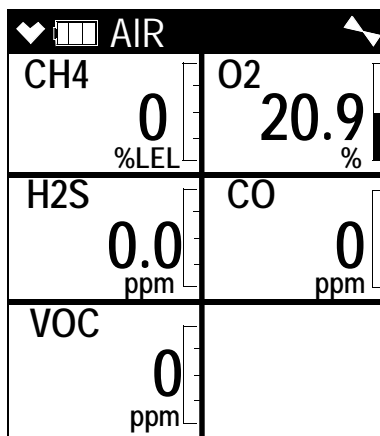
Single Calibration allows you to calibrate one channel at a time. This is useful if you only want to calibrate one or two channels.

### Setting the Fresh Air Reading

1. While in the Calibration Mode Screen, move the cursor to the **AIR CAL** menu item by using the SHIFT ▼ (PANIC) button.



2. Press and release the POWER/ENTER button. The Fresh Air Reading Screen will be displayed.



3. If you suspect any low-level VOC background in the area, you will need to use the VOC zero filter.

---

**NOTE:** If you have both a PID and a CO<sub>2</sub> sensor installed, you will need to follow the directions in “Performing a Demand Zero for Instruments with a Carbon Dioxide Sensor and a PID Sensor” on page 184 instead of following the directions shown below.

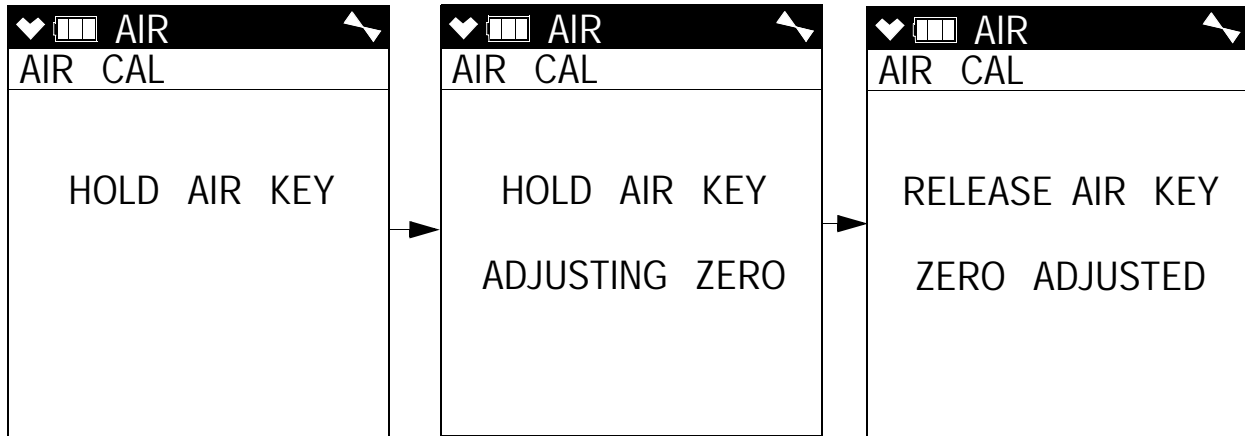
---

- a. Remove the plug from each end of the VOC zero filter.
- b. Attach the VOC zero filter to the inlet fitting or probe. The filter does not have a preferred flow direction.

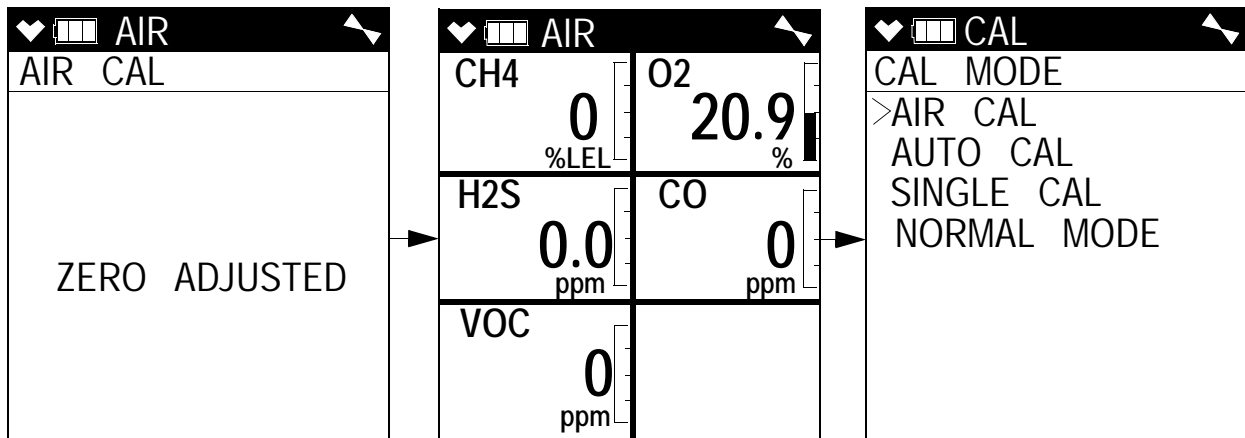
- c. Let the instrument draw through the VOC zero filter for 1 minute before continuing.
4. To continue with the fresh air adjustment, press and hold the ▲AIR button.

If you do not want to continue, press and release the DISP/LOCK button and the unit will return to the Calibration Mode Screen.

5. The GX-6000 will indicate that it is adjusting the zero reading for a few seconds and then it will prompt you to release the ▲AIR button.



6. Release the ▲AIR button. The fresh air adjustment will finish, the fresh air readings will be displayed momentarily, and then the instrument will return to the Calibration Mode Screen.

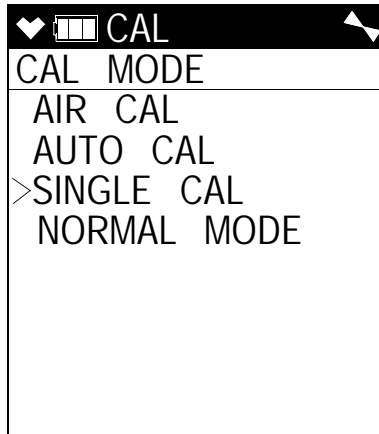


7. If the VOC zero filter was used, remove the filter from the GX-6000's inlet fitting or probe. Reinstall the plugs on each end of the filter.

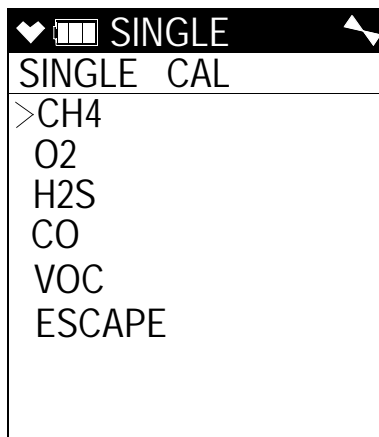
### Performing a Span Adjustment in Single Calibration

1. Install the demand flow regulator onto the calibration cylinder.
2. Connect the sample tubing to the demand flow regulator.
3. Install the sample hose and probe on the GX-6000 inlet fitting. Make sure the probe's two halves are tightened firmly together to avoid leaks that can affect the calibration. See Figure 22, "Replacing the Particle Filter and Hydrophobic Filter Disk" on page 112 for an illustration of the internal parts of the probe.

4. Move the cursor next to the **SINGLE CAL** menu item by using the ▲AIR or SHIFT ▼(PANIC) button.



5. Press and release the POWER/ENTER button. The Select Sensor Screen appears.



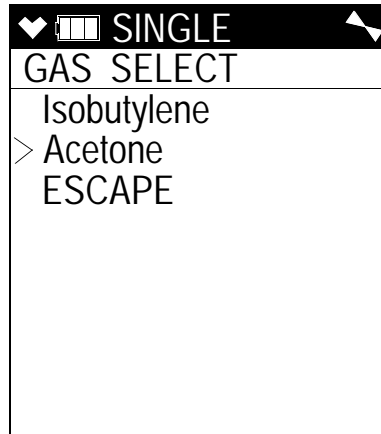
6. Move the cursor next to the sensor you want to calibrate with the ▲AIR and SHIFT ▼(PANIC) buttons. In the example above, the CH<sub>4</sub> sensor is selected for span adjustment.

If you do not want to proceed with the span adjustment, press and release the DISP/LOCK button or place the cursor next to **ESCAPE** and press and release POWER/ENTER to return to the Calibration Mode Screen.

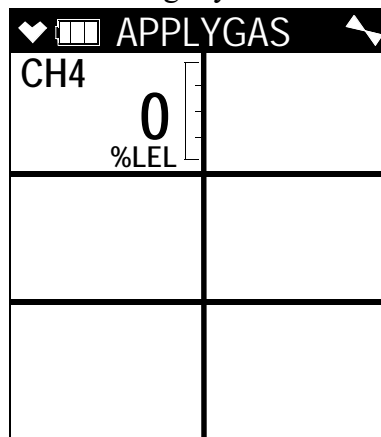
To proceed with the calibration, continue with the next step.

7. For a CH<sub>4</sub>, O<sub>2</sub>, H<sub>2</sub>S, or CO channel continue to Step 10.  
For a VOC channel, see Step 8 and Step 9 before continuing with Step 10.

- 8 . Press and release the POWER/ENTER button. The target gas selection screen will display. This screen allows you to select the gas you want to use for calibration. Isobutylene will always be displayed on the top line. The second line will show the gas that is currently selected in the PID Gas Name Screen in Display Mode. In the example below, acetone is the currently selected gas. If isobutylene is the selected gas, then isobutylene will appear twice in this list.

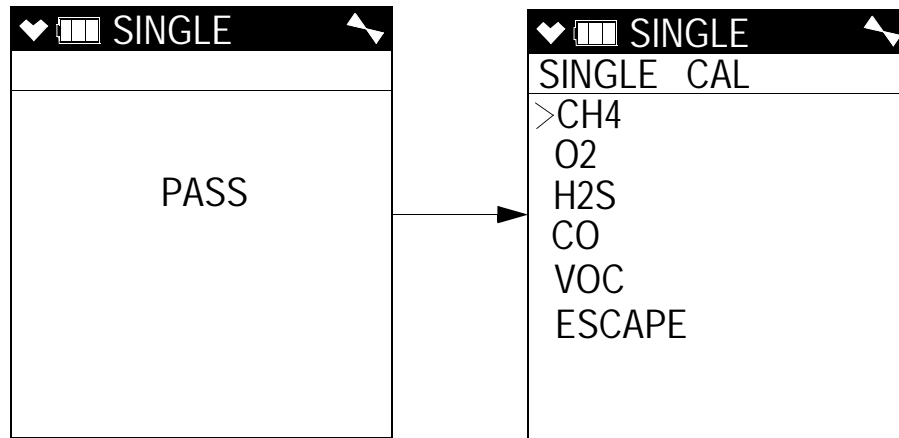


- 9 . Use the ▲AIR and SHIFT ▼(PANIC) buttons to move the cursor next to the gas you want to use for calibration. Continue to Step 10.
- 10 . Press and release the POWER/ENTER button to proceed to the Single Calibration Apply Gas Screen. **APPLYGAS** and the gas reading will be flashing. The screen shown below is for the CH<sub>4</sub> channel. If you are calibrating a different channel, your screen will look slightly different.



- 11 . Connect the tubing from the demand flow regulator to the rigid tube on the probe. Allow the GX-6000 to draw gas for one minute.
- 12 . If necessary, adjust the reading to match the cylinder concentration with the ▲AIR and SHIFT ▼(PANIC) buttons. If the reading cannot be adjusted to match the cylinder concentration, see “Troubleshooting” on page 100.

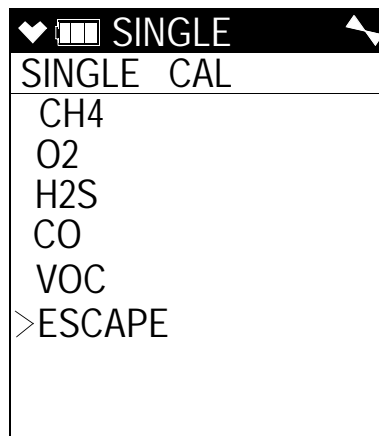
- 13 . Press and release the POWER/ENTER button to save the span value. The LCD will indicate that the calibration has ended, then the Select Sensor Screen appears.



- 14 . Disconnect the tubing from the GX-6000's probe.
- 15 . Repeat Step 6 through Step 14 for any other channels you want to calibrate. Make sure you use an appropriate calibration cylinder for each sensor.

**CAUTION:** When calibrating the oxygen sensor, verify the concentration of oxygen listed on the cylinder's label. For oxygen-free samples (100% nitrogen for example), set the oxygen calibration value to 0.0%.

- 16 . After the last channel is calibrated, disconnect the calibration tubing from the probe, then unscrew the demand flow regulator from the calibration cylinder.
- 17 . With the Select Sensor Screen displayed, place the cursor next to **ESCAPE** using the ▲AIR or SHIFT ▼(PANIC) button.



- 18 . Press and release the POWER/ENTER button to return to the Calibration Mode Screen.
- 19 . Use the SHIFT ▼(PANIC) button to place the cursor next to the **NORMAL MODE** menu item, then press and release the POWER/ENTER button to return to Measuring Mode.

---

## Performing a Bump Test

---

**NOTE:** The **BUMP DISP** menu item in Maintenance Mode is factory set to **OFF**. The **BUMP TEST** menu item will not appear unless **BUMP DISP** is set to **ON**. See “Updating the Bump Display Setting” on page 144 for instructions.

---

**NOTE:** The GX-6000 uses parameters defined in the **BUMP PARAMETERS** menu item of Maintenance Mode while performing a bump test. To view or update these parameters, see “Updating the Bump Parameters” on page 145.

---

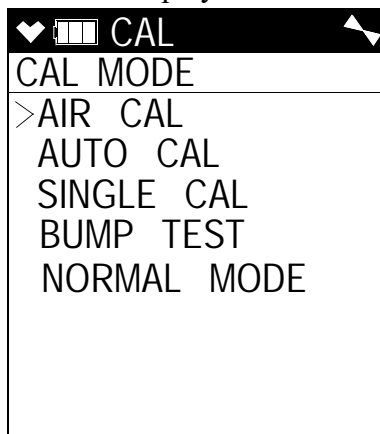
If the combustible gas channel is calibrated to a gas other than methane, use an appropriate multigas cylinder.

1. Install the demand flow regulator onto the calibration cylinder.
  2. Connect the sample tubing to the demand flow regulator.
  3. Install the sample hose and probe on the GX-6000 inlet fitting. Make sure the probe’s two halves are tightened firmly together to avoid leaks that can affect the calibration. See Figure 22, “Replacing the Particle Filter and Hydrophobic Filter Disk” on page 112 for an illustration of the internal parts of the probe.
  4. While in Measuring Mode, press and hold the **SHIFT ▼ (PANIC)** button, then press the **DISP/LOCK** button and release both buttons.
  5. If the unit prompts you for the password, enter it by using the **▲AIR** and **SHIFT ▼ (PANIC)** buttons to select each password number and then pressing and releasing **POWER/ENTER** to enter the number and move on to the next one.
- 

**NOTE:** You will only be prompted to enter a password if the **PASSWORD** menu item in User Mode is set to **ON**. See “Turning the Password Function On or Off” on page 98 for instructions to update the **PASSWORD** setting and to choose a password.

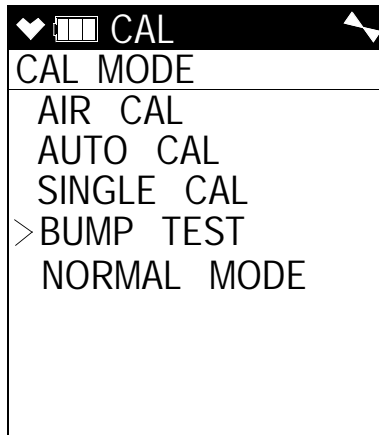
---

6. The Calibration Mode Screen displays with the cursor next to **AIR CAL**.

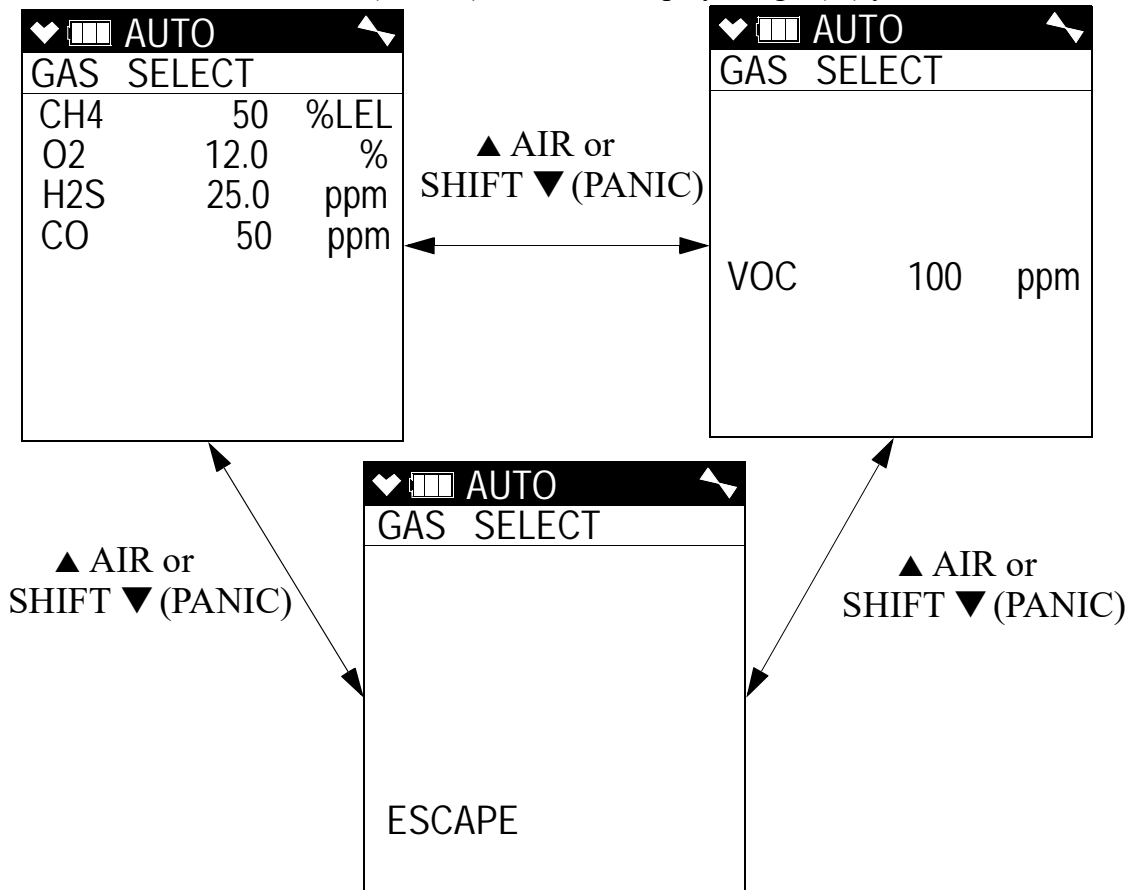




7. Move the cursor next to the **BUMP TEST** menu item by using the SHIFT ▼ (PANIC) button.

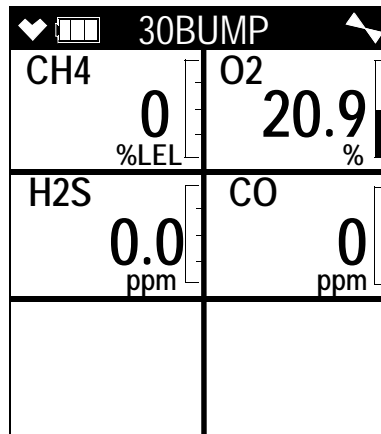


8. Press and release the POWER/ENTER button. The first of the Gas Select Screens, the standard four sensors screen, will be displayed. In addition to the standard four sensors screen, there is a separate screen for each installed smart sensor, and an **ESCAPE** screen that will take you back to the Calibration Mode menu. Use the ▲AIR and SHIFT ▼ (PANIC) buttons to display the gas(es) you want to test.



9. Before proceeding, confirm that the bump test gas value(s) are the same as the concentration(s) in the calibration cylinder. If they are not, adjust the bump test gas value(s) by entering the **AUTO CAL** menu item in Calibration Mode, changing the value(s) there, and reentering the **BUMP TEST** menu item.

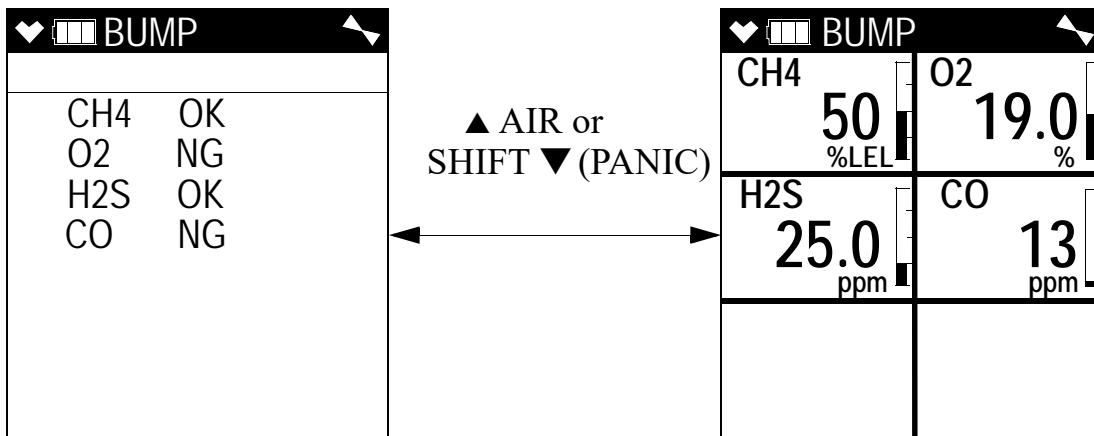
- 10 . With the desired sensor screen displayed, connect the tubing from the demand flow regulator to the rigid tube on the probe then quickly press and release the POWER/ENTER button to proceed to the Bump In Progress Screen. The instrument will count down.



If you do not want to proceed with the bump test, press and release the DISP/LOCK button to return to the Gas Select Screen.

If you do want to continue with the bump test, proceed to the next step.

- 11 . When **AUTO CAL** in the **BUMP PARAMETERS** menu item in Maintenance Mode is set to **OFF**:
- The instrument will indicate which channels passed or failed the bump test with an OK (pass) or an NG (fail) to the right of the gas. You can scroll between the bump test results and the bump test gas readings with the ▲AIR and SHIFT ▼ (PANIC) button.



- To return to the Gas Select Screen, press and release the POWER/ENTER button. If any channel failed the bump test, the buzzer will sound a double pulsing tone until you press and release the POWER/ENTER button.

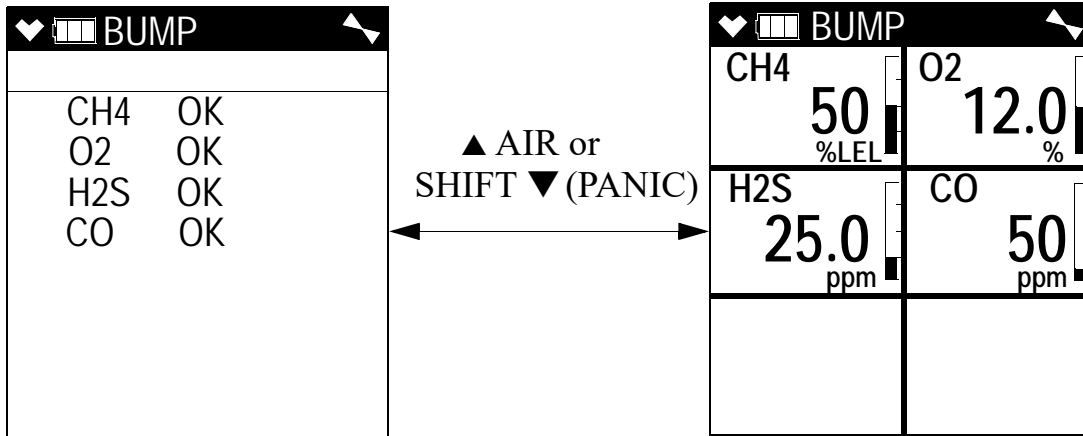
If one or more sensors fail the bump test, see “Troubleshooting” on page 100 to investigate the cause of the failure and replace the failed sensor or sensors if necessary.

- Disconnect the tubing from the probe.

12 . When **AUTO CAL** in the **BUMP PARAMETERS** menu item in Maintenance Mode is set to **ON**:

**If all channels pass the bump test:**

- a. The results screen appears. You can scroll between the bump test results and the bump test gas readings with the **▲AIR** and **SHIFT ▼(PANIC)** buttons.

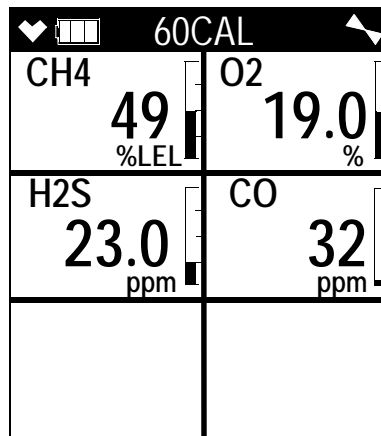


- b. To return to the Gas Select Screen, press and release the **POWER/ENTER** button.
- c. Disconnect the tubing from the probe.

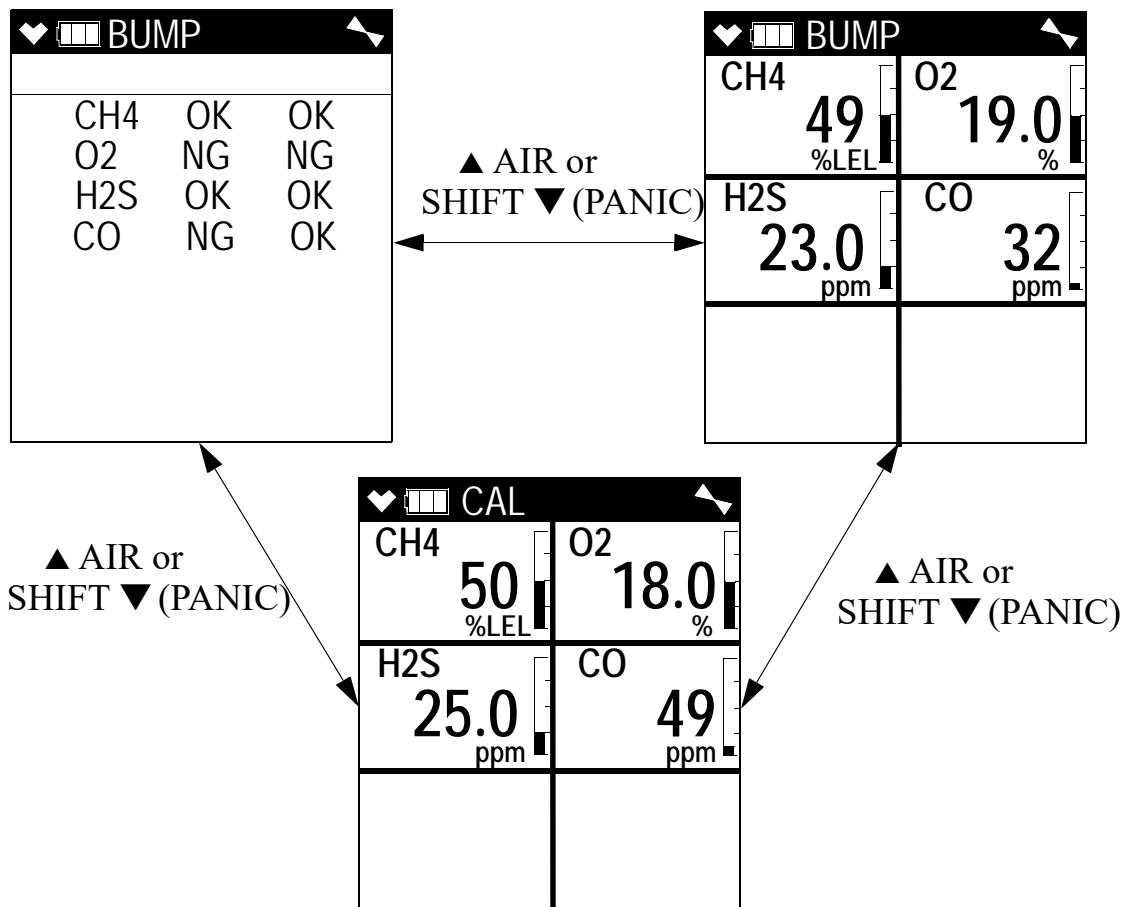
**If any channel fails the bump test:**

- a. The instrument will beep and a calibration is immediately and automatically started. Continue to apply the calibration gas. **CAL** will appear at the top of the screen along with a countdown.

The calibration time counted down during a calibration initiated because of a failed bump test is the difference between the gas time and the calibration time defined in the **BUMP SETTING** menu item in Maintenance Mode.



- b. At the end of the calibration, the instrument displays the results from both the bump test and the calibration. Use the ▲AIR and SHIFT ▼(PANIC) button to scroll between the calibration/bump test results, the bump test gas readings, and the calibration gas readings.



- c. To return to the Gas Select Screen, press and release the POWER/ENTER button at any time. If any channel failed the calibration, the buzzer will sound a double pulsing tone until you press and release the POWER/ENTER button.
- d. Disconnect the tubing from the probe.
- 13 . Unscrew the demand flow regulator from the calibration cylinder.
  - 14 . If you want to bump test any more channels, repeat Step 13 - Step 13.
  - 15 . Use the SHIFT ▼(PANIC) button to display the **ESCAPE** screen, then press and release the POWER/ENTER button to return to the Calibration Mode Menu.
  - 16 . Use the SHIFT ▼(PANIC) button to place the cursor next to the **NORMAL MODE** menu option, then press and release the POWER/ENTER button to return to Measuring Mode.

# Chapter 5: User Mode

---

## Overview

This section describes the GX-6000 in User Mode. See Table 12 below for a list of the items found in User Mode, the page that the menu item's instructions can be found on, and a short description of the menu item.

**Table 12: User Mode Menu Items**

Menu Item (page number)	Description
DATE (pg.95)	Set the instrument's date and time
DATE FORMAT (pg.95)	Set the date format
CONFIGURE CH (pg.95)	Change sensor/channel assignment
LANGUAGE (pg.97)	Change the instrument's language
ROM/SUM (pg.98)	View the instrument's ROM number and checksum
PASSWORD (pg.98)	Turn the User Mode password function on or off and update the password
START MEASURE (pg.99)	Return to Measuring Mode

---

## Tips for Using User Mode

- When in the main menu, the cursor (>) indicates which menu item will be selected if the POWER/ENTER button is pressed and released.
- Use the SHIFT ▼ (PANIC) button to move the cursor down through the main menu and submenu items, and to lower values or change the setting in a specific option.
- Use the ▲AIR button to move the cursor up through the main menu and submenu items, and to raise values or change the setting in a specific option.
- Use the POWER/ENTER button to enter a selected menu item with the cursor next to it and to enter and save settings during programming.
- An adjustable parameter that is flashing can be adjusted with the ▲AIR and SHIFT ▼ (PANIC) buttons.
- Press the DISP/LOCK button while in a screen where you are entering or updating parameters to exit the screen without saving any changes.

---

## Entering User Mode

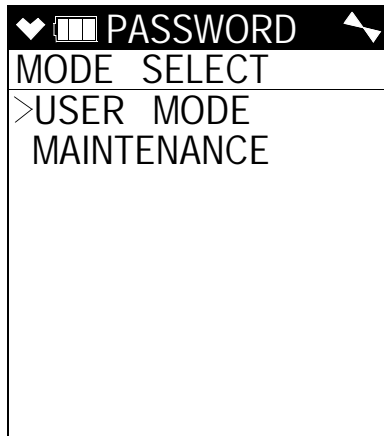
**WARNING:** *The GX-6000 is not in operation as a gas detector while in User Mode.*

1. Take the GX-6000 to a non-hazardous location and turn it off if it is on.
2. Press and hold the ▲AIR and SHIFT ▼ (PANIC) buttons, then press and hold the POWER/ENTER button. When you hear a beep, release the buttons.

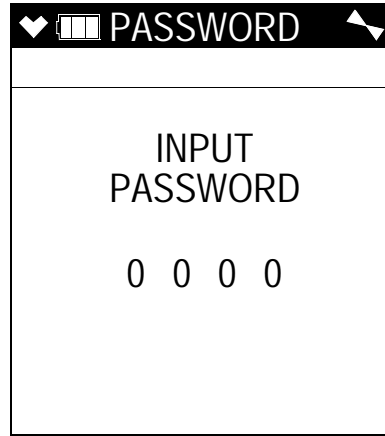
3. The screen that appears will depend on the setting of User Mode's **PASSWORD** item.

If **PASSWORD** is set to **OFF** (factory setting), continue with Step 4.

If **PASSWORD** is set to **ON**, continue with Step 6.

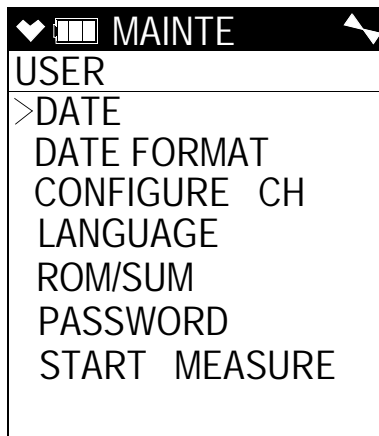


**PASSWORD** set to **OFF**



**PASSWORD** set to **ON**

4. If **PASSWORD** has been set to **OFF**, the Mode Select screen will appear, prompting you to choose the mode you'd like to enter.
5. Use the **▲AIR** and **SHIFT ▼(PANIC)** buttons to put the cursor in front of **USER MODE** and press and release the **POWER/ENTER** button. Continue to Step 8.
6. If **PASSWORD** has been set to **ON** in User Mode, a password screen will appear. The first digit will be flashing.
7. Enter the password by using the **▲AIR** and **SHIFT ▼(PANIC)** buttons to select each password number and then pressing and releasing the **POWER/ENTER** button to enter it and move on to the next number until all of the numbers are entered. Continue to Step 8.
8. The main menu displays. It has 7 menu items.



9. Use the **▲AIR** or **SHIFT ▼(PANIC)** button to move the cursor up and down the menu items.

---

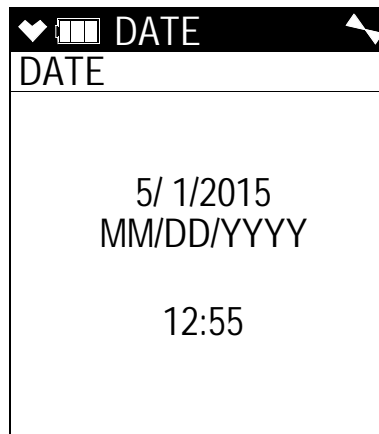
## Setting the Date and Time

---

**NOTE:** The example screen shown below assumes a **DATE FORMAT** setting of **MM/DD/YYYY** (factory setting). If your instrument's **DATE FORMAT** is set to something else, your screen will appear different.

---

1. From the main menu, place the cursor next to **DATE**.
2. Press and release **POWER/ENTER**. The date and time will be displayed with the year flashing.



3. Use **▲AIR** or **SHIFT ▼ (PANIC)** to display the desired year.
  4. Press and release **POWER/ENTER** to save the setting. The month setting flashes.
  5. Repeat Step 3 and Step 4 to enter the month, day, hours, and minutes settings. The main menu displays after you enter the seconds setting.
- 

## Setting the Date Format

The date can be displayed in three ways, **MM/DD/YYYY** (factory setting), **DD/MM/YYYY**, or **YYYY/MM/DD**.

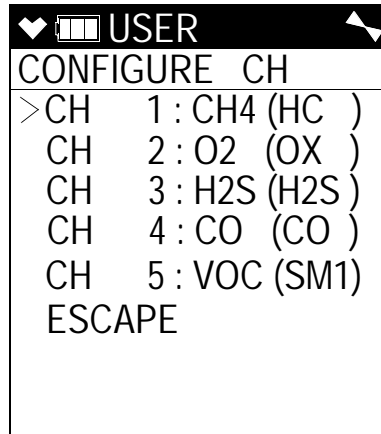
1. From the main menu, place the cursor next to **DATE FORMAT**.
  2. Press and release **POWER/ENTER**. The Date Format screen appears with the current setting flashing.
  3. Use **▲AIR** or **SHIFT ▼ (PANIC)** to display the desired setting.
  4. Press and release **POWER/ENTER** to save the setting and return to the main menu.
- 

## Configuring the Channels

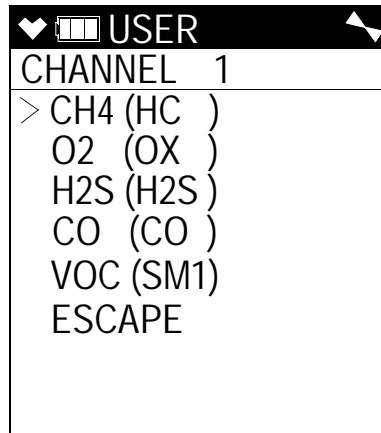
The **CONFIGURE CH** menu item allows you to rearrange the display order of the active channels.

1. From the main menu, place the cursor next to **CONFIGURE CH**.

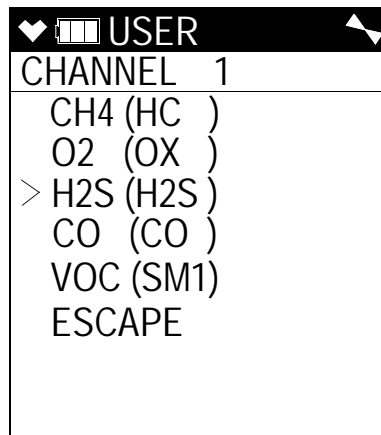
2. Press and release POWER/ENTER. The Configure Channels screen appears with the cursor next to **CH1**.



3. Use ▲AIR or SHIFT ▼ (PANIC) to move the cursor next to the channel you want to configure.
4. Press and release POWER/ENTER. The available configuration options are shown. The current setting for the channel will be flashing.



5. Use ▲AIR and SHIFT ▼ (PANIC) to move the cursor next to the desired configuration for the selected channel. In the example below, the cursor has been moved next to the **H2S (H2S )** selection.





6. Press and release POWER/ENTER to select the channel configuration.

---

**NOTE:** Each channel must have a gas assignment. If you change one channel's gas to something else, the two affected channels will end up swapping places. In the example above, when you select H<sub>2</sub>S as channel 1's new gas, CH<sub>4</sub>, which used to be channel 1, would automatically be assigned to channel 3, H<sub>2</sub>S' old channel.

---

7. Repeat Step 5 and Step 6 for any other channels you want to configure.
8. Use SHIFT ▼ (PANIC) to move the cursor next to the **ESCAPE** menu item.

---

**NOTE:** If you want to exit to the main menu without saving any channel configuration changes, press and release DISP/LOCK.

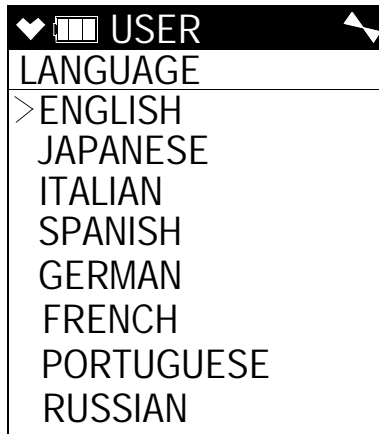
---

9. Press and release POWER/ENTER to save the changes and return to the main menu.

---

## Updating the Language Setting

The **LANGUAGE** menu item allows you to select the language for the GX-6000's user interface. The available choices are English (factory setting), Japanese, Italian, Spanish, German, French, Portuguese, Russian, and Korean.



1. From the main menu, place the cursor next to **LANGUAGE**.
2. Press and release POWER/ENTER. The Select Language Screen appears with the cursor in front of the current language.
3. Use ▲AIR or SHIFT ▼ (PANIC) to move the cursor in front of the desired language.

If you do not wish to select a new language, press and release DISP/LOCK. The unit will return to the main menu.

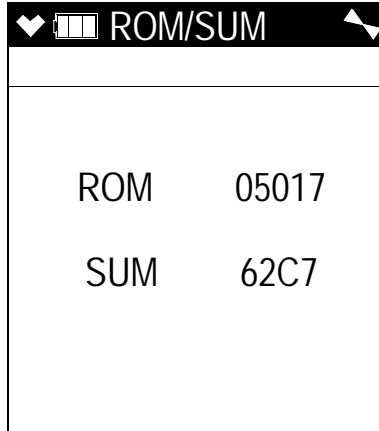
4. Press and release POWER/ENTER to save the new language setting and return to the main menu. The GX-6000's user interface will now be in the newly selected language.

---

## Viewing the ROM/SUM of the Instrument

The **ROM/SUM** screen shows the firmware version that is loaded in the instrument and the firmware checksum.

1. Use the ▲AIR or SHIFT ▼(PANIC) button to place the cursor next to **ROM/SUM**.
2. Press and release the POWER/ENTER button. The ROM and checksum values for your unit will be displayed.



3. The first line displays the ROM number. The ROM number indicates the firmware version number. In the above example, the ROM number is 05017. The bottom line displays the firmware file's checksum, 62C7 in the above example.
4. Press and release the POWER/ENTER button again to return to the main menu.

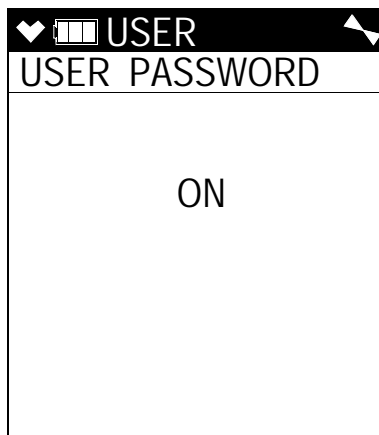
---

## Turning the Password Function On or Off

With **PASSWORD** set to **ON**, the GX-6000 prompts you for a password when you enter User Mode and Calibration Mode.

With **PASSWORD** set to **OFF** (factory setting), no password is required to enter User Mode or Calibration Mode.

1. From the main menu, place the cursor in front of **PASSWORD**.
2. Press and release POWER/ENTER. The Password Protection Screen appears.

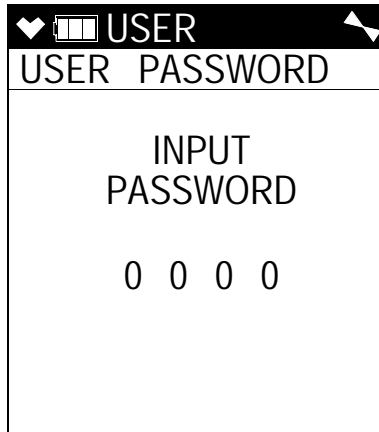


3. Use ▲AIR or SHIFT ▼(PANIC) to display the desired setting.

4. If you selected **OFF**, press and release POWER/ENTER to save the setting and return to the main menu.

If you selected **ON**, continue with Step 5.

5. Press and release POWER/ENTER. The Set Password Screen appears. 0000 is at the bottom of the screen with the first 0 flashing.



6. Use **▲AIR** or **SHIFT ▼(PANIC)** to display a number from 0 to 9.
7. Press and release POWER/ENTER to enter the selection and advance to the next number.
8. Repeat Step 6 and Step 7 to select the remaining numbers. When you press and release POWER/ENTER to enter the last number, the password is saved and you return to the main menu.

---

## Exiting User Mode

1. From the main menu, place the cursor in front of **START MEASURE** at the bottom of the menu.
2. Press and release POWER/ENTER.
3. The unit will begin its start-up sequence.

# Chapter 6: Maintenance

## Overview

This chapter describes troubleshooting procedures for the GX-6000. It also includes procedures for replacing and recharging the batteries and replacing various consumable parts.

**WARNING:** *RKI Instruments, Inc. recommends that service, calibration, and repair of RKI Instruments be performed by personnel properly trained for this work. Replacing sensors and other parts with original equipment does not affect the intrinsic safety of the instrument.*

## Troubleshooting

The troubleshooting table describes error messages, symptoms, probable causes, and recommended action for problems you may encounter with the GX-6000.

**Table 13: Troubleshooting the GX-6000**

Symptoms	Probable Causes	Recommended Action
<ul style="list-style-type: none"><li>The LCD is blank.</li></ul>	<ul style="list-style-type: none"><li>The unit may have been turned off.</li><li>The alkaline batteries may need to be replaced or Li-ion battery pack may need to be recharged.</li></ul>	<ol style="list-style-type: none"><li>To turn on the unit, press and briefly hold the POWER/ENTER button.</li><li>If the unit does not turn on, replace the alkaline batteries or recharge the Li-ion battery pack.</li><li>If the difficulties continue, contact RKI Instruments, Inc. for further instruction.</li></ol>
<ul style="list-style-type: none"><li>The LCD shows abnormally high or low readings but other gas detection instruments do not.</li></ul>	<ul style="list-style-type: none"><li>The H<sub>2</sub>S scrubber disk or charcoal filter may need to be replaced.</li><li>The GX-6000 may need to be recalibrated.</li><li>The sensor for the affected channel(s) may need replacement.</li></ul>	<ol style="list-style-type: none"><li>Replace the H<sub>2</sub>S scrubber disk or charcoal filter.</li><li>Recalibrate the unit.</li><li>If the difficulties continue, replace the sensor for the affected channel(s) and calibrate the affected channel(s).</li><li>If the difficulties continue, contact RKI Instruments, Inc. for further instruction.</li></ol>

**Table 13: Troubleshooting the GX-6000**

<b>Symptoms</b>	<b>Probable Causes</b>	<b>Recommended Action</b>
<ul style="list-style-type: none"> <li>The unit indicates flow failure and does not recover when RESET is pressed and released.</li> </ul>	<ul style="list-style-type: none"> <li>The probe tube is clogged.</li> <li>The hydrophobic filter disk in the probe is dirty.</li> <li>The sample hose has a kink or obstruction.</li> <li>The pump is malfunctioning.</li> </ul>	<ol style="list-style-type: none"> <li>Inspect the probe tube for any obstructions.</li> <li>Inspect the hydrophobic filter disk in the probe and replace if necessary.</li> <li>Inspect the sample hose for kinks or obstructions and replace if necessary.</li> <li>Attempt to set the low flow setpoint as described in "Adjusting the Low Flow Setpoint" on page 159.</li> <li>If difficulties continue, contact RKI Instruments, Inc. for further instruction.</li> </ol>
<ul style="list-style-type: none"> <li>Auto calibration or single calibration fails.</li> </ul>	<ul style="list-style-type: none"> <li>The auto calibration values may not match the cylinder gas concentrations (auto calibration only).</li> <li>The charcoal filter is saturated causing an elevated CO reading.</li> <li>The sample gas is not reaching the sensors because of a bad connection.</li> <li>The calibration cylinder may be out of gas or is outdated.</li> <li>For PID sensors, the lamp may need to be cleaned.</li> <li>For PID sensors, the electrode stack may need to be replaced.</li> <li>The sensor for the affected channel(s) may need replacement.</li> </ul>	<ol style="list-style-type: none"> <li>Check all calibration tubing for leaks or for any bad connections.</li> <li>Make sure the GX-6000 has been properly set up for calibration.</li> <li>Change the charcoal filter.</li> <li>Verify that the calibration cylinder contains an adequate supply of fresh test sample.</li> <li>Clean the PID sensor's lamp.</li> <li>Replace the PID sensor's electrode stack.</li> <li>If the fail condition continues, replace the sensor(s).</li> <li>If the difficulties continue, contact RKI Instruments, Inc. for further instruction.</li> </ol>
<ul style="list-style-type: none"> <li>Heart symbol at the top of the screen becomes steadily on or disappears</li> </ul>	<ul style="list-style-type: none"> <li>A microprocessor error has occurred.</li> </ul>	<ul style="list-style-type: none"> <li>Contact RKI Instruments, Inc. for further instruction.</li> </ul>
<ul style="list-style-type: none"> <li>Instrument does not go into low flow alarm when inlet is plugged.</li> </ul>	<ul style="list-style-type: none"> <li>Sensor gasket is not seated properly.</li> </ul>	<ul style="list-style-type: none"> <li>Turn the instrument off and remove the flow chamber. Ensure that the sensor gasket's flow fitting connections are facing up and that the gasket is secured under the gasket aligning tabs.</li> </ul>

---

## Replacing or Recharging the Batteries

**WARNING:** *To prevent ignition of a hazardous atmosphere, batteries must only be changed or charged in an area known to be nonhazardous.*

**AVERTISSEMENT:** *Pour éviter l'inflammation d'une atmosphère dangereuse, les batteries doivent uniquement être modifiées ou facturés dans une zone connue comme non dangereuse.*

Replace or recharge the batteries when the battery icon indicates that the unit is in low battery warning. When in low battery warning, the lowest battery level indication bar disappears and the battery icon will be flashing.

### Replacing Alkaline Batteries

---

**NOTE:** Use Procell PC 1500 alkaline batteries or RKI Instruments, Inc. lithium-ion battery pack 49-1619 to maintain the CSA classification of the GX-6000. Use of other batteries will void the CSA classification and may void the warranty. Do not mix old/new or different types of batteries.

---

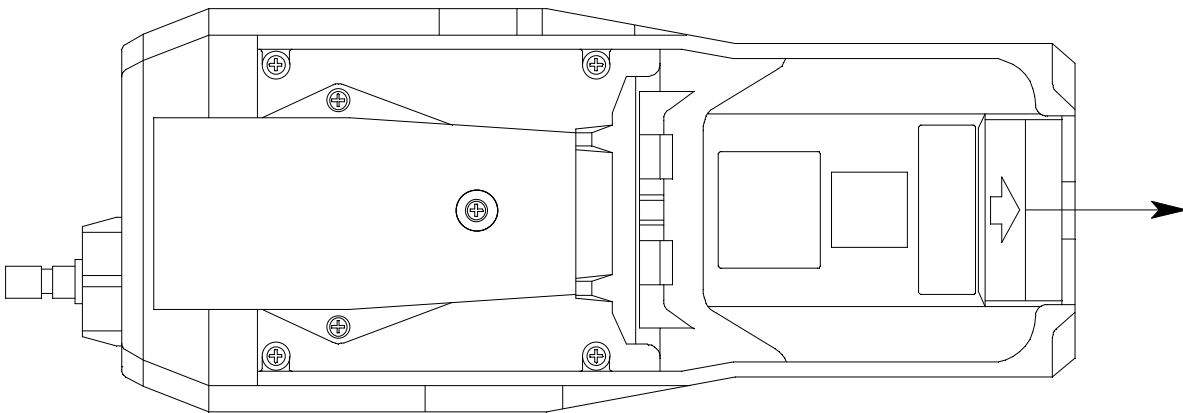
**NOTE:** Utiliser Procell 1500 piles alcalines ou RKI Instruments, Inc. pack batterie lithium-ion 49-1619 de maintenir la classification CSA de la GX-6000. L'utilisation d'autres piles annule la classification CSA et peut annuler la garantie. Ne mélangez pas les anciennes/nouvelles ou différents types de piles.

---

1. Turn off the GX-6000.

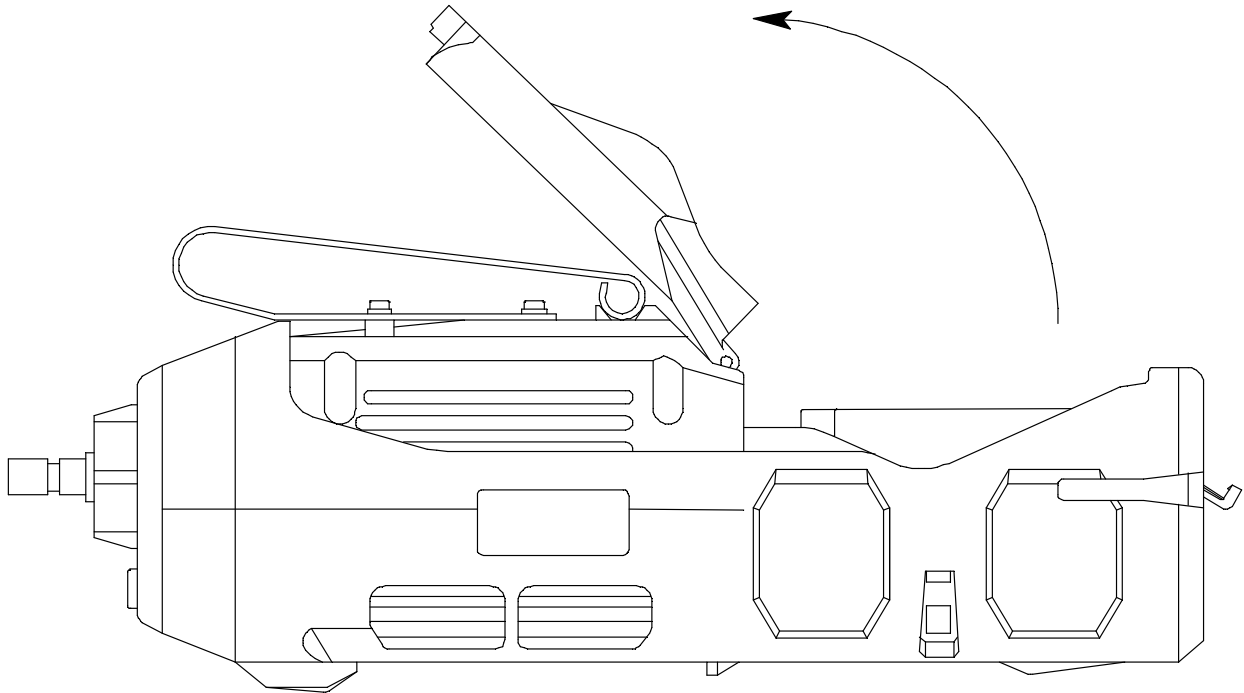
**WARNING:** *Do not remove the batteries while the GX-6000 is on.*

2. Turn the GX-6000 over so that the flow chamber and battery cover are facing up and the LCD is facing down.
3. Push the battery cover latch toward the bottom of the instrument.



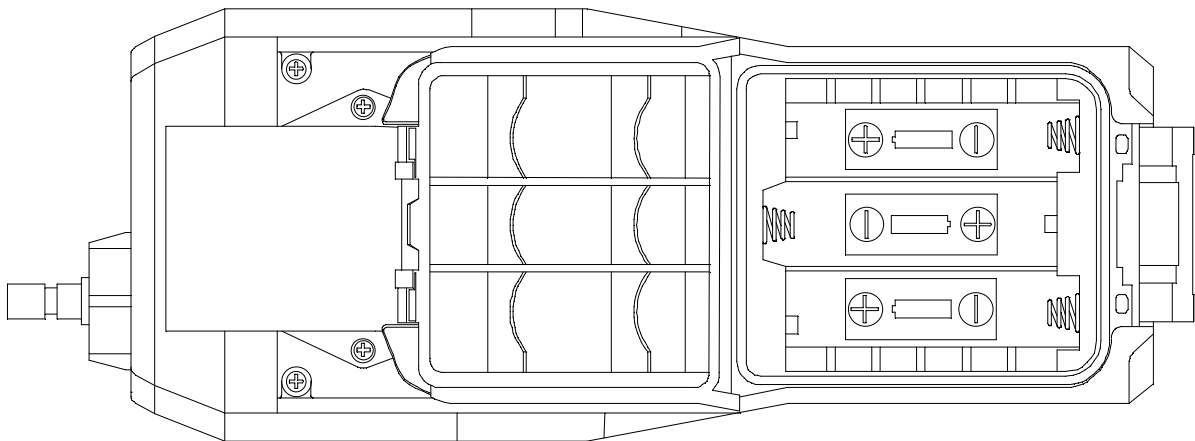
**Figure 11: Releasing Battery Cover Latch**

4. Grasp the end of the battery cover that's closest to the bottom of the instrument and lift it up.



**Figure 12: Opening Battery Cover**

5. Carefully remove the old alkaline batteries. Verify that the battery compartment and electrical contacts are clean.
6. Carefully install the new AA alkaline batteries according to the battery diagram inside the battery compartment.



**Figure 13: Installing the Alkaline Batteries**

7. Close the battery cover and secure the battery cover latch by pushing it up and toward the top of the instrument.

## Replacing the Lithium Ion Battery Pack

---

**NOTE:** Use Procell PC 1500 alkaline batteries or RKI Instruments, Inc. lithium-ion battery pack 49-1619 to maintain the CSA classification of the GX-6000. Use of other batteries will void the CSA classification and may void the warranty. Do not mix old/new or different types of batteries.

---

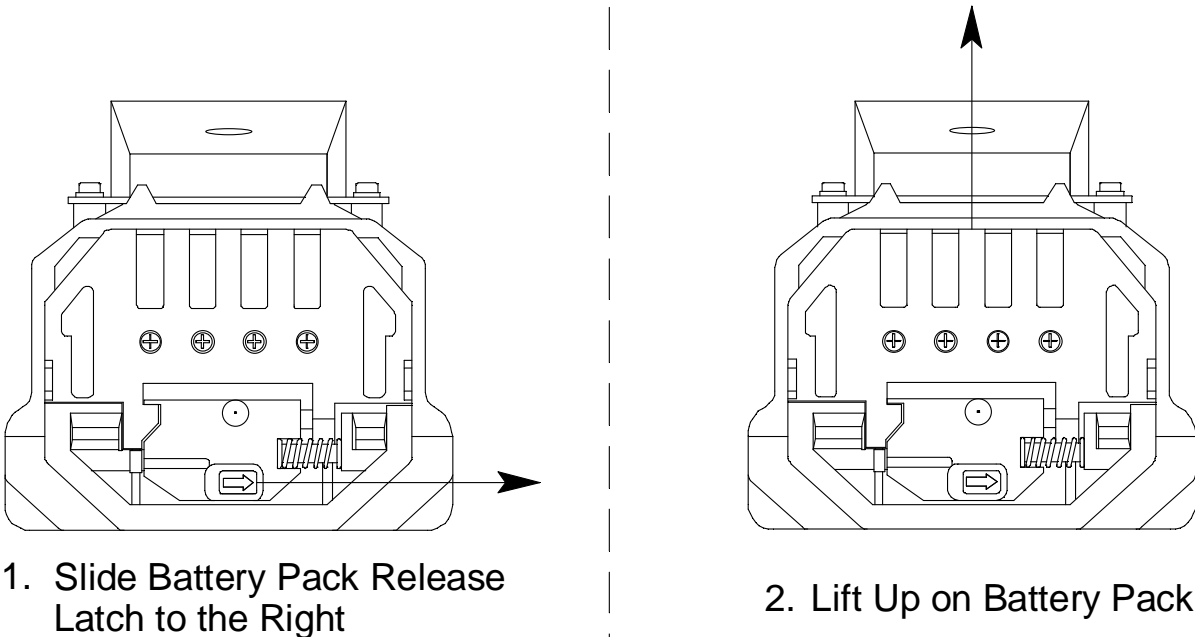
**NOTE:** Utiliser Procell 1500 piles alcalines ou RKI Instruments, Inc. pack batterie lithium-ion 49-1619 de maintenir la classification CSA de la GX-6000. L'utilisation d'autres piles annule la classification CSA et peut annuler la garantie. Ne mélangez pas les anciennes/nouvelles ou différents types de piles.

---

1. Turn off the GX-6000.

**WARNING:** *Do not remove the battery pack while the GX-6000 is on.*

2. Remove the rubber boot, if installed.
3. Turn the GX-6000 over so that the flow chamber and battery cover are facing up and the LCD is facing down.
4. The battery pack release latch is located on the bottom of the instrument and is closer to the front of the case than the back.
5. Slide the battery pack release latch to the right with one hand and lift up on the battery pack with the other.

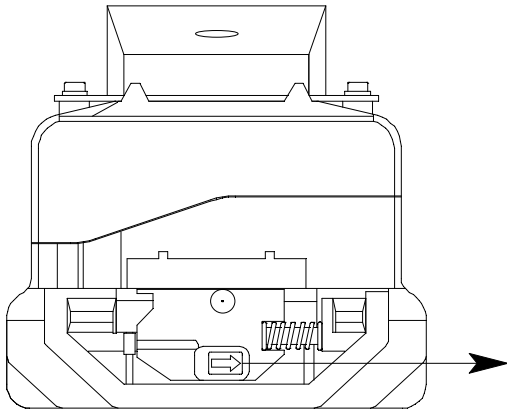


**Figure 14: Releasing the Battery Pack**

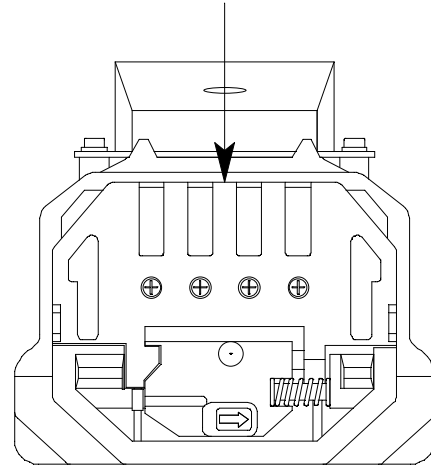
6. Slide the battery pack away from the instrument.



7. Install a new battery pack. If the battery pack release latch moved back into its closed position, slide the latch to the right with one hand and insert a new battery pack with the other.



1. Be Sure Battery Pack Release Latch is Pushed to the Right



2. Push New Battery Pack Down

**Figure 15: Installing the Battery Pack**

8. Release the battery pack release latch. If it does not return to its closed position automatically, push the latch to the left and toward the instrument until it is flush with the bottom of the instrument.
9. Reinstall the rubber boot, if desired.

### Recharging the Lithium Ion Battery Pack in the Instrument

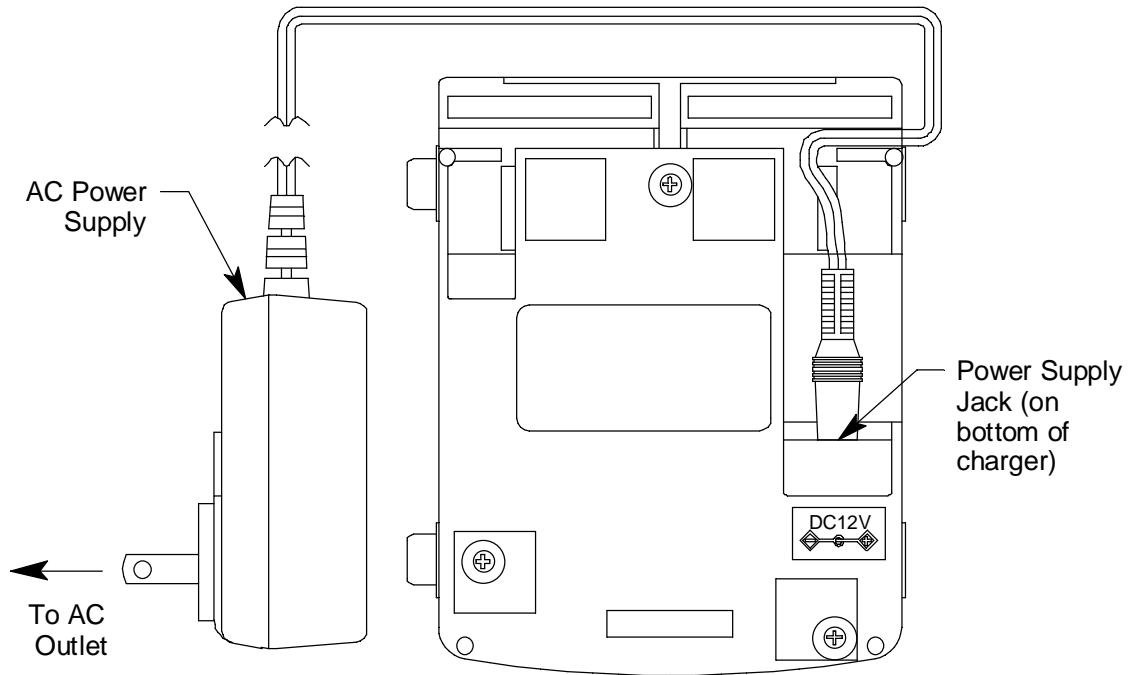
**CAUTION:** To be used only with lithium ion battery pack p/n 49-1619. Charge only with RKI charger model BC-6000, p/n 49-2182, or RKI charger model BC-6000DC, p/n 49-2183. Use of other rechargeable batteries or chargers or charging of other rechargeable batteries in the GX-6000 will void the warranty.

**PRUDENCE:** Pour être utilisé uniquement avec une batterie au lithium-ion p/n 49-1619. Charge uniquement en fonction du modèle de chargeur RKI BC-6000, p/n 49-2182, ou modèle de chargeur BC-6000DC RKI, p/n 49-2183. L'utilisation d'autres piles ou chargeurs rechargeables ou charger d'autres batteries rechargeables dans le GX-6000 annule la garantie.

The charger can be mounted to the wall using DIN rail, if desired. See “DIN Rail Mounting Assembly” on page 22 for instructions.

1. Make sure the GX-6000 is off.
2. Confirm that the power adapter's DC output cord is plugged into the charger.

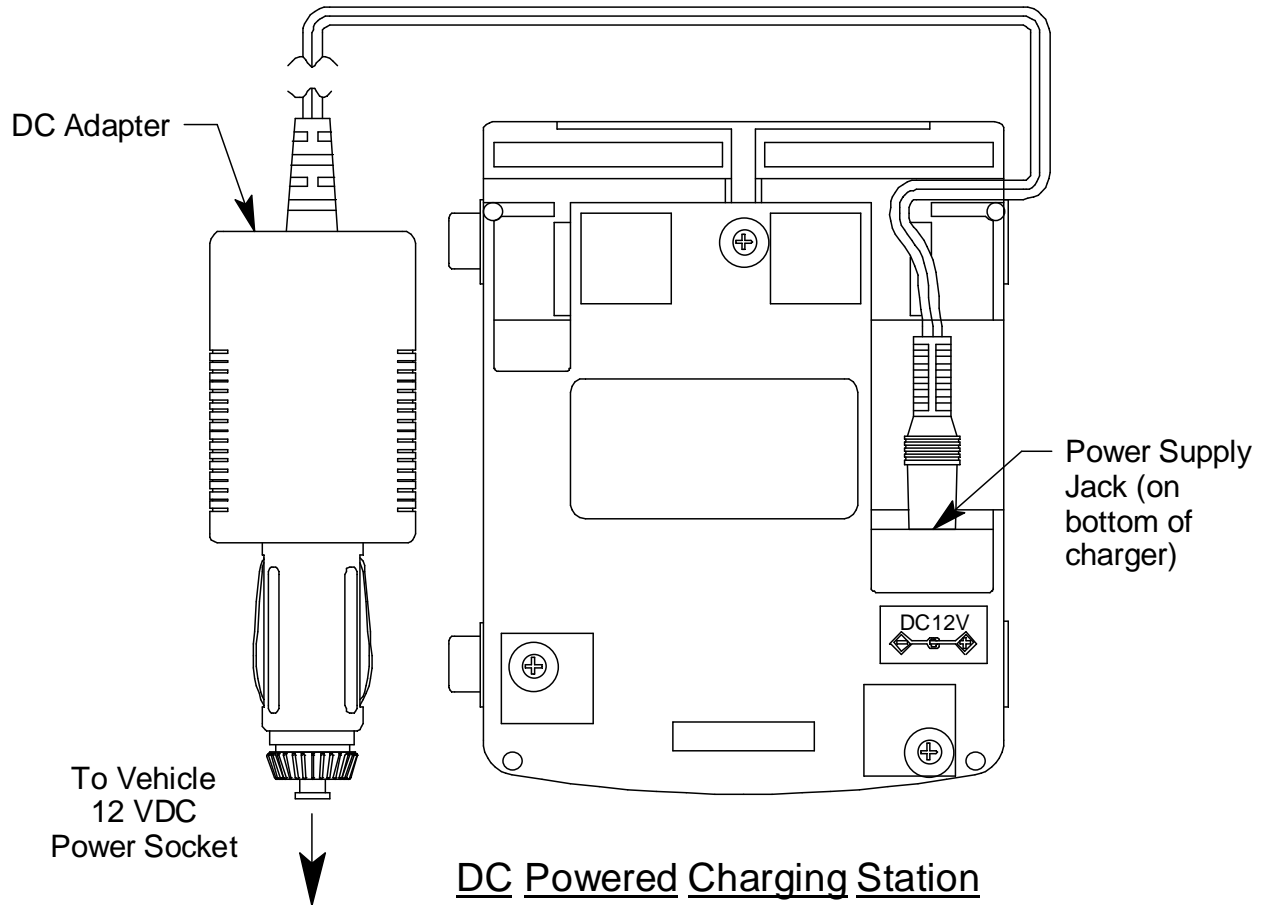
3. If using an AC powered charging station, plug the AC adapter into an electrical outlet.



### AC Powered Charging Station

**Figure 16: Connecting the Charging Station's AC Adapter**

If using a DC powered charging station, plug the 12 VDC vehicle plug adapter into a vehicle's 12 VDC power socket.

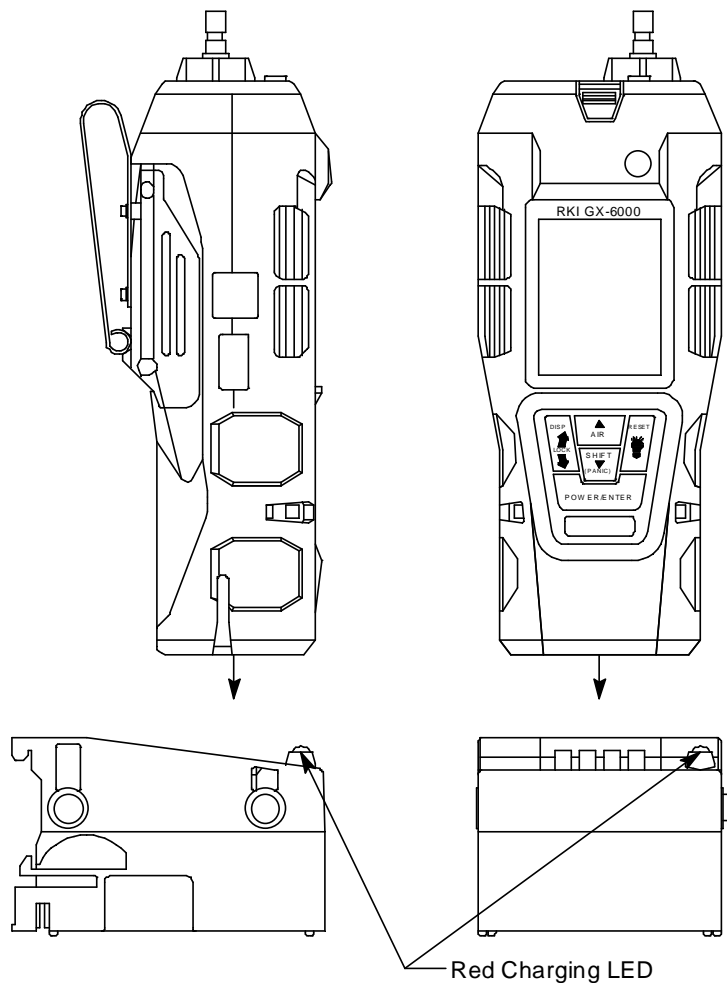


**Figure 17: Connecting the Charging Station's DC Adapter**

The construction of the charging stations allows them to be chained together but a separate adapter must be used for each charging station. One adapter will not operate more than one charging station.

4. Place the GX-6000 into the battery charging station as shown in Figure 18 below so that the metal contacts on the back of the unit come into contact with the metal contacts on the back of the holder in the charging station. When proper contact has been made, the red LED on the charging station will turn on.

If you are using a DC adapter, the charging station comes with a Velcro strap and washer assembly to secure the GX-6000. Ensure that the washer is installed over the GX-6000's inlet fitting, that both ends of the Velcro strap are attached to the charging station, and that the assembly is securing the instrument.



**Figure 18: Putting the GX-6000 into the Charging Station**

5. When a full charge has been reached, approximately 3 hours, the red LED on the charging station will turn off. Remove the GX-6000 from the charging station and unplug the charging station's power cord from the AC outlet.

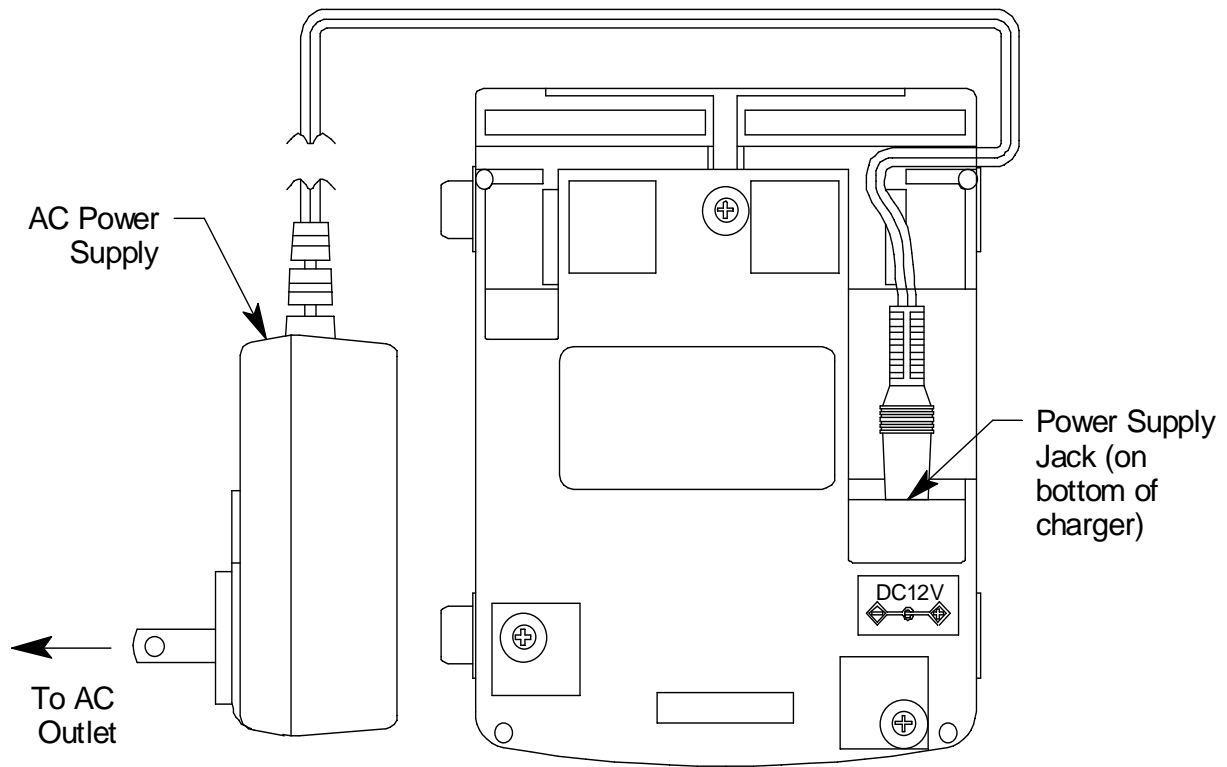
### **Recharging the Lithium Ion Battery Pack Out of the Instrument**

The lithium ion battery pack may be charged using the charging station while it is out of the GX-6000. This is useful if spare battery packs are kept in case the pack in the GX-6000 needs to be charged, but the unit must be used immediately. In this case, a spare charged pack can be installed in the GX-6000 and the dead pack charged in the charging station.

The charger can be mounted to the wall using DIN rail, if desired. See “DIN Rail Mounting Assembly” on page 22 for instructions.

1. Make sure the GX-6000 is off.
2. Confirm that the power adapter's DC output cord is plugged into the charger.

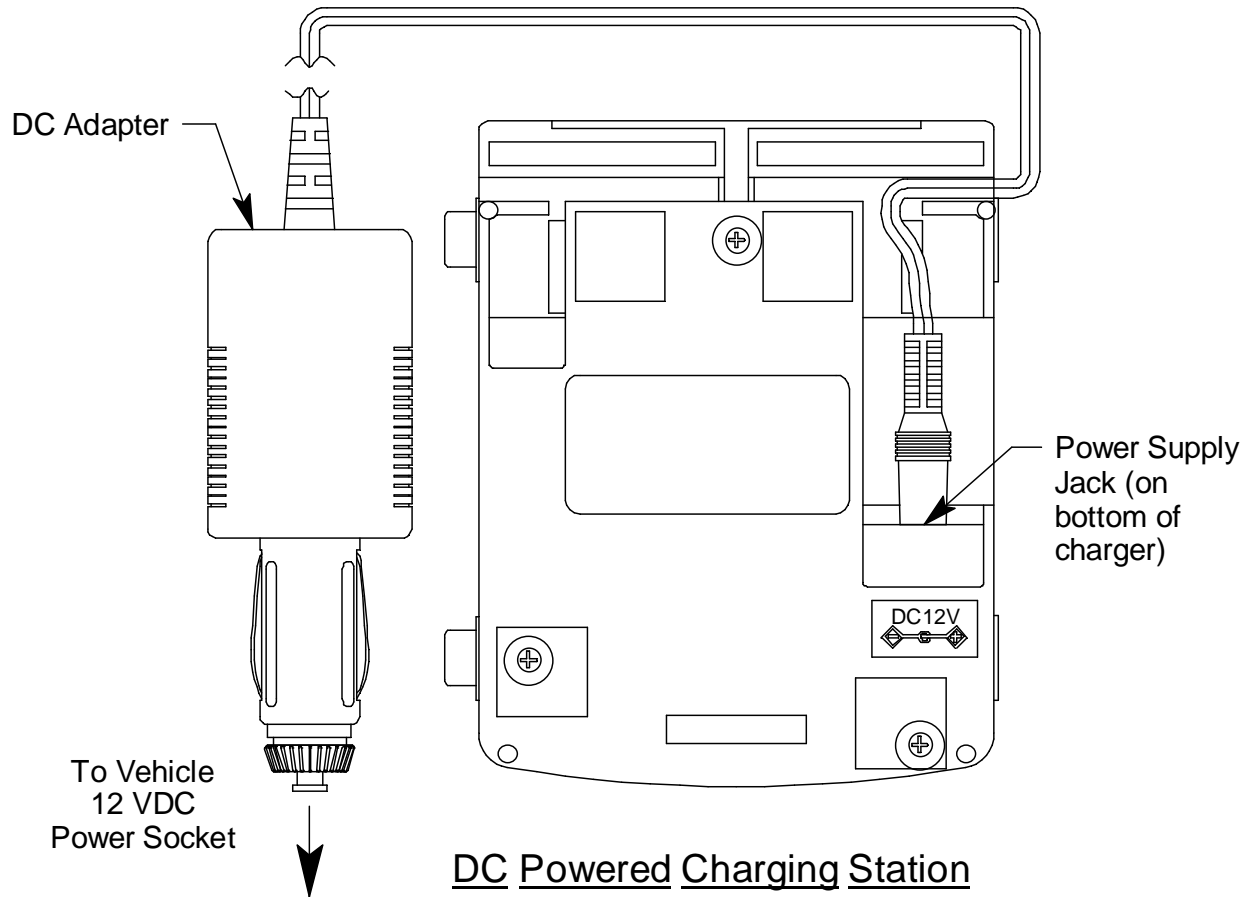
3. If using an AC powered charging station, plug the AC adapter into an electrical outlet.



### AC Powered Charging Station

**Figure 19: Connecting the Charging Station's AC Adapter**

If using a DC powered charging station, plug the 12 VDC vehicle plug adapter into a vehicle's 12 VDC power socket.

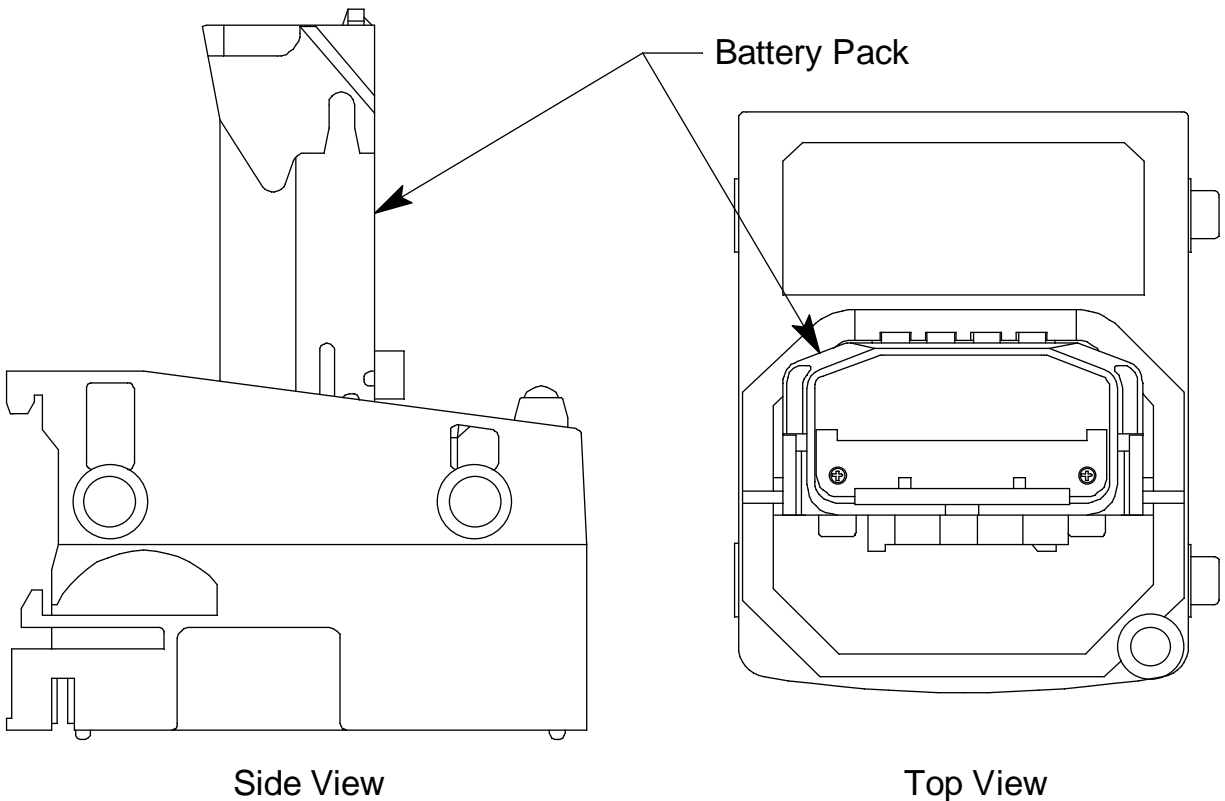


**Figure 20: Connecting the Charging Station's DC Adapter**

The construction of the charging stations allows them to be chained together but a separate adapter must be used for each charging station. One adapter will not operate more than one charging station.

4. If necessary, remove the battery pack from the instrument as described in Step 1 - Step 6 in "Replacing the Lithium Ion Battery Pack" on page 104.

5. Insert the battery pack into the charging station as shown in Figure 21 below so that the metal contacts on the back of the battery pack come into contact with the metal contacts in the charging station. When proper contact has been made, the red LED on the charging station will turn on.



**Figure 21: Putting the Battery Pack into the Charging Station**

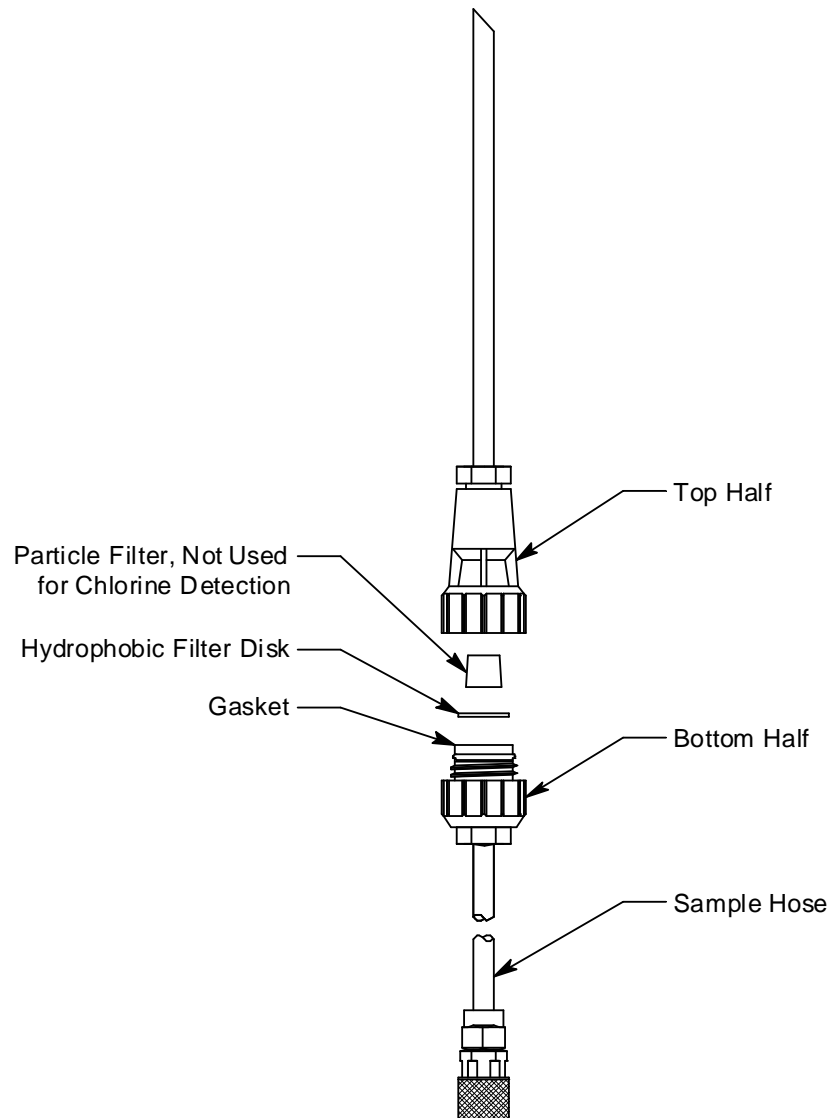
6. When a full charge has been reached, approximately 3 hours, the red LED on the charging station will turn off. Remove the battery pack from the charging station and unplug the charging station's power cord from the AC outlet.
7. If necessary, reinstall the battery pack as described in Step 7 - Step 8 of "Replacing the Lithium Ion Battery Pack" on page 104.

---

## Replacing the Probe's Particle Filter and Hydrophobic Filter Disk

Inspect the probe's internal components if you notice that the GX-6000's pump sounds bogged down or if an unexplained low flow alarm occurs. Replace the particle filter and hydrophobic filter disk if they appear dirty or saturated with liquid. Replace the gasket in the probe if it appears damaged.

1. Hold the sample hose and probe assembly so that the probe tip is pointing up.
2. Grasp each end of the clear probe body firmly and unscrew the two halves from each other. The top half includes the probe tube and the bottom half includes the sample hose.



**Figure 22: Replacing the Particle Filter and Hydrophobic Filter Disk**

3. Set the top half aside. Make sure the bottom half remains oriented with the sample hose facing down.
4. The particle filter should be sitting on top of the hydrophobic filter disk. If it is not, remove it from the top half of the probe.



5. Remove the white hydrophobic filter disk from the top of the bottom half. The disk sits in a black gasket.
6. Place the new filter disk flat on top of the gasket. Make sure that it sits in the gasket and does not extend over the gasket's edge.
7. Set the new particle filter on top of the filter disk. The bigger end should be facing down.

**CAUTION:** *If you are replacing filters in a probe intended for chlorine detection, do not install the particle filter.*

8. Carefully screw the top half onto the bottom half disk while keeping the probe oriented with the probe tip facing up and the sample hose facing down. The particle filter fits into a recess in the top half of the probe. Be sure the particle filter is not compressed in any way.
9. Tighten the halves together very firmly to ensure a seal.
10. To test the seal, do the following.
  - a. Install the probe on the GX-6000.
  - b. Startup the GX-6000.
  - c. Confirm that a low flow alarm occurs when you cover the end of the probe tube with your finger.
  - d. If a low flow alarm does not occur, hand tighten the probe further.
  - e. If a low flow alarm still does not occur when you cover the probe tube with your finger, disassemble the probe, inspect the placement of the hydrophobic filter disk, reassemble the probe, and re-test it.

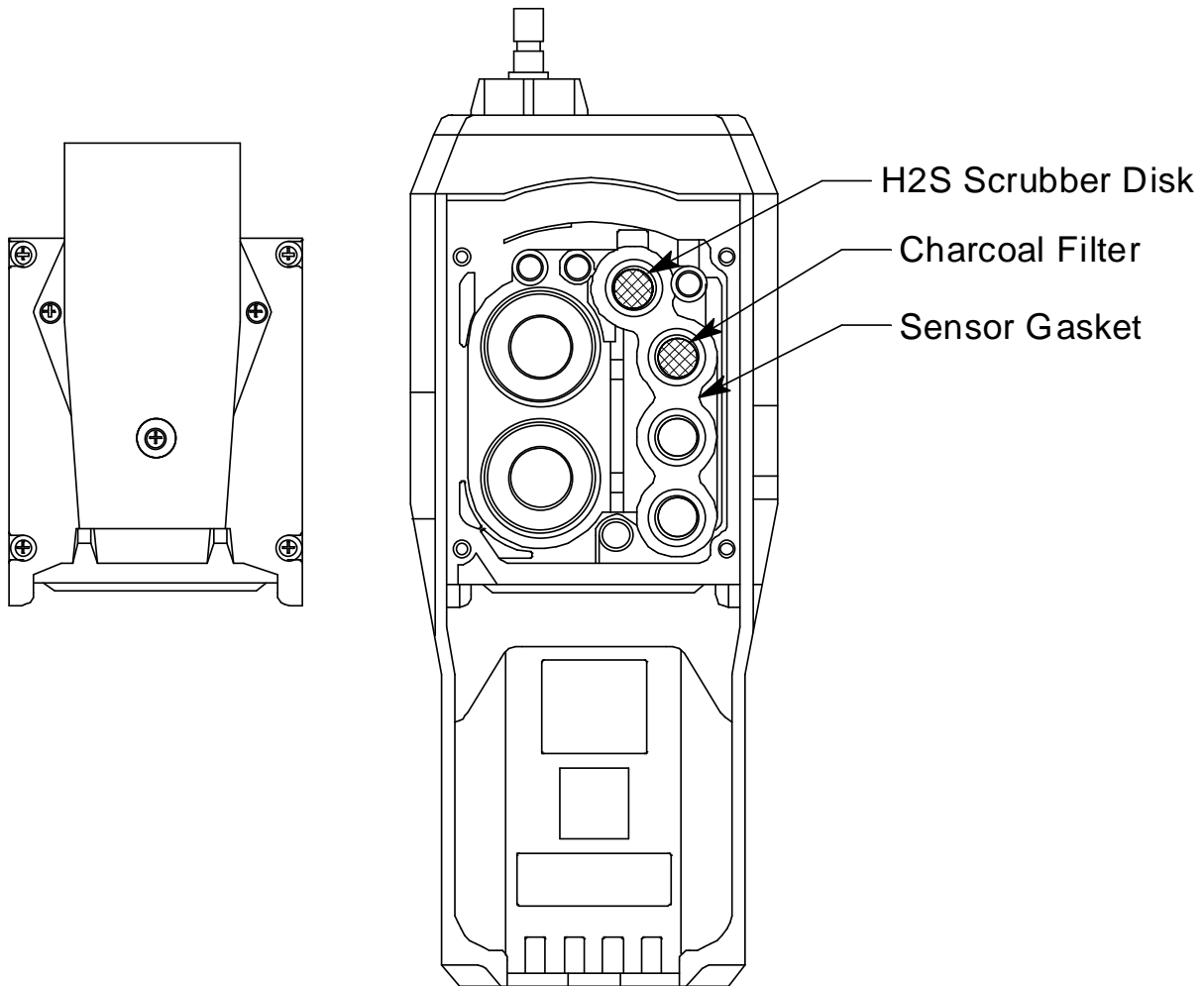
---

## Replacing the H<sub>2</sub>S Scrubber Disk and the Charcoal Filter

The H<sub>2</sub>S filter disk is dark red in color and although it may darken over time, its color is not indicative of remaining filter life. The H<sub>2</sub>S filter disk can absorb H<sub>2</sub>S for 33 ppm hours and should be replaced after that much exposure. With this many ppm hours of absorption, the H<sub>2</sub>S filter disk should be replaced after 80 minutes of exposure to 25 ppm H<sub>2</sub>S. This equates to replacing the H<sub>2</sub>S filter disk after 40 2-minute calibrations with a cylinder containing 25 ppm H<sub>2</sub>S. If H<sub>2</sub>S exists in the monitoring environment, the H<sub>2</sub>S filter disk will have to be replaced more frequently.

1. Verify that the GX-6000 is off.
2. Use a small Phillips screwdriver to unscrew the four screws holding the flow chamber to the rest of the GX-6000's case.
3. Grasp the sides of the flow chamber and lift it away from the rest of the case. The screws are captive screws and will not come out of the flow chamber.
4. To replace the H<sub>2</sub>S scrubber disk, remove the old one from its recess in the sensor gasket and replace it with the new one making sure that it is properly seated. You do not have to remove the sensor gasket to replace the H<sub>2</sub>S scrubber disk. It sits in a recess on top of it.

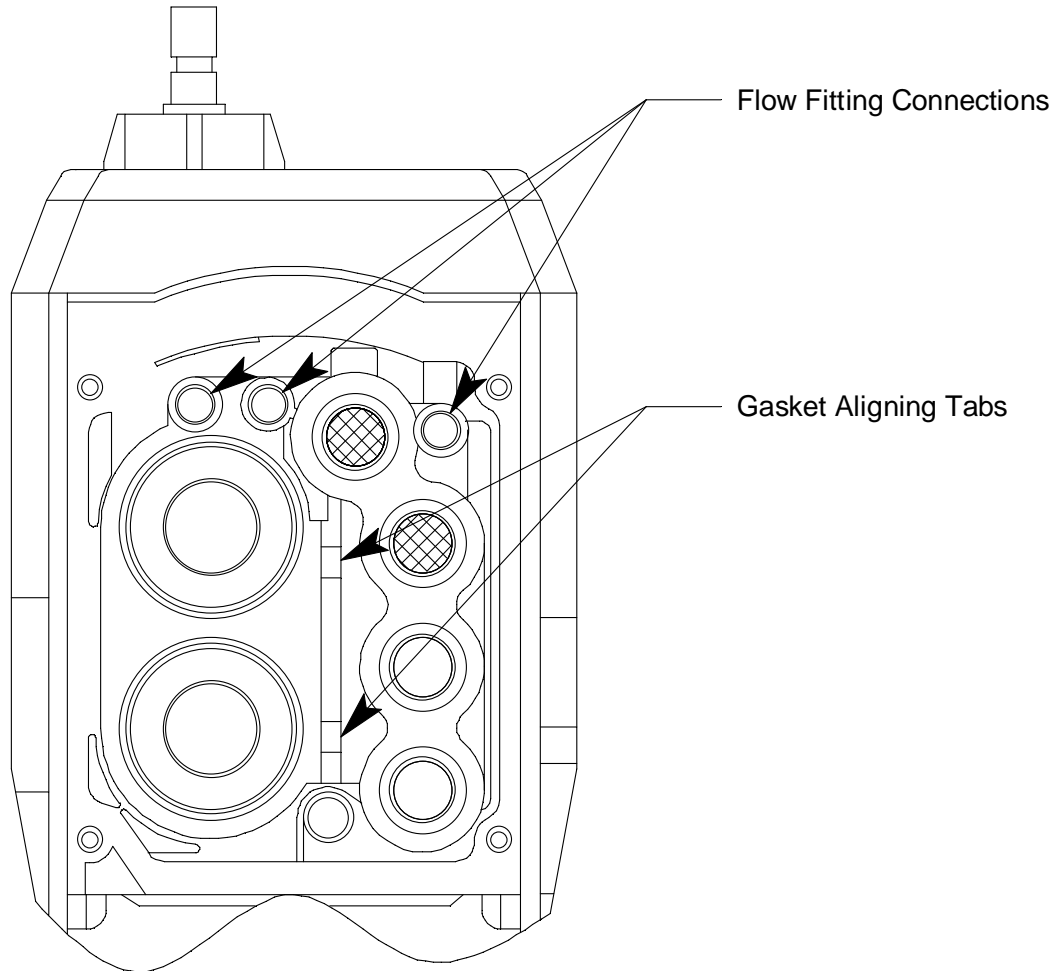
5. To replace the charcoal filter, pull the old one out of its recess in the sensor gasket if it did not already come out and replace it with a new one. You do not have to remove the sensor gasket to do this. The charcoal filter sits in a recess on top of it.



**Figure 23: Replacing the H<sub>2</sub>S Scrubber Disk and Charcoal Filter**

6. Ensure that the sensor gasket is installed properly. The flow fitting connections need to be facing up and cannot be skewed sideways. The gasket must be pushed down in the center and secured under the gasket aligning tabs.

**Failure to install the sensor gasket appropriately may result in inaccurate gas readings.**



**Figure 24: Sensor Gasket Seating**

7. Insert the flow chamber back into the instrument.
8. Tighten the flow chamber's four screws that were loosened in Step 2.
9. To verify that the sensor gasket was inserted properly:
  - a. Turn the GX-6000 on.
  - b. Plug the inlet with your finger.
  - c. Verify that the GX-6000 goes into low flow alarm. If the GX-6000 does not go into low flow alarm, turn the instrument off and attempt to seat the sensor gasket again.

---

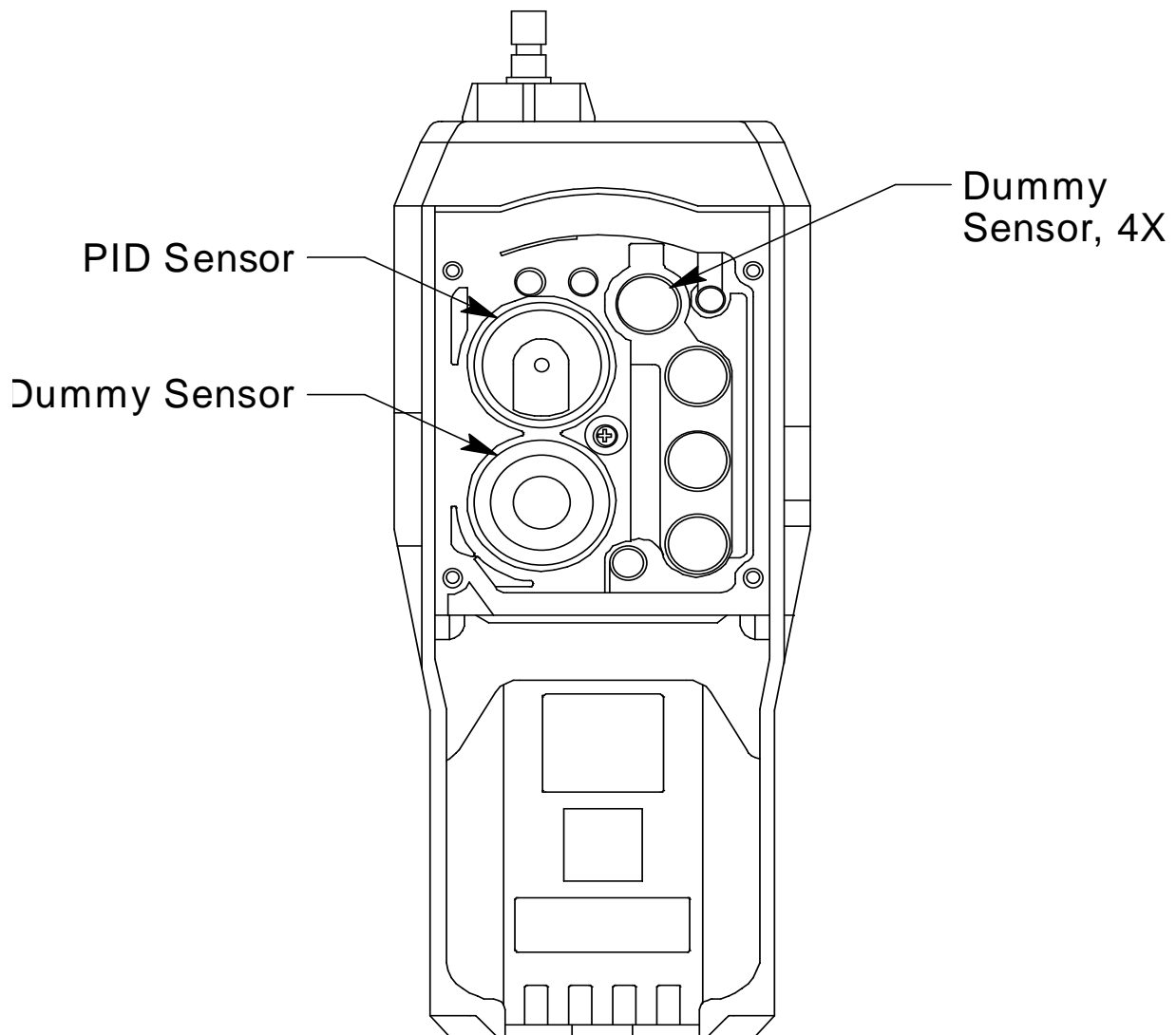
## Replacing a Sensor

1. Verify that the GX-6000 is off.
2. Use a small Phillips screwdriver to unscrew the four screws holding the flow chamber to the rest of the GX-6000's case.
3. Grasp the sides of the flow chamber and lift it away from the rest of the case. The screws are captive screws and will not come out of the flow chamber.
4. Gently pull up the edges of the sensor gasket to loosen it from its connections. Be sure not to lose any of the filters that are in it. The sensors will be exposed.
5. Locate the sensor you want to replace and remove it from its socket.
6. Carefully insert the replacement sensor in the correct socket.
  - a. Be sure that the new sensor is installed in the same position as the old sensor and that the following sensor priority for the smart sensor 1 position is maintained.

**Table 14: Priority for Smart Sensor 1 Position**

High Priority ↓ Low Priority	10.6 eV low range PID
	10.0 eV/benzene PID
	11.7 eV PID
	10.6 eV high range PID
	ESS-03 Chlorine
	ESS-03 Ammonia
	IR and other ESS-03 sensors

For example, if your instrument is a 4-gas + low range PID + high range PID, the low range PID sensor should be in the smart sensor 1 position and the high range PID sensor should be in the smart sensor 2 position. If your instrument is a 4-gas + high range PID, the high range PID sensor should be in the smart sensor 1 position and a dummy sensor should be installed in the smart sensor 2 position. See the figure below for the location of the smart sensor 1 and 2 positions.



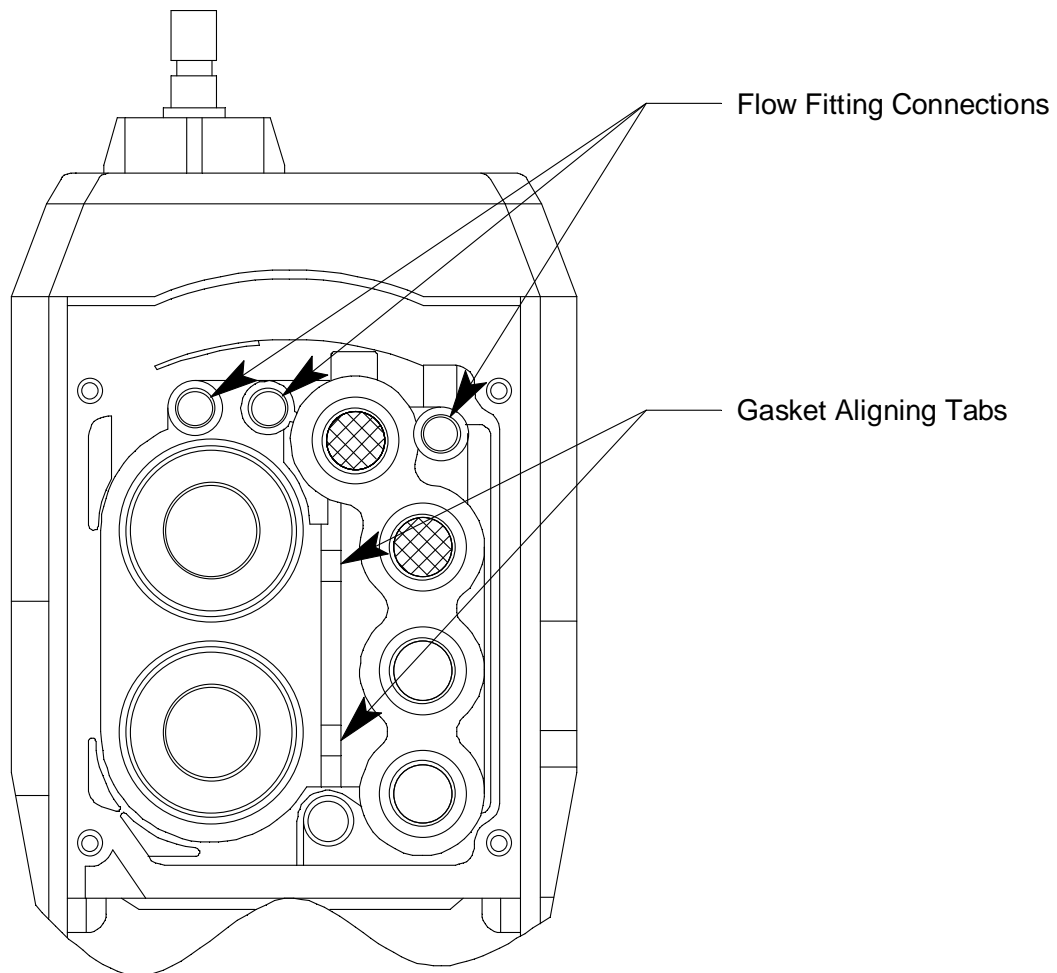
**Figure 25: Replacing a Sensor**

**CAUTION:** *When replacing a sensor, verify that the sensor is properly aligned with its socket before inserting it into the socket. The CO and H<sub>2</sub>S sensors have alignment slots which match up with alignment tabs in the sockets. The combustible sensors each have two non-polarized contacts which must line up with the contacts in their socket. Forcing a sensor into its socket may damage the sensor or the socket.*

7. If your instrument has a factory installed dummy sensor, ensure that it is still installed correctly. Make sure that the flat side is up and the hollow side is down.

- 8 . Place the sensor gasket and filters back over the sensors ensuring that the sensor gasket seals with the sensors and the flow fittings. The flow fitting connections need to be facing up and cannot be skewed sideways. The gasket must be pushed down in the center and secured under the gasket aligning tabs.

**Failure to install the sensor gasket appropriately may result in inaccurate gas readings.**



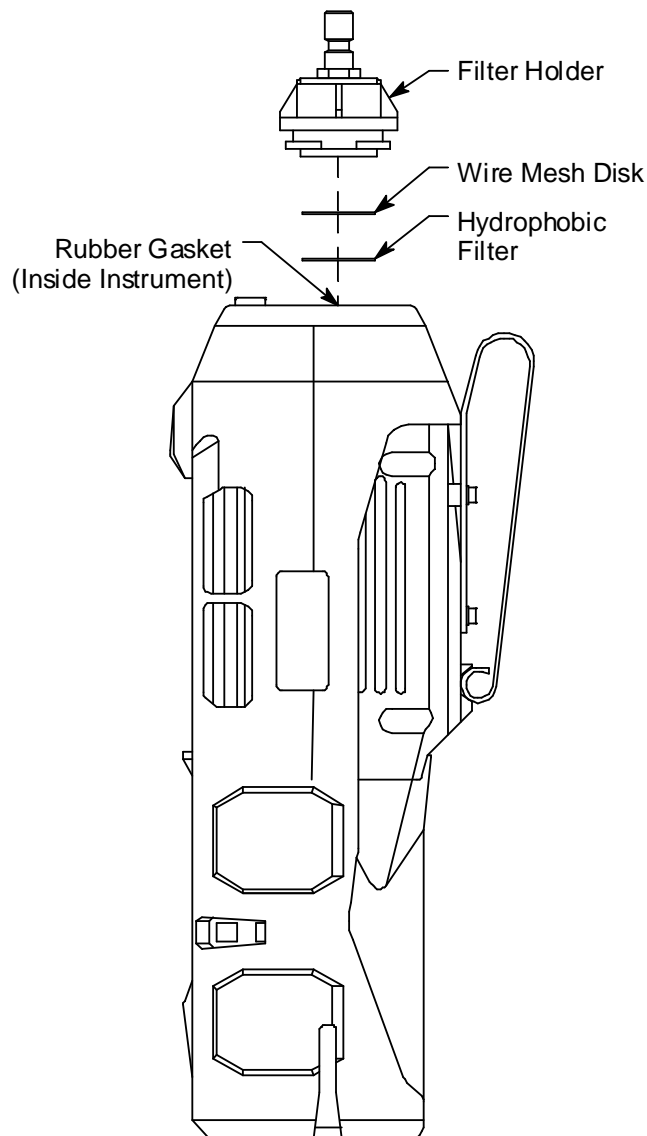
**Figure 26: Sensor Gasket Seating**

- 9 . Insert the flow chamber back into the instrument.
- 10 . Tighten the flow chamber's four screws that were loosened in Step 2.
- 11 . Start up the GX-6000 by pressing and briefly holding the POWER/ENTER button.
- 12 . To verify that the sensor gasket was inserted properly:
  - a. Plug the inlet with your finger.
  - b. Verify that the GX-6000 goes into low flow alarm. If the GX-6000 does not go into low flow alarm, turn the instrument off and attempt to seat the sensor gasket again.
- 13 . Calibrate the new sensors as described in "Chapter 4: Calibration Mode" on page 70.

---

## Replacing the Hydrophobic Filter and Wire Mesh Disk

1. Verify that the GX-6000 is off.
2. Locate the clear plastic filter holder at the top of the GX-6000.
3. Grasp the filter holder and turn it 1/4 turn counterclockwise.
4. Pull the filter holder away from the case.
5. The wire mesh disk and hydrophobic filter are located in the case and are retained by a rubber gasket.



**Figure 27: Changing the Filter & Wire Mesh Disk**

6. Using a small flat head screwdriver, carefully pry the wire mesh disk and hydrophobic filter from the gasket. Do not remove the gasket.
7. Carefully install the new hydrophobic filter and/or wire mesh disk making sure the wire mesh disk is on top of the hydrophobic filter.

8. Reinstall the filter holder. Align the two wide tabs on the bottom of the filter holder with the two wide slots in the case where the filter holder fits. Push the filter holder into the case and turn it 1/4 turn clockwise until it snaps into place.

---

## PID Sensor Maintenance

The PID sensor includes user serviceable parts. They are the lamp and the electrode stack. The following sections include procedures for cleaning the lamp, replacing the lamp, and replacing the electrode stack.

### Cleaning the PID Sensor's Lamp

Clean the lamp if you notice a significant drop in sensitivity from one scheduled calibration to another or if you are not able to calibrate the PID channel. See the Table 16 on page 131 for lamp cleaning kit ordering information. The lamp cleaning kit includes the following items:

- an electrode stack removal tool
- a small vial of aluminum oxide powder
- 40 cotton swabs
- 10 finger cots

Perform the following procedure to clean the PID lamp:

1. Verify that the GX-6000 is off.
2. Use a small Phillips screwdriver to unscrew the four screws holding the flow chamber to the rest of the GX-6000's case.
3. Grasp the sides of the flow chamber and lift it away from the rest of the case. The screws are captive screws and will not come out of the flow chamber.
4. Gently pull up the edges of the sensor gasket to loosen it from its connections. Be sure not to lose any of the filters that are in it. The sensors will be exposed.
5. Locate the PID sensor.
6. Grasp the sensor firmly and pull it out of its socket.
7. Place the PID sensor face down on a flat clean working surface.

---

**NOTE:** Do not touch the lamp window with your fingers as this may contaminate the window with finger oil. At this point it is recommended that the finger cots be used on the fingers handling the lamp. Finger cots are included with the lamp cleaning kit.

---

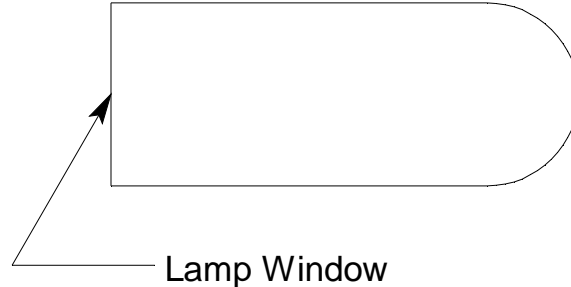


- 8 . Hold the PID sensor steady on the working surface with one hand and using the other hand, locate the tabs on the electrode stack removal tool and insert them into the slots on the side of the PID sensor near the face.



**Figure 28: Using Removal Tool**

- 9 . Squeeze the removal tool to push the tabs into the sensor slots until the electrode stack and lamp are released.
- 10 . Carefully lift the PID sensor body away from the electrode stack and lamp. Take care not to touch the lamp window, the flat end of the lamp, with your fingers. If the lamp remains lodged in the sensor body, carefully remove it with tweezers.



**Figure 29: Lamp Window Location**

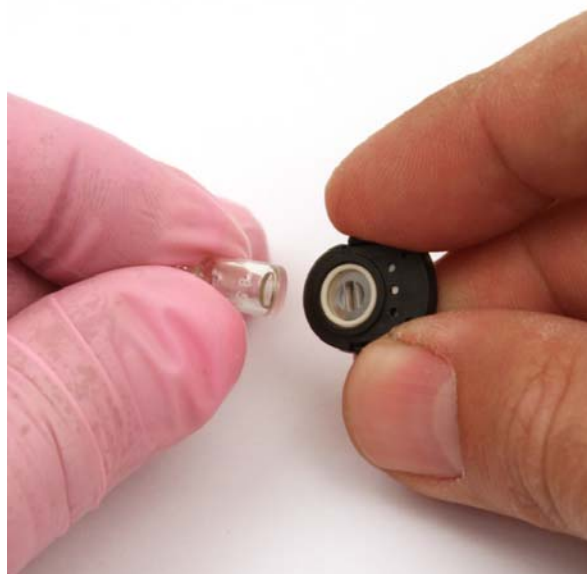
- 11 . If the spring in the lamp cavity comes out, place it back into the lamp cavity.
- 12 . Hold the lamp in one hand being careful not to touch the lamp window with your fingers.
- 13 . With the other hand collect a small amount of aluminum oxide powder on a cotton swab.

- 14 . Use this cotton swab to polish the PID lamp window. Use a circular motion, applying light pressure to clean the lamp window. Do not touch the lamp window with your fingers.



**Figure 30: Polishing the Electrode Lamp Window**

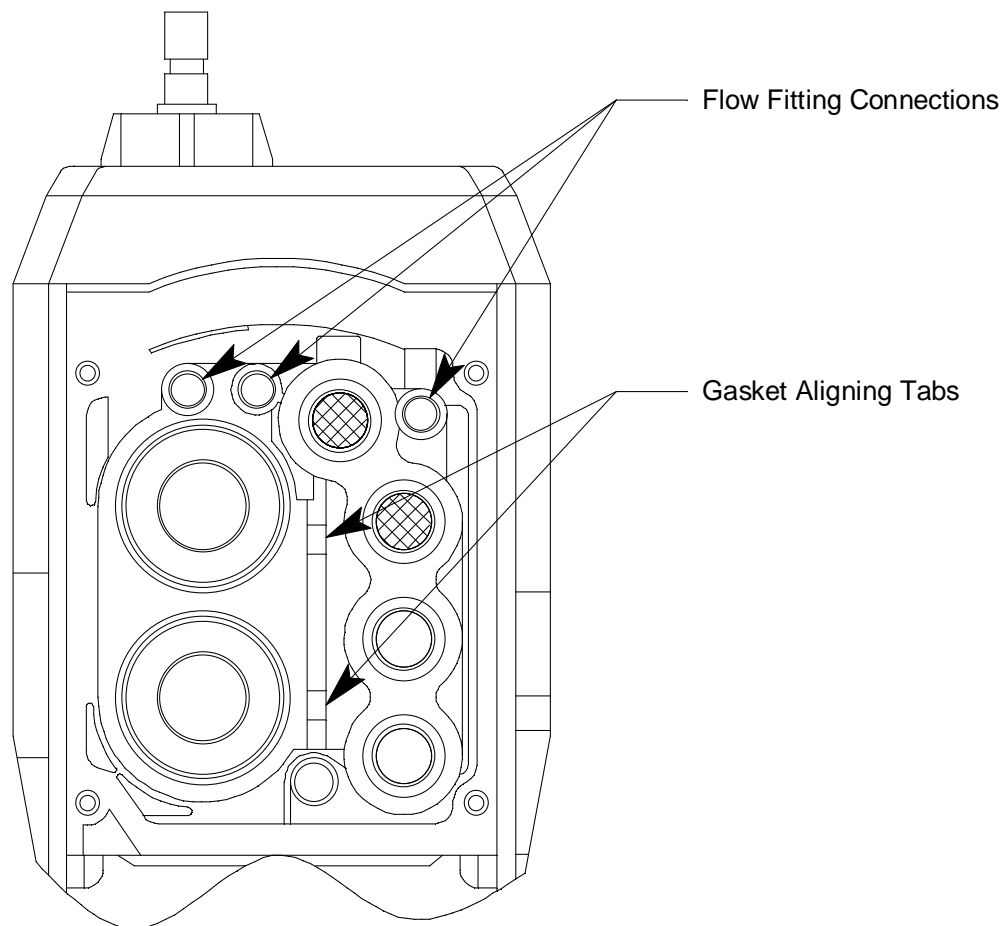
- 15 . Continue polishing until you can hear a squeaking sound made by the cotton swab moving over the window surface. This usually occurs after about 15 seconds of polishing.
- 16 . Remove the residual powder from the lamp window with a clean cotton swab. Take care not to touch the tip of the cotton swab that is used to clean the lamp as this may contaminate it with finger oil.
- 17 . Ensure the lamp is completely dry and any visible signs of contamination are removed before reinstalling.
- 18 . Hold the electrode stack between the thumb and forefinger of one hand and place the window end of the lamp inside the O-ring seal in the electrode stack with the other hand as shown below.



**Figure 31: Reinstalling the Electrode Lamp**

- 19 . Twisting the lamp slightly during insertion will help to ensure the lamp window is snug against the stack's front electrode. The lamp should be supported by the O-ring.
- 20 . Continuing to hold the electrode stack between your forefinger and thumb, carefully insert the lamp into the lamp cavity in the sensor ensuring that the lamp remains in position.
- 21 . Press in the electrode stack firmly to ensure that the stack wing clips are engaged and the faces of the stack and sensor body are flush.
- 22 . Carefully line up the PID sensor's connections with the connections on the bottom of the socket and slowly insert the sensor in the socket.
- 23 . Do not attempt to push the sensor in farther once it makes contact with the bottom of the socket until you are sure that the sensor's connections are engaged with the socket's connections. If you feel that the connections did not engage, slightly rotate the sensor back and forth without putting pressure on it until you feel the connections engage.
- 24 . Push the sensor into the socket until it bottoms out.
- 25 . Place the sensor gasket and filters back over the sensors ensuring that it seals with the sensors and the flow fittings. The flow fitting connections need to be facing up and cannot be skewed sideways. The gasket must be pushed down in the center and secured under the gasket aligning tabs.

**Failure to install the sensor gasket appropriately may result in inaccurate gas readings.**



**Figure 32: Sensor Gasket Seating**

- 26 . Insert the flow chamber back into the instrument.
- 27 . Tighten the flow chamber's four screws that were loosened in Step 2.
- 28 . Start up the GX-6000 by pressing and briefly holding the POWER/ENTER button.
- 29 . To verify that the sensor gasket was inserted properly:
  - a. Plug the inlet with your finger.
  - b. Verify that the GX-6000 goes into low flow alarm. If the GX-6000 does not go into low flow alarm, turn the instrument off and attempt to seat the sensor gasket again.
- 30 . Calibrate the PID sensor as described in "Chapter 4: Calibration Mode" on page 70.

## Replacing the PID Sensor's Lamp

If cleaning the PID lamp does not resolve any calibration problems you may be having, the lamp may need to be replaced.

### ***Ordering the Correct Replacement Lamp***

It's important to order the correct replacement lamp for your PID sensor.

- 1 . Look at the label(s) on the side of your PID sensor. Some sensors only have a label that says "PIS-001" or "PIS-002". Other sensors have a label that says "PIS-001" or "PIS-002" and another RKI part number label that says "PID-001L" or "PID-002L".
- 2 . See the table below for replacement lamp part numbers based on your sensor's label(s).

**Table 15: PID Sensor Replacement Lamp Part Number**

Sensor Part Number	Part Number Label(s) on Sensor	Replacement Lamp Part Number
PID-001	PIS-001	51-1500RK
PID-001L	PIS-001 <u>and</u> PID-001L	51-1503
PID-002	PIS-002	51-1502
PID-002L	PIS-002 <u>and</u> PID-002L	51-1503

### ***Steps to Replace the Lamp***

Perform the following procedure to replace the PID lamp:

---

**NOTE:** Do not touch the new lamp window (the flat end) with your fingers as this may contaminate the window with finger oil.

---

- 1 . Verify that the GX-6000 is off.
- 2 . Use a small Phillips screwdriver to unscrew the four screws holding the flow chamber to the rest of the GX-6000's case.
- 3 . Grasp the sides of the flow chamber and lift it away from the rest of the case. The screws are captive screws and will not come out of the flow chamber.
- 4 . Gently pull up the edges of the sensor gasket to loosen it from its connections. Be sure not to lose any of the filters that are in it. The sensors will be exposed.

- 5 . Locate the PID sensor.
- 6 . Grasp the sensor firmly and pull it out of its socket.
- 7 . Place the PID sensor face down on a flat clean working surface.
- 8 . Hold the PID sensor steady on the working surface with one hand and using the other hand, locate the tabs on the electrode stack removal tool and insert them into the slots on the side of the PID sensor near the face.



**Figure 33: Using Removal Tool**

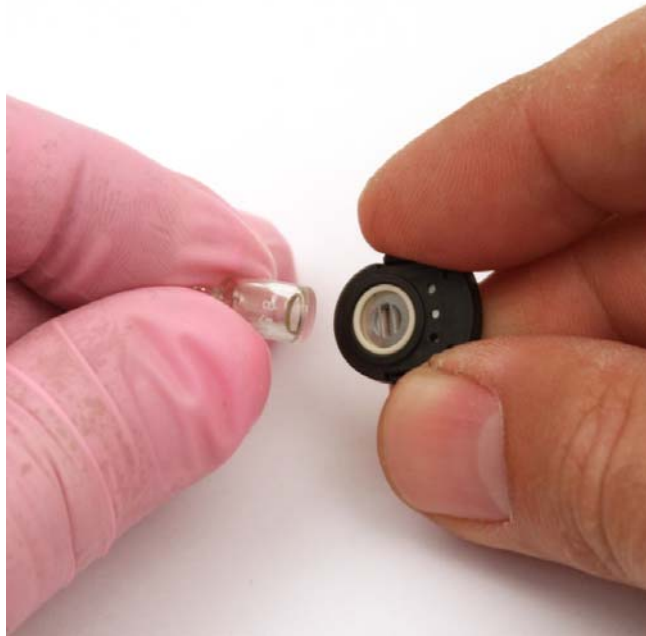
- 9 . Squeeze the removal tool to push the tabs into the sensor slots until the electrode stack and lamp are released.
- 10 . Carefully lift the PID sensor body away from the electrode stack and lamp. If the lamp remains lodged in the sensor body, carefully remove it with tweezers.
- 11 . If the spring in the lamp cavity comes out, place it back into the lamp cavity.
- 12 . Discard the old PID lamp.

---

**NOTE:** At this point it is recommended that the finger cots be used on the fingers handling the lamp. Finger cots are included with the lamp cleaning kit.

---

- 13 . Hold the electrode stack between the thumb and forefinger of one hand and place the window end of the new lamp inside the O-ring seal in the electrode stack with the other hand as shown below. Take care not to touch the lamp window.

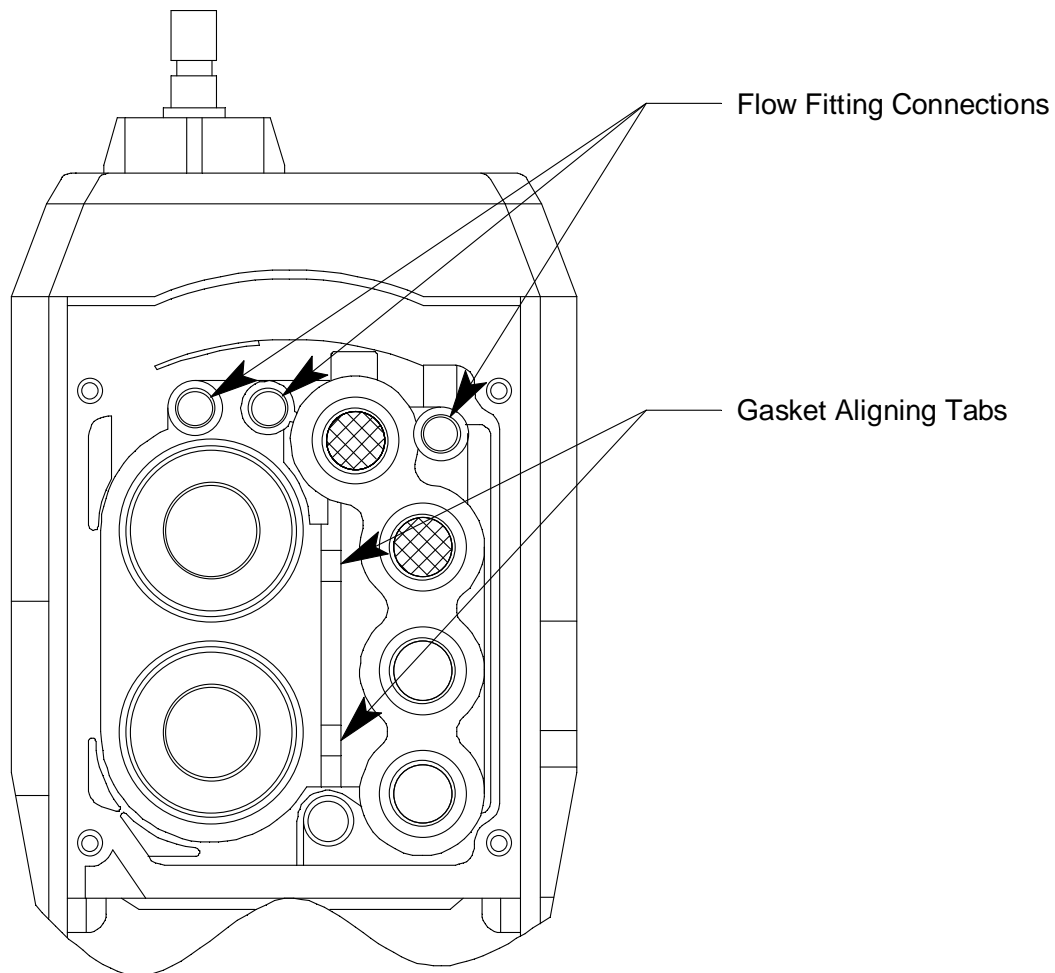


**Figure 34: Reinstalling the Electrode Lamp**

- 14 . Twisting the lamp slightly during insertion will help to ensure the lamp window is snug against the stack's front electrode. The lamp should be supported by the O-ring.
- 15 . Continuing to hold the electrode stack between your forefinger and thumb, carefully insert the lamp into the lamp cavity in the sensor ensuring that the lamp remains in position.
- 16 . Press in the electrode stack firmly to ensure that the stack wing clips are engaged and the faces of the stack and sensor body are flush.
- 17 . Carefully line up the PID sensor's connections with the connections on the bottom of the socket and slowly insert the sensor in the socket.
- 18 . Do not attempt to push the sensor in farther once it makes contact with the bottom of the socket until you are sure that the sensor's connections are engaged with the socket's connections. If you feel that the connections did not engage, slightly rotate the sensor back and forth without putting pressure on it until you feel the connections engage.
- 19 . Push the sensor into the socket until it bottoms out.

- 20 . Place the sensor gasket and filters back over the sensors ensuring that it seals with the sensors and the flow fittings. The flow fitting connections need to be facing up and cannot be skewed sideways. The gasket must be pushed down in the center and secured under the gasket aligning tabs.

**Failure to install the sensor gasket appropriately may result in inaccurate gas readings.**



**Figure 35: Sensor Gasket Seating**

- 21 . Insert the flow chamber back into the instrument.
- 22 . Tighten the flow chamber's four screws that were loosened in Step 2.
- 23 . Start up the GX-6000 by pressing and briefly holding the POWER/ENTER button.
- 24 . To verify that the sensor gasket was inserted properly:
  - a. Plug the inlet with your finger.
  - b. Verify that the GX-6000 goes into low flow alarm. If the GX-6000 does not go into low flow alarm, turn the instrument off and attempt to seat the sensor gasket again.
- 25 . Calibrate the PID sensor as described in "Chapter 4: Calibration Mode" on page 70.

## Replacing the PID Sensor's Electrode Stack

The electrode stack can last for the life of the PID sensor if the GX-6000 is used in a very clean, controlled environment. When used in a heavily contaminated or dirty environment, the electrode stack may only last a month. A contaminated electrode stack will cause a drop in sensitivity which can cause problems calibrating the PID channel. The electrode stack should be replaced if the PID sensor shows signs of contamination even after cleaning or replacing the lamp.

---

**NOTE:** Do not touch the new lamp window (the flat end) with your fingers as this may contaminate the window with finger oil.

---

1. Verify that the GX-6000 is off.
2. Use a small Phillips screwdriver to unscrew the four screws holding the flow chamber to the rest of the GX-6000's case.
3. Grasp the sides of the flow chamber and lift it away from the rest of the case. The screws are captive screws and will not come out of the flow chamber.
4. Gently pull up the edges of the sensor gasket to loosen it from its connections. Be sure not to lose any of the filters that are in it. The sensors will be exposed.
5. Locate the PID sensor.
6. Grasp the sensor firmly and pull it out of its socket.
7. Place the PID sensor face down on a flat clean working surface.

---

**NOTE:** At this point it is recommended that the finger cots be used on the fingers handling the lamp. Finger cots are included with the lamp cleaning kit.

---

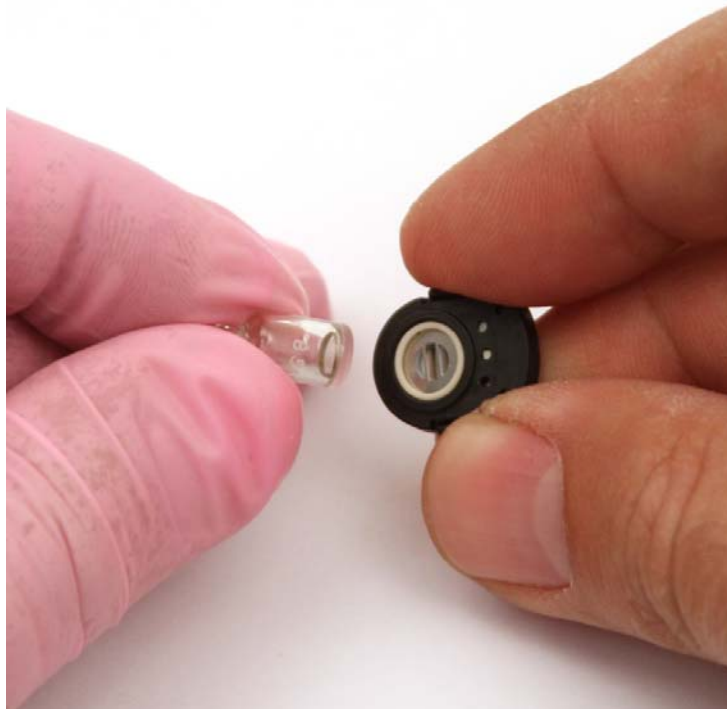
8. Hold the PID sensor steady on the working surface with one hand and using the other hand, locate the tabs on the electrode stack removal tool and insert them into the slots on the side of the PID sensor near the face.



**Figure 36: Using Removal Tool**



- 9 . Squeeze the removal tool to push the tabs into the sensor slots until the electrode stack and lamp are released.
- 10 . Carefully lift the PID sensor body away from the electrode stack and lamp. If the lamp remains lodged in the sensor body, carefully remove it with tweezers.
- 11 . If the spring in the lamp cavity comes out, place it back into the lamp cavity.
- 12 . Discard the old electrode stack.
- 13 . Hold the new electrode stack between the thumb and forefinger of one hand and place the window end of the lamp inside the O-ring seal in the new electrode stack with the other hand as shown below. Take care not to touch the lamp window.

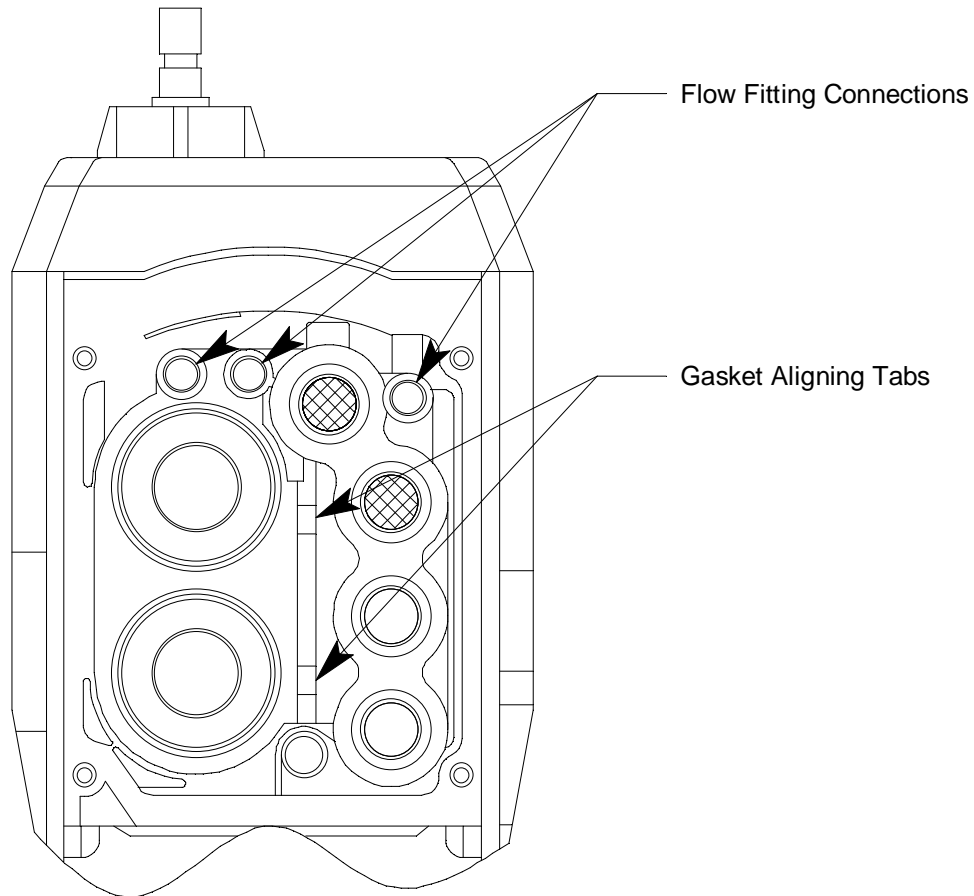


**Figure 37: Reinstalling Electrode Lamp**

- 14 . Twisting the lamp slightly during insertion will help to ensure the lamp window is snug against the stack's front electrode. The lamp should be supported by the O-ring.
- 15 . Continuing to hold the electrode stack between your forefinger and thumb, carefully insert the lamp into the lamp cavity in the sensor ensuring that the lamp remains in position.
- 16 . Press in the electrode stack firmly to ensure that the stack wing clips are engaged and the faces of the stack and sensor body are flush.
- 17 . Carefully line up the PID sensor's connections with the connections on the bottom of the socket and slowly insert the sensor in the socket.
- 18 . Do not attempt to push the sensor in farther once it makes contact with the bottom of the socket until you are sure that the sensor's connections are engaged with the socket's connections. If you feel that the connections did not engage, slightly rotate the sensor back and forth without putting pressure on it until you feel the connections engage.
- 19 . Push the sensor into the socket until it bottoms out.

- 20 . Place the sensor gasket and filters back over the sensors ensuring that it seals with the sensors and the flow fittings. The flow fitting connections need to be facing up and cannot be skewed sideways. The gasket must be pushed down in the center and secured under the gasket aligning tabs.

**Failure to install the sensor gasket appropriately may result in inaccurate gas readings.**



**Figure 38: Sensor Gasket Seating**

- 21 . Insert the flow chamber back into the instrument.
- 22 . Tighten the flow chamber's four screws that were loosened in Step 2.
- 23 . Start up the GX-6000 by pressing and briefly holding the POWER/ENTER button.
- 24 . To verify that the sensor gasket was inserted properly:
  - a. Plug the inlet with your finger.
  - b. Verify that the GX-6000 goes into low flow alarm. If the GX-6000 does not go into low flow alarm, turn the instrument off and attempt to seat the sensor gasket again.
- 25 . Calibrate the PID sensor as described in "Chapter 4: Calibration Mode" on page 70.

## General Parts List

Table 16 lists part numbers for the GX-6000's replacement parts and accessories.

**Table 16: General Parts List**

Part Number	Description
06-1248RK-03	Calibration kit tubing, 3 foot length
10-1093RK	Screw, for flow chamber
13-0112RK	Wrist strap
13-6022	DIN rail, 4" long
13-6022-01	DIN rail mounting kit for 1 charger, includes 4" DIN rail and 2 end clamps
13-6025	DIN rail, 14" long
13-6025-01	DIN rail mounting kit for 4 chargers, includes 14" DIN rail and 2 end clamps
13-6100	End clamp for DIN rail mounting of charger
17-1031RK	Tapered rubber nozzle, red
20-0326	Rubber boot, black
21-1833RK	Filter holder, clear plastic
33-0159RK	Hydrophobic filter, for instrument inlet and for probe
33-0560RK	PID sensor electrode stack, 0 - 50,000 ppb, 2 stacks
33-0560-01	PID sensor electrode stack, 0 - 50,000 ppb, 1 stack
33-0562	PID sensor electrode stack, 0 - 6,000 ppm, HPPM type
33-1112RK	Wire mesh disk filter, for instrument inlet
33-3013	Particle filter for probe
33-6092	VOC zero filter, charcoal, with tubing stubs and plugs (Included for low-range PID units, 10.0 eV/benzene units, 11.7 eV PID units, and PID/CO <sub>2</sub> combo units. Optional for high-range PID units.)
33-7102RK	Charcoal filter disk, 5 pack, for CO sensor
33-7114RK	Filter disk, H <sub>2</sub> S scrubber, 5 pack, for LEL sensor
47-5084RK	USB/IrDA adapter module, Legasic, for use with all premier portables (without USB cable)
47-5084RK-01	USB/IrDA adapter assembly, Legasic, for use with all premier portables (with module and USB cable)
47-5085RK	Cable, USB A to USB mini, 6 feet, for 47-5084RK USB/IrDA adapter module
47-5093	USB/IrDA adapter with cable and CD (not for use with Eagle 2)

**Table 16: General Parts List (cont.)**

<b>Part Number</b>	<b>Description</b>
49-0115RK	AC adapter
49-1120RK	AA size alkaline battery
49-1619	Li-ion battery pack
49-1620	Alkaline battery pack
49-2182-01	Battery charger, BC-6000, with 100 - 240 VAC adapter
49-2183	Battery charger, BC-6000, with 12 VDC adapter
51-1500RK	PID sensor replacement lamp, 0 - 50,000 ppb, for PID-001 sensor
51-1502	PID sensor replacement lamp, 0 - 6,000 ppm, HPPM type, for PID-002 sensor
51-1502-01	PID sensor replacement lamp/electrode stack set, 0 - 6,000 ppm, HPPM type, for PID-002 sensor
51-1503	PID sensor replacement lamp, for PID-001L and PID-002L sensor
65-7001RK	Dummy sensor, LEL, O <sub>2</sub> , CO, or H <sub>2</sub> S sensor position
65-7003	Dummy sensor, smart sensor position
71-0362	Operator's Manual, GX-6000 Standard 4 Gas + PID Configuration (this document)
71-0363	Operator's Manual, GX-6000 PID Only Configuration
71-0383	Operator's Manual, GX-6000 Data Logger Management Program
71-8010	GX-6000 Product CD, includes Data Logger Management Program, User Setup Program, and all operator's manuals
80-0006-XXP	Sample hose with integral probe, with hydrophobic filter and particle filter, no scrubber section. Replace "XX" with length in feet. 3 foot hose is standard. Available lengths for the GX-6000 are 3, 5, 10, 15, 20, 25, 30, 35, 40, 45, and 50 feet.
80-0172	Probe, with hydrophobic filter and particle filter, no scrubber section
80-0404RK	Dilution fitting, 1:1
81-0090RK-01	Calibration cylinder, steel, 34 liter, three-gas (CH <sub>4</sub> /O <sub>2</sub> /CO)
81-0090RK-03	Calibration cylinder, steel, 103 liter, three-gas (CH <sub>4</sub> /O <sub>2</sub> /CO)
81-0103RK-04	Calibration cylinder, isobutylene, 100 ppm in air, 34 liter aluminum
81-0104RK-04	Calibration cylinder, isobutylene, 10 ppm in air, 34 liter aluminum
81-0143RK-02	Calibration cylinder, 5-gas (Proprietary blend of IBL, CH <sub>4</sub> , O <sub>2</sub> , H <sub>2</sub> S, CO), 58-liter aluminum

**Table 16: General Parts List (cont.)**

<b>Part Number</b>	<b>Description</b>
81-0143RK-04	Calibration cylinder, 5-gas (Proprietary blend of IBL, CH <sub>4</sub> , O <sub>2</sub> , H <sub>2</sub> S, CO), 34-liter aluminum
81-0154RK-02	Calibration cylinder, aluminum, 58 liter; four-gas (CH <sub>4</sub> /O <sub>2</sub> / H <sub>2</sub> S/CO)
81-0154RK-04	Calibration cylinder, aluminum, 34 liter; four-gas (CH <sub>4</sub> /O <sub>2</sub> / H <sub>2</sub> S/CO)
81-1054RK	Regulator, demand-flow type (for 58- and 103-liter aluminum or steel, and 34-liter aluminum calibration cylinders)
81-1055RK	Regulator, demand-flow type (for 17- and 34-liter steel cylinder)
81-6AAX-DLV	Calibration kit: 34 liter four-gas (CH <sub>4</sub> /O <sub>2</sub> /H <sub>2</sub> S/CO) cylinder, 34 liter 10 ppm IBL in air cylinder, demand flow regulator, calibration tubing
81-6ABI-DLV	Calibration kit: 34 liter five-gas (IBL/CH <sub>4</sub> /O <sub>2</sub> /H <sub>2</sub> S/CO) cylinder, 34 liter 5 ppm SO <sub>2</sub> in N <sub>2</sub> cylinder, demand flow regulator, calibration tubing
81-6ABK-DLV	Calibration kit: 34 liter five-gas (IBL/CH <sub>4</sub> /O <sub>2</sub> /H <sub>2</sub> S/CO) cylinder, 34 liter 10 ppm NO <sub>2</sub> in N <sub>2</sub> cylinder, demand flow regulator, calibration tubing
81-6ABL-DLV	Calibration kit: 34 liter five-gas (IBL/CH <sub>4</sub> /O <sub>2</sub> /H <sub>2</sub> S/CO) cylinder, 34 liter 10 ppm HCN in N <sub>2</sub> cylinder, demand flow regulator, calibration tubing
81-6ABX-DLV	Calibration kit: 34 liter five-gas (IBL/CH <sub>4</sub> /O <sub>2</sub> /H <sub>2</sub> S/CO) cylinder, demand flow regulator, calibration tubing
81-6AXX	Calibration kit: 58 liter four-gas (CH <sub>4</sub> /O <sub>2</sub> /H <sub>2</sub> S/CO) cylinder, demand flow regulator, calibration tubing
81-6AXX-DLV	Calibration kit: 34 liter four-gas (CH <sub>4</sub> /O <sub>2</sub> /H <sub>2</sub> S/CO) cylinder, demand flow regulator, calibration tubing
81-6XAX-DLV	Calibration kit: 34 liter 10 ppm IBL in air cylinder, demand flow regulator, calibration tubing
81-6XBX-DLV	Calibration kit: 34 liter 100 ppm IBL in air cylinder, demand flow regulator, calibration tubing
82-0003RK	Electrode stack removal tool
82-0300RK	Lamp cleaning kit with electrode stack removal tool
ES-1821	Carbon monoxide (CO) sensor
ES-1827i	Hydrogen sulfide (H <sub>2</sub> S) sensor
NC-6264A	LEL combustible sensor, catalytic
OS-BM2	Oxygen sensor
PID-001L	PID sensor, 0 - 50,000 ppb VOC, improved type
PID-002L	PID sensor, 0 - 6,000 ppm VOC, improved type

# Appendix A: Maintenance Mode

## Overview

This appendix describes the GX-6000 in Maintenance Mode. The GX-6000 is factory-set to suit most applications. Update settings in Maintenance Mode only if required for your specific application. Maintenance Mode items and their factory settings are listed in Table 17 below.

**Table 17: Maintenance Mode Menu Items**

Menu Item (Page # of Description)	Choices or Action	Factory Setting
DATE (pg.141)	user-entered date/time	current date/ time
DATE FORMAT (pg.141)	<ul style="list-style-type: none"> <li>• DD/MM/YYYY</li> <li>• MM/DD/YYYY</li> <li>• YYYY/MM/DD</li> </ul>	MM/DD/YYYY
GAS CALIBRATION (pg.141)	perform a calibration	N/A
BUMP TEST (pg.142)	perform a bump test	N/A
CAL SETTING (pg.142)		
<ul style="list-style-type: none"> <li>• CAL REMINDER (pg.142)</li> </ul>	<ul style="list-style-type: none"> <li>• ON</li> <li>• OFF</li> </ul>	ON
<ul style="list-style-type: none"> <li>• CAL INTERVAL (pg.143)</li> </ul>	1-365 DAYS	90 DAYS
<ul style="list-style-type: none"> <li>• CAL EXPRD (pg.143)</li> </ul>	<ul style="list-style-type: none"> <li>• CONFIRM TO USE</li> <li>• CANNOT USE</li> <li>• NO EFFECT</li> </ul>	CONFIRM TO USE
<ul style="list-style-type: none"> <li>• CAL CHECK GAS (pg.144)</li> </ul>	<ul style="list-style-type: none"> <li>• 4 GAS</li> <li>• ALL GAS</li> </ul>	4 GAS
<ul style="list-style-type: none"> <li>• ESCAPE</li> </ul>	return to main menu	N/A
BUMP SETTING (pg.144)		
<ul style="list-style-type: none"> <li>• BUMP DISP (pg.144)</li> </ul>	<ul style="list-style-type: none"> <li>• ON</li> <li>• OFF</li> </ul>	OFF
<ul style="list-style-type: none"> <li>• BUMP PARAMETERS (pg.145)</li> </ul>		
<ul style="list-style-type: none"> <li>• GAS TIME (pg.145)</li> </ul>	<ul style="list-style-type: none"> <li>• 30 SEC</li> <li>• 45 SEC</li> <li>• 60 SEC</li> <li>• 90 SEC</li> </ul>	30 SEC

**Table 17: Maintenance Mode Menu Items**

<b>Menu Item (Page # of Description)</b>	<b>Choices or Action</b>	<b>Factory Setting</b>
• CHECK (pg.145)	<ul style="list-style-type: none"> <li>• 10%</li> <li>• 20%</li> <li>• 30%</li> <li>• 40%</li> <li>• 50%</li> </ul>	30%
• CAL TIME (pg.146)	<ul style="list-style-type: none"> <li>• 90 SEC</li> <li>• 120 SEC</li> </ul>	90 SEC
• AUTO CAL (pg.146)	<ul style="list-style-type: none"> <li>• ON</li> <li>• OFF</li> </ul>	ON
• ESCAPE	return to BUMP PARAMETERS menu	N/A
• BUMP REMINDER (pg.146)	<ul style="list-style-type: none"> <li>• ON</li> <li>• OFF</li> </ul>	OFF
• BUMP INTERVAL (pg.147)	0-30 DAYS	30 DAYS
• BUMP EXPRD (pg.147)	<ul style="list-style-type: none"> <li>• CONFIRM TO USE</li> <li>• CANNOT USE</li> <li>• NO EFFECT</li> </ul>	CONFIRM TO USE
• BUMP CHECK GAS (pg.148)	<ul style="list-style-type: none"> <li>• 4 GAS</li> <li>• ALL GAS</li> </ul>	4 GAS
• ESCAPE	return to main menu	N/A
ALARM SETTING (pg.148)		
• ALARM POINTS (pg.149)	set alarm points for any channel	see Table 1 on page 11
• ALARM LATCHING (pg.150)	<ul style="list-style-type: none"> <li>• LATCHING</li> <li>• SELF RESET</li> </ul>	LATCHING
• ALARM SILENCE (pg.150)	<ul style="list-style-type: none"> <li>• ON</li> <li>• OFF</li> </ul>	ON
• ESCAPE	return to main menu	N/A
PUMP OFF DISP (pg.151)	<ul style="list-style-type: none"> <li>• ON</li> <li>• OFF</li> </ul>	OFF
ID DISPLAY (pg.151)	<ul style="list-style-type: none"> <li>• ON</li> <li>• OFF</li> </ul>	OFF
BACK LIGHT TIME (pg.151)	OFF - 255 SEC	30 SEC

**Table 17: Maintenance Mode Menu Items**

Menu Item (Page # of Description)	Choices or Action	Factory Setting
LANGUAGE (pg.152)	<ul style="list-style-type: none"> <li>• ENGLISH</li> <li>• JAPANESE</li> <li>• ITALIAN</li> <li>• SPANISH</li> <li>• GERMAN</li> <li>• FRENCH</li> <li>• PORTUGUESE</li> <li>• RUSSIAN</li> <li>• KOREAN</li> </ul>	ENGLISH
LUNCH BREAK (pg.152)	<ul style="list-style-type: none"> <li>• ON</li> <li>• OFF</li> </ul>	OFF
AUTO ZERO (pg.152)	<ul style="list-style-type: none"> <li>• ON</li> <li>• OFF</li> </ul>	OFF
DEMAND ZERO (pg.153)	<ul style="list-style-type: none"> <li>• ON</li> <li>• OFF</li> </ul>	ON
ZERO FOLLOWER (pg.153)	For each channel: <ul style="list-style-type: none"> <li>• ON</li> <li>• OFF</li> </ul>	ON
ZERO SUPPRESS (pg.153)	0 - 3% of full scale	2% of full scale*
IR AUTO RANGE (pg.153)	<ul style="list-style-type: none"> <li>• AUTO RANGE</li> <li>• LOW ONLY</li> </ul>	AUTO RANGE
CONFIRMATION (pg.153)	<ul style="list-style-type: none"> <li>• ON</li> <li>• OFF</li> </ul>	OFF
<ul style="list-style-type: none"> <li>• CONFIRMATION INTERVAL (if CONFIRMATION set to ON)</li> </ul>	1 - 60 MIN	5 MIN
KEY TONE (pg.154)	<ul style="list-style-type: none"> <li>• ON</li> <li>• OFF</li> </ul>	ON
INERT MODE (pg.154)	<ul style="list-style-type: none"> <li>• ON</li> <li>• OFF</li> </ul>	OFF
L. /B. MODE (pg.154)	<ul style="list-style-type: none"> <li>• OFF</li> <li>• LEAK CHECK MODE</li> <li>• BAR HOLE MODE</li> <li>• BAR HOLE MODE</li> <li>• LEAK CHECK MODE</li> </ul>	OFF



**Table 17: Maintenance Mode Menu Items**

<b>Menu Item (Page # of Description)</b>	<b>Choices or Action</b>	<b>Factory Setting</b>
BAR HOLE TIME (pg.155)	<ul style="list-style-type: none"> <li>• 30 SEC</li> <li>• 45 SEC</li> <li>• 60 SEC</li> </ul>	30 SEC
CO DISPLAY (pg.155)	<ul style="list-style-type: none"> <li>• ON</li> <li>• OFF</li> </ul>	OFF
MAN DOWN (pg.156)		
<ul style="list-style-type: none"> <li>• MAN DOWN (pg.156)</li> </ul>	<ul style="list-style-type: none"> <li>• ON</li> <li>• OFF</li> </ul>	OFF
<ul style="list-style-type: none"> <li>• PANIC (pg.156)</li> </ul>	<ul style="list-style-type: none"> <li>• ON</li> <li>• OFF</li> </ul>	ON
<ul style="list-style-type: none"> <li>• WARNING 1 TIME (pg.157)</li> </ul>	10 - 75 SEC	60 SEC
<ul style="list-style-type: none"> <li>• WARNING 2 TIME (pg.157)</li> </ul>	60 - 90 SEC	75 SEC
<ul style="list-style-type: none"> <li>• ALARM TIME (pg.157)</li> </ul>	75 - 120 SEC	90 SEC
<ul style="list-style-type: none"> <li>• ESCAPE</li> </ul>	return to main menu	N/A
LOG SETTING (pg.158)		
<ul style="list-style-type: none"> <li>• LOG INTERVAL (pg.158)</li> </ul>	<ul style="list-style-type: none"> <li>• 10 SEC</li> <li>• 20 SEC</li> <li>• 30 SEC</li> <li>• 60 SEC</li> <li>• 120 SEC</li> <li>• 180 SEC</li> <li>• 300 SEC</li> <li>• 600 SEC</li> </ul>	300 SEC
<ul style="list-style-type: none"> <li>• LOG CLEAR DISP (pg.158)</li> </ul>	<ul style="list-style-type: none"> <li>• ON</li> <li>• OFF</li> </ul>	ON
<ul style="list-style-type: none"> <li>• LOG OVER WRITE (pg.158)</li> </ul>	<ul style="list-style-type: none"> <li>• ON</li> <li>• OFF</li> </ul>	ON
<ul style="list-style-type: none"> <li>• ESCAPE</li> </ul>	return to main menu	N/A
FLOW ADJUST (pg.159)	set the low flow alarm	N/A
ROM/SUM (pg.160)	view the ROM number and checksum	N/A
PASSWORD (pg.160)	<ul style="list-style-type: none"> <li>• ON</li> <li>• OFF</li> </ul>	ON (0006)
RESTORE DEFAULT (pg.161)	restore default settings	N/A

**Table 17: Maintenance Mode Menu Items**

<b>Menu Item (Page # of Description)</b>	<b>Choices or Action</b>	<b>Factory Setting</b>
START MEASURE (pg.162)	enter Measuring Mode	N/A
* PID channel's zero suppression is always 0% regardless of what value is shown.		

---

## Tips for Using Maintenance Mode

- When in the main menu, the cursor (>) indicates which menu item will be selected if the POWER/ENTER button is pressed and released.
- Use the SHIFT ▼ (PANIC) button to move the cursor down through the main menu and submenu items, and to lower values or change the setting in a specific option.
- Use the ▲AIR button to move the cursor up through the main menu and submenu items, and to raise values or change the setting in a specific option.
- Use the POWER/ENTER button to enter a menu item with the cursor next to it and to enter and save settings during programming.
- An adjustable parameter that is flashing can be adjusted with the ▲AIR and SHIFT ▼ (PANIC) buttons.
- Press the DISP/LOCK button while in a screen where you are entering or updating parameters to exit the screen without saving any changes. You can also use the DISP/LOCK button to back out of submenus and return to the main menu.

---

## Using Maintenance Mode

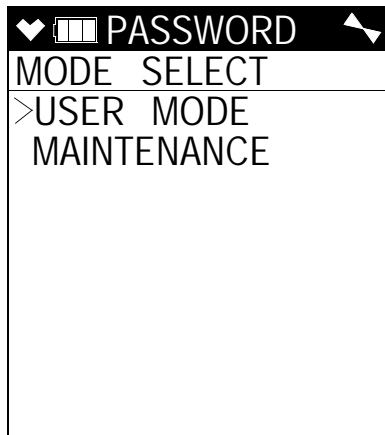
**WARNING:** *The GX-6000 is not in operation as a gas detector while in Maintenance Mode.*

1. Take the GX-6000 to a non-hazardous location and turn it off if it is on.
2. Press and hold the ▲AIR and SHIFT ▼ (PANIC) buttons, then press and hold the POWER/ENTER button. When you hear a beep, release the buttons.

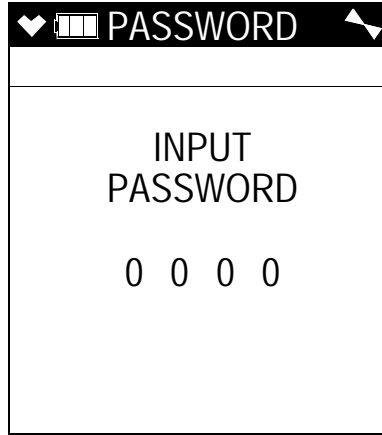
- The screen that appears will depend on the setting of User Mode's **PASSWORD** item.

If User Mode's **PASSWORD** is set to **OFF** (factory setting), continue with Step 4.

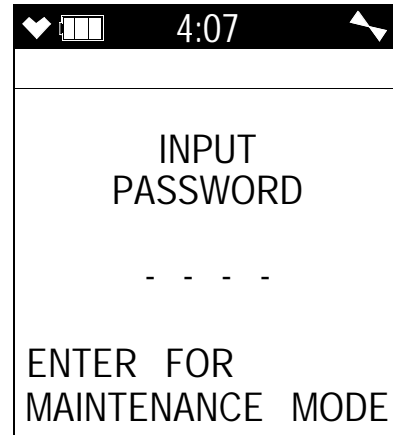
If User Mode's **PASSWORD** is set to **ON**, continue with Step 6.



User **PASSWORD OFF**  
Maint. **PASSWORD ON**  
or **OFF**

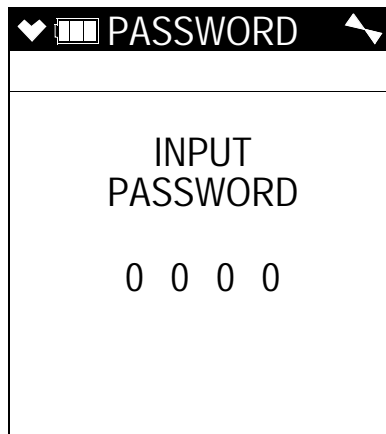


User **PASSWORD ON**  
Maint. **PASSWORD ON**

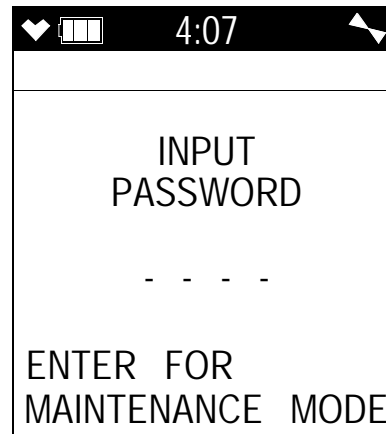


User **PASSWORD ON**  
Maint. **PASSWORD OFF**

- If User Mode's **PASSWORD** has been set to **OFF**, the Mode Select screen will appear, prompting you to choose the mode you'd like to enter.
- Use the **▲AIR** and **SHIFT ▼(PANIC)** buttons to put the cursor in front of **MAINTENANCE** and press and release the **POWER/ENTER** button. A password screen will appear. Continue to Step 7.
- If User Mode's **PASSWORD** has been set to **ON**, a password screen will appear.
- The appearance of the password screen will be affected by Maintenance Mode's **PASSWORD** setting.



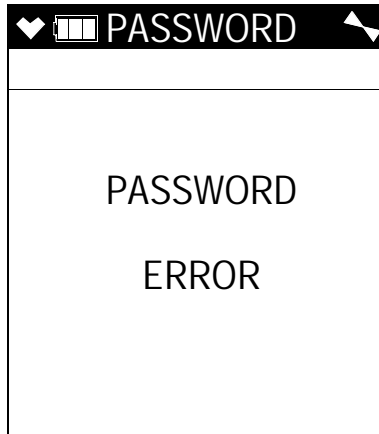
Maint. **PASSWORD set to ON**



Maint. **PASSWORD set to OFF**

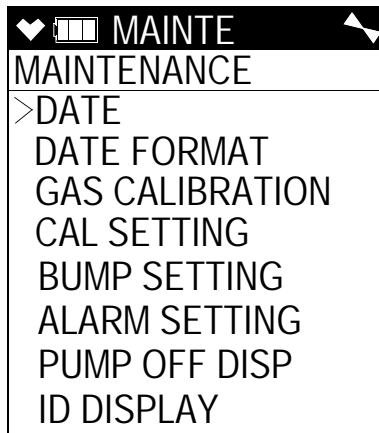
- If Maintenance Mode's **PASSWORD** is set to **OFF**, continue to Step 11.

- 9 . If Maintenance Mode's **PASSWORD** is set to **ON** (factory setting), enter the password by using the ▲AIR and SHIFT ▼(PANIC) buttons to select each password number and then pressing and releasing the POWER/ENTER button to enter it and move on to the next number until all of the numbers are entered. The password is 0006.
- 10 . If you enter an incorrect password, an error screen will appear.



You must turn the unit off and reenter Maintenance Mode using the correct password. Continue to Step 12.

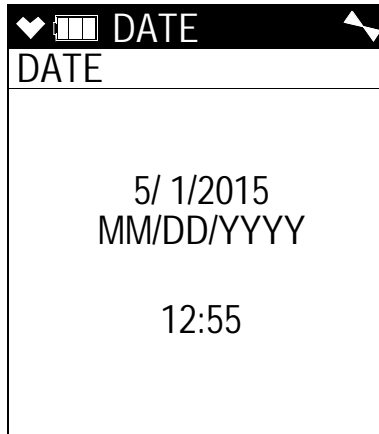
- 11 . If Maintenance Mode's **PASSWORD** is set to **OFF**, press and release the POWER/ENTER button to enter Maintenance Mode. There is no need to enter a password. The password screen appears even if **PASSWORD** is set to **OFF** so that a special factory mode can be accessed, if necessary.
- 12 . The main menu displays. It displays eight menu items at a time.



- 13 . Use the ▲AIR or SHIFT ▼(PANIC) button to move the cursor up and down through the menu items. Additional items are available above and below the items currently displayed on the screen. They will appear as you scroll farther up or down the current list using the ▲AIR or SHIFT ▼(PANIC) buttons.

## Setting the Date and Time

1. From the main menu, place the cursor next to **DATE**.
2. Press and release POWER/ENTER. The date and time will be displayed with the year flashing.



3. Use ▲AIR or SHIFT ▼ (PANIC) to display the desired year.
4. Press and release POWER/ENTER to save the setting. The month setting flashes.
5. Repeat Step 3 and Step 4 to enter the month, day, hours, and minutes settings. The main menu displays after you enter the seconds setting.

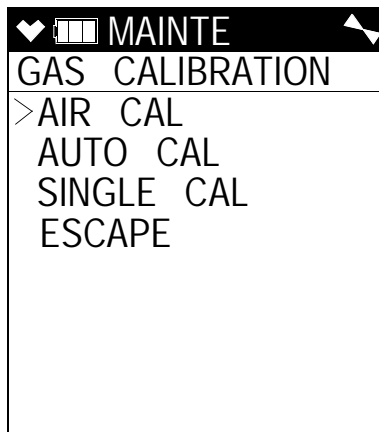
## Setting the Date Format

The date can be displayed in three ways, **MM/DD/YYYY** (factory setting), **DD/MM/YYYY**, or **YYYY/MM/DD**.

1. From the main menu, place the cursor next to **DATE FORMAT**.
2. Press and release POWER/ENTER. The Date Format screen appears with the current setting displayed.
3. Use ▲AIR or SHIFT ▼ (PANIC) to display the desired setting.
4. Press and release POWER/ENTER to save the setting and return to the main menu.

## Performing a Calibration

1. From the main menu, place the cursor next to **GAS CALIBRATION**.
2. Press and release POWER/ENTER. The Gas Calibration Screen appears.



3. Use the ▲AIR or SHIFT ▼ (PANIC) buttons to move the cursor to the operation you wish to perform.

See “Calibrating Using the Auto Calibration Method” on page 72 for instructions to perform an automatic calibration.

See “Calibrating Using the Single Calibration Method” on page 83 for instructions to perform a single calibration.

## Performing a Bump Test

---

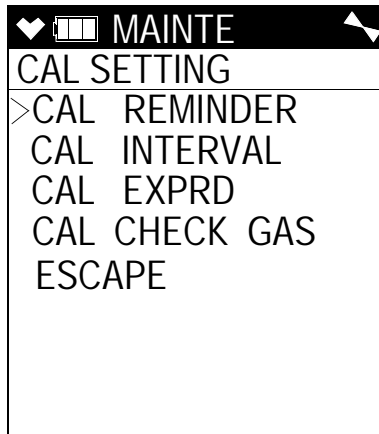
**NOTE:** The **BUMP DISP** menu item in Maintenance Mode is factory set to **OFF**. The **BUMP TEST** menu item will not appear unless **BUMP DISP** is set to **ON**. See “Updating the Bump Display Setting” on page 144 for instructions.

---

Entering the **BUMP TEST** menu item brings you to the first of the Gas Select Screens. See “Performing a Bump Test” on page 88 for instructions, starting at Step 8.

## Updating Calibration Settings

The **CAL SETTING** menu item in Maintenance Mode has a sub menu with 5 menu items: **CAL REMINDER**, **CAL INTERVAL**, **CAL EXPRD**, **CAL CHECK GAS**, and **ESCAPE**.



1. From the main menu, place the cursor next to **CAL SETTING**.
2. Press and release POWER/ENTER. The **CAL SETTING** menu appears.

### **Updating the Calibration Reminder Setting**

With **CAL REMINDER** set to **ON** (factory setting), the GX-6000 will give an indication at start up if it is due for calibration. The type of indication will depend on the **CAL EXPRD** setting (see “Updating the Calibration Expired Setting” on page 143).

With **CAL REMINDER** set to **OFF**, the GX-6000 will not give an indication at start up if it is due for calibration.

1. From the **CAL SETTING** screen, place the cursor next to **CAL REMINDER**.
2. Press and release POWER/ENTER. The Calibration Reminder Screen appears.
3. Use ▲AIR or SHIFT ▼ (PANIC) to display the desired setting.
4. Press and release POWER/ENTER to save the setting and return to the **CAL SETTING** menu.

### ***Updating the Calibration Interval***

This setting defines the amount of time between calibrations. The time can be set in 1 day increments. The minimum setting is 1 day and the maximum setting is 365 days. The factory setting is 90 days.

1. From the **CAL SETTING** screen, place the cursor next to **CAL INTERVAL**.
2. Press and release **POWER/ENTER**. The Set Calibration Interval Screen appears.
3. Use **▲AIR** or **SHIFT ▼ (PANIC)** to display the desired setting.

**Tip:** Press and hold **▲AIR** or **SHIFT ▼ (PANIC)** to rapidly scroll through the settings.

4. Press and release **POWER/ENTER** to save the setting and return to the **CAL SETTING** menu.

### ***Updating the Calibration Expired Setting***

This item defines what indication is given during start up when calibration is due and **CAL REMINDER** is set to **ON**.

With **CAL EXPRD** set to **CONFIRM TO USE** (factory setting), the GX-6000 will give an indication at start up if calibration is past due and will require the user to decide whether to perform a calibration or continue and use the GX-6000 without calibrating. Press and release **DISP/LOCK** to continue without calibrating or **POWER/ENTER** to perform a calibration.

With **CAL EXPRD** set to **CANNOT USE**, if the unit is due for calibration, the GX-6000 will give an indication at start up that calibration is past due and will prompt you to press and release **POWER/ENTER** to enter Calibration Mode and perform a calibration. Using any other button will have no effect. A successful calibration must be performed in order to use the instrument.

---

**NOTE:** Even if the password function is turned on in **PASSWORD**, no password will be required to perform a calibration during startup.

---

With **CAL EXPRD** set to **NO EFFECT**, the GX-6000 will give an indication at startup that calibration is past due. If desired, the **POWER/ENTER** button can be pressed to enter Calibration Mode and perform a calibration but it is not necessary to acknowledge the calibration due indication. The warm-up sequence will continue on its own.

1. From the **CAL SETTING** screen, place the cursor next to **CAL EXPRD**.
2. Press and release **POWER/ENTER**. The Calibration Expired Screen appears.
3. Use **▲AIR** or **SHIFT ▼ (PANIC)** to display the desired setting.
4. Press and release **POWER/ENTER** to save the setting and return to the **CAL SETTING** menu.

### **Updating the Calibration Check Gas Setting**

This item defines which sensors are used to update the calibration reminder screen. With **CAL CHECK GAS** set to **4 GAS** (factory setting), the calibration dates for only the standard 4 sensors (LEL, O<sub>2</sub>, H<sub>2</sub>S, and CO) are used to determine if a calibration is due.

With **CAL CHECK GAS** set to **ALL GAS**, the calibration dates for the standard 4 sensors along with the PID sensor and any other installed smart sensors are used to determine if a calibration is due.

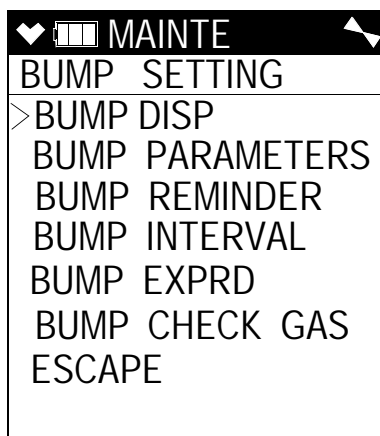
1. From the **CAL SETTING** screen, place the cursor next to **CAL CHECK GAS**.
2. Press and release **POWER/ENTER**. The Calibration Reminder Screen appears.
3. Use **▲AIR** or **SHIFT ▼(PANIC)** to display the desired setting.
4. Press and release **POWER/ENTER** to save the setting and return to the **CAL SETTING** menu.

### **Returning to the Maintenance Mode Menu**

1. From the **CAL SETTING** screen, place the cursor next to **ESCAPE**.
2. Press and release **POWER/ENTER**. The instrument will return to the main menu.

### **Updating Bump Test Settings**

The **CAL SETTING** menu item in Maintenance Mode has a sub menu with 7 menu items: **BUMP DISP**, **BUMP PARAMETERS**, **BUMP REMINDER**, **BUMP INTERVAL**, **BUMP EXPRD**, **BUMP CHECK GAS**, and **ESCAPE**.



1. From the main menu, place the cursor next to **BUMP SETTING**.
2. Press and release **POWER/ENTER**. The **BUMP SETTING** menu appears.

### **Updating the Bump Display Setting**

With **BUMP DISP** set to **ON**, the **BUMP TEST** menu item will appear in Calibration Mode.

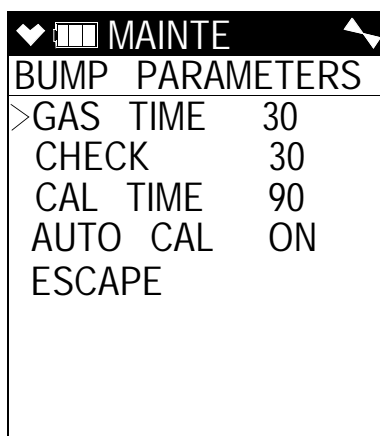
With **BUMP DISP** set to **OFF** (factory setting), the **BUMP TEST** menu item will not appear in Calibration Mode.

1. From the **BUMP SETTING** screen, place the cursor next to **BUMP DISP**.
2. Press and release **POWER/ENTER**. The Bump Display Screen appears.
3. Use **▲AIR** or **SHIFT ▼(PANIC)** to display the desired setting.
4. Press and release **POWER/ENTER** to save the setting and return to the **BUMP SETTING** menu.



### **Updating the Bump Parameters**

The **BUMP PARAMETERS** menu item in the Bump Test Settings sub-menu has its own sub-menu with 5 menu items: **GAS TIME**, **CHECK**, **CAL TIME**, **AUTO CAL**, and **ESCAPE**.



The screenshot shows a menu structure. At the top is a header bar with a downward arrow, a battery icon, and the text 'MAINTENANCE'. Below this is a sub-menu titled 'BUMP PARAMETERS'. The sub-menu contains five items: 'GAS TIME 30', 'CHECK 30', 'CAL TIME 90', 'AUTO CAL ON', and 'ESCAPE'. A cursor is positioned to the left of 'GAS TIME'.

MAINTENANCE	
BUMP PARAMETERS	
>	GAS TIME 30
	CHECK 30
	CAL TIME 90
	AUTO CAL ON
	ESCAPE

1. From the **BUMP SETTING** screen, place the cursor next to **BUMP PARAMETERS**.
2. Press and release POWER/ENTER. The Bump Parameters Menu Screen appears.

#### **Updating the GAS TIME Setting**

The **GAS TIME** is the amount of time that the instrument is exposed to gas during a bump test. The available choices are 30 seconds (factory setting), 45 seconds, 60 seconds, and 90 seconds.

1. From the **BUMP PARAMETERS** screen, place the cursor next to **GAS TIME**.
2. Press and release POWER/ENTER. The current Gas Time value will begin to flash.
3. Use ▲AIR or SHIFT ▼ (PANIC) to display the desired setting.
4. Press and release POWER/ENTER to save the setting. The value will stop flashing.

#### **Updating the CHECK Setting**

The **CHECK** is the bump test tolerance value and is represented as a percentage. It is the percentage that the bump test reading can differ from the actual gas concentration. If the bump test reading differs more, the bump test will fail. The available values are 10%, 20% 30% (factory setting), 40%, and 50%.

1. From the **BUMP PARAMETERS** screen, place the cursor next to **CHECK**.
2. Press and release POWER/ENTER. The current Check value will begin to flash.
3. Use ▲AIR or SHIFT ▼ (PANIC) to display the desired setting.
4. Press and release POWER/ENTER to save the setting. The value will stop flashing.

### *Updating the CAL TIME Setting*

The **CAL TIME** is the total time the instrument is exposed to calibration gas when a bump test fails if **AUTO CAL** is set to **ON**. The bump test time is deducted from the calibration time. For example, if the **CAL TIME** is set to 90 seconds and the **GAS TIME** is set to 30 seconds, if the bump test fails, the GX-6000 will only be exposed to gas for an additional 60 seconds. The available values are 90 seconds (factory setting), and 120 seconds.

1. From the **BUMP PARAMETERS** screen, place the cursor next to **CAL TIME**.
2. Press and release **POWER/ENTER**. The current Cal Time value will begin to flash.
3. Use **▲AIR** or **SHIFT ▼(PANIC)** to display the desired setting.
4. Press and release **POWER/ENTER** to save the setting. The value will stop flashing.

### *Updating the AUTO CAL Setting*

With **AUTO CAL** set to **ON** (factory setting), if a bump test fails, the unit will automatically begin a calibration. If **AUTO CAL** is set to **OFF** and a bump test fails, nothing will happen.

1. From the **BUMP PARAMETERS** screen, place the cursor next to **AUTO CAL**.
2. Press and release **POWER/ENTER**. The current Auto Cal setting will begin to flash.
3. Use **▲AIR** or **SHIFT ▼(PANIC)** to display the desired setting.
4. Press and release **POWER/ENTER** to save the setting. The setting will stop flashing.

### *Returning to the BUMP SETTINGS Menu*

1. From the **BUMP PARAMETERS** screen, place the cursor next to **ESCAPE**.
2. Press and release **POWER/ENTER**. The instrument will return to the **BUMP SETTING** screen.

### *Updating the Bump Reminder Setting*

With **BUMP REMINDER** set to **ON**, the GX-6000 will give an indication at start up if it is due for bump testing. The type of indication will depend on the **BUMP EXPRD** setting (see “Updating the Bump Expired Setting” on page 147).

---

**NOTE:** If **BUMP REMINDER** is set to **ON** but **BUMP DISP** is set to **OFF**, the instrument will alert you if a bump test is due but the bump test item will not appear in Calibration Mode.

---

With **BUMP REMINDER** set to **OFF** (factory setting), the GX-6000 will not give an indication at start up if it is due for bump testing.

1. From the **BUMP SETTING** screen, place the cursor next to **BUMP REMINDER**.
2. Press and release **POWER/ENTER**. The current Bump Reminder setting will be displayed.
3. Use **▲AIR** or **SHIFT ▼(PANIC)** to display the desired setting.
4. Press and release **POWER/ENTER** to save the setting. The instrument will return to the **BUMP SETTING** screen.

### ***Updating the Bump Interval***

This setting defines the amount of time between bump tests. The time can be set in 1 day increments. The minimum setting is 0 days and the maximum setting is 30 days. The factory setting is 30 days.

1. From the **BUMP SETTING** screen, place the cursor next to **BUMP INTERVAL**.
2. Press and release POWER/ENTER. The current Bump Interval setting will be displayed.
3. Use **▲AIR** or **SHIFT ▼ (PANIC)** to display the desired setting.
4. Press and release POWER/ENTER to save the setting. The instrument will return to the **BUMP SETTING** screen.

### ***Updating the Bump Expired Setting***

This item defines what indication is given during start up when a bump test is due and **BUMP REMINDER** is set to **ON**.

With **BUMP EXPRD** set to **CONFIRM TO USE** (factory setting), the GX-6000 will give an indication at start up if a bump test is past due and will require the user to decide whether to perform a bump test or continue and use the GX-6000 without bump testing. Press and release **RESET** to continue without calibrating or **POWER/ENTER** to enter Calibration Mode.

With **BUMP EXPRD** set to **CANNOT USE**, if the unit is due for bump testing, the GX-6000 will give an indication at start up that a bump test is past due and will prompt you to press and release **POWER/ENTER** to enter Calibration Mode and perform a bump test. Using any other button will have no effect. A successful bump test must be performed in order to use the instrument.

---

**NOTE:** Even if the password function is turned on in **PASSWORD**, no password will be required to perform a bump test during startup.

---

---

**NOTE:** If **BUMP DISP** is set to **OFF**, the bump test menu item will not appear in Calibration Mode even though the instrument is prompting you to perform a bump test. A bump test can always be performed in Maintenance Mode, if necessary.

---

With **BUMP EXPRD** set to **NO EFFECT**, the GX-6000 will give an indication at startup that a bump test is past due. If desired, the **POWER/ENTER** button can be pressed to enter Calibration Mode and perform a bump test but it is not necessary to acknowledge the bump test due indication. The warm-up sequence will continue on its own.

1. From the **BUMP SETTING** screen, place the cursor next to **BUMP EXPRD**.
2. Press and release **POWER/ENTER**. The current Bump Expired setting will be displayed.
3. Use **▲AIR** or **SHIFT ▼ (PANIC)** to display the desired setting.
4. Press and release **POWER/ENTER** to save the setting. The instrument will return to the **BUMP SETTING** screen.

### **Updating the Bump Check Gas Setting**

This item defines which sensors are used to update the bump test reminder screen. With **BUMP CHECK GAS** set to **4 GAS** (factory setting), the bump test dates for only the standard 4 sensors (LEL, O2, H2S, and CO) are used to determine if a bump test is due.

With **BUMP CHECK GAS** set to **ALL GAS**, the bump test dates for the standard 4 sensors along with the PID sensor and any other installed smart sensors are used to determine if a bump test is due.

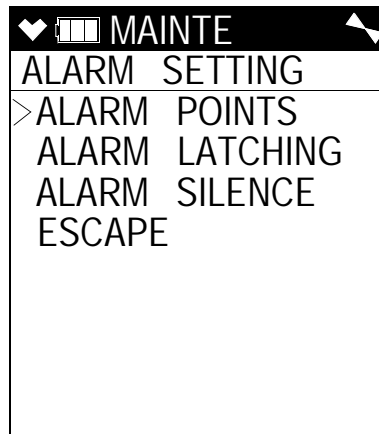
- 1 . From the **BUMP SETTING** screen, place the cursor next to **BUMP CHECK GAS**.
- 2 . Press and release **POWER/ENTER**. The current Bump Check Gas setting will be displayed.
- 3 . Use **▲AIR** or **SHIFT ▼(PANIC)** to display the desired setting.
- 4 . Press and release **POWER/ENTER** to save the setting. The instrument will return to the **BUMP SETTING** screen.

### **Returning to the Maintenance Mode Menu**

- 1 . From the **BUMP SETTING** screen, place the cursor next to **ESCAPE**.
- 2 . Press and release **POWER/ENTER**. The instrument will return to the main menu.

### **Updating Alarm Parameters**

The **ALARM SETTING** menu item in Maintenance Mode has a sub menu with 4 menu items: **ALARM POINTS**, **ALARM LATCHING**, **ALARM SILENCE**, and **ESCAPE**.

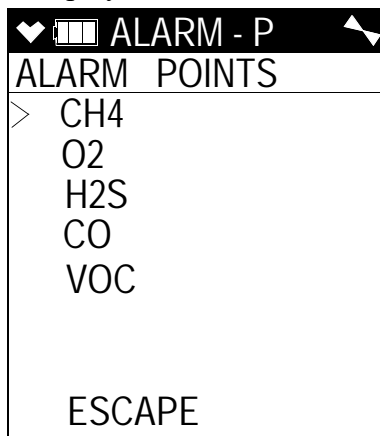


- 1 . From the main menu, place the cursor next to **ALARM SETTING**.
- 2 . Press and release **POWER/ENTER**. The **ALARM SETTING** menu appears.

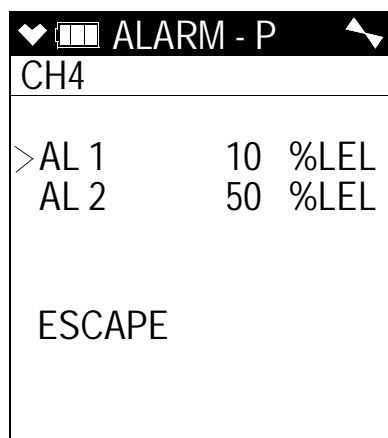
## Updating the Alarm Point Settings

This menu item allows you to update one or more alarm points (the reading at which the GX-6000 recognizes the alarm condition). See Table 1 on page 11 for alarm point factory settings.

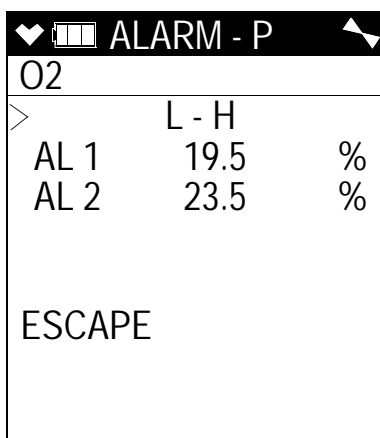
1. From the **ALARM SETTING** menu, place the cursor next to **ALARM POINTS**.
2. Press and release **POWER/ENTER**. The Alarm Points Screen appears and all detection channels are displayed.



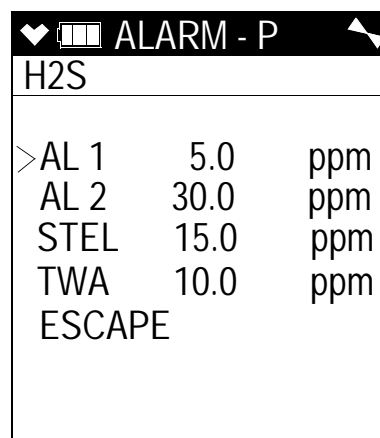
3. Move the cursor next to the channel of the alarm point you want to update. Press and release **POWER/ENTER**. The channel's alarm points and alarm operation (oxygen only) are displayed.



Catalytic LEL



Oxygen



H2S

4. Move the cursor next to the alarm point or alarm operation (oxygen only) that you want to update.

If you selected the oxygen channel, you can set the alarm rising/falling operation in addition to the alarm points.

5. Press and release **POWER/ENTER**. The alarm point or alarm operation (oxygen only) will begin to flash.

6. Use ▲AIR and SHIFT ▼ (PANIC) to adjust the alarm point or alarm operation (oxygen only) to the desired setting. Keep the following in mind:
  - Alarm 1 cannot be set higher than Alarm 2 and Alarm 2 cannot be set lower than Alarm 1.
  - In addition to setting the oxygen alarm points, you can also select one of the following operation modes: Alarm 1 decreasing and Alarm 2 increasing (**L-H**); Alarm 1 and Alarm 2 decreasing (**L-LL**); Alarm 1 and Alarm 2 increasing (**H-HH**). The factory setting is **L-H**.
  - For the combustible gas channel, it is not possible to set Alarm 1 or Alarm 2 higher than 60 %LEL.
  - In order to appropriately set the calibration gas value during a calibration, the Alarm 1 setting must be lower than the desired calibration value.
7. If you want to continue with the change, press and release POWER/ENTER to accept the setting.

If you want to exit this screen without saving any change to the alarms, press and release DISP/LOCK to return to the Channel Select Screen.

8. Repeat Step 4 - Step 7 for any additional changes you want to make to the selected channel's alarm points.
9. When you are done making changes to the selected channel, use SHIFT ▼ (PANIC) to move the cursor next to **ESCAPE** and press and release the POWER/ENTER button.
10. Repeat Step 3 - Step 9 for any changes you want to make to additional channels.
11. When you are done making changes to all channels, use SHIFT ▼ (PANIC) to move the cursor next to **ESCAPE**.
12. Press and release POWER/ENTER to return to the **ALARM SETTING** menu.

### ***Updating the Alarm Latching Setting***

With **ALARM LATCHING** set to **LATCHING** (factory setting), the GX-6000 remains in alarm condition until the alarm condition passes *and* the RESET button is pressed.

With **ALARM LATCHING** set to **SELF RESET**, the GX-6000 automatically resets an alarm when the alarm condition passes.

1. From the **ALARM SETTING** menu, place the cursor next to **ALARM LATCHING**.
2. Press and release POWER/ENTER. The Alarm Latching Screen appears.
3. Use ▲AIR or SHIFT ▼ (PANIC) to display the desired setting.
4. Press and release POWER/ENTER to save the setting and return to the **ALARM SETTING** menu.

### ***Updating the Alarm Silence Setting***

With **ALARM SILENCE** set to **ON** (factory setting), pressing and releasing the RESET button silences the buzzer when the GX-6000 is in alarm. The LEDs continue to flash, the vibrator continues to pulse, and the display continues to show the alarm. If you enter Display Mode during an alarm condition, the buzzer will be silenced but the LEDs will continue to flash and the vibrator will continue to pulse. If you return to Measuring Mode and there is still an alarm condition, the LEDs will continue to flash, the vibrator will continue to pulse, and the buzzer will remain off.

With **ALARM SILENCE** set to **OFF**, you cannot silence the buzzer. If you enter Display Mode during an alarm condition, the buzzer will not be silenced, the LEDs will continue to flash, and the vibrator will continue to pulse.

1. From the **ALARM SETTING** menu, place the cursor next to **ALARM SILENCE**.
2. Press and release **POWER/ENTER**. The Alarm Silence Option Screen appears.
3. Use **▲AIR** or **SHIFT ▼(PANIC)** to display the desired setting.
4. Press and release **POWER/ENTER** to save the setting and return to the **ALARM SETTING** menu.

### ***Returning to the Maintenance Mode Menu***

1. From the **ALARM SETTING** screen, place the cursor next to **ESCAPE**.
2. Press and release **POWER/ENTER**. The instrument will return to the main menu.

### **Turning the Pump On/Off Display Screen On and Off**

With **PUMP OFF DISP** set to **ON**, the Pump Off Screen appears in Display Mode and the user can turn off the pump in order to conserve battery power.

With **PUMP OFF DISP** set to **OFF** (factory setting), the Pump Off Screen does not appear in Display Mode and the user cannot turn the pump off.

1. From the main menu, place the cursor next to **PUMP OFF DISP**.
2. Press and release **POWER/ENTER**. The Pump Off Display Screen appears.
3. Use **▲AIR** or **SHIFT ▼(PANIC)** to display the desired setting.
4. Press and release **POWER/ENTER** to save the setting and return to the main menu.

### **Turning the User/Station ID Function On or Off**

With **ID DISPLAY** set to **ON**, the User ID and Station ID Screens display during start up and in Display Mode.

With **ID DISPLAY** set to **OFF** (factory setting), the User ID and Station ID Screens do not display during start up or in Display Mode.

1. From the main menu, place the cursor next to **ID DISPLAY**.
2. Press and release **POWER/ENTER**. The User and Station ID's Screen appears.
3. Use **▲AIR** or **SHIFT ▼(PANIC)** to display the desired setting.
4. Press and release **POWER/ENTER** to save the setting and return to the main menu.

### **Updating the Backlight Time Setting**

This setting indicates the length of time the LCD illuminates when you press any button. The minimum setting is **OFF**; the maximum setting is 255 seconds. The factory setting is 30 seconds.

1. From the main menu, place the cursor next to **BACK LIGHT TIME**.
2. Press and release **POWER/ENTER**. The Back Light Time Screen appears.
3. Use **▲AIR** and **SHIFT ▼(PANIC)** to adjust the time to the desired setting.
4. Press and release **POWER/ENTER** to save the setting and return to the main menu.

## Updating the Language Setting

This setting allows you to select the language for the GX-6000's user interface. The available choices are English (factory setting), Japanese, Italian, Spanish, German, French, Portuguese, Russian, and Korean.

1. From the main menu, place the cursor next to **LANGUAGE**.
2. Press and release POWER/ENTER. The Select Language Screen appears with the cursor in front of the current language.
3. Use ▲AIR or SHIFT ▼ (PANIC) to move the cursor in front of the desired language.

If you do not wish to select a new language, press and release DISP/LOCK. The unit will return to the main menu.

4. Press and release POWER/ENTER to save the new language setting and return to the main menu. The GX-6000's user interface will now be in the newly selected language.
5. If you select a language other than English, a prompt will appear during startup that allows you to change the language back to English if desired.

## Updating the Lunch Break Setting

With **LUNCH BREAK** set to **OFF** (factory setting), the GX-6000 automatically starts new TWA and PEAK reading collection and resets the time in operation at startup.

With **LUNCH BREAK** set to **ON**, the Lunch Break Screen displays during startup. From this screen, you can choose to continue accumulating TWA and PEAK readings and the time in operation from the last time the GX-6000 was used or start collecting new readings and reset the time in operation.

1. From the main menu, place the cursor next to **LUNCH BREAK**.
2. Press and release POWER/ENTER. The Lunch Break Screen appears.
3. Use ▲AIR or SHIFT ▼ (PANIC) to display the desired setting.
4. Press and release POWER/ENTER to save the setting and return to the main menu.

## Updating the Auto Zero Setting

This setting allows you to configure the GX-6000 so that a fresh air adjustment takes place automatically as part of the instrument startup sequence. If **AUTO ZERO** is set to **ON**, the GX-6000 performs a fresh air adjustment at the end of the startup sequence before entering Measuring Mode. The factory setting is **OFF**.

**WARNING:** *If the automatic fresh air feature is turned on, you must startup the GX-6000 in a known fresh air environment, an environment free of toxic or combustible gases and of normal oxygen content (20.9%). If this feature is on and the GX-6000 is started up in the presence of a target gas, the readings and alarms will not be accurate or reliable.*

1. From the main menu, place the cursor next to **AUTO ZERO**.
2. Press and release POWER/ENTER. The Fresh Air Adjust Screen appears.
3. Use ▲AIR or SHIFT ▼ (PANIC) to display the desired setting.
4. Press and release POWER/ENTER to save the setting and return to the main menu.



## Updating the Demand Zero Setting

With **DEMAND ZERO** set to **ON** (factory setting), you can manually perform a fresh air adjust in Measuring Mode by pressing the **▲ AIR** button.

With **DEMAND ZERO** set to **OFF**, you cannot manually perform a fresh air adjust in Measuring Mode.

1. From the main menu, place the cursor next to **DEMAND ZERO**.
2. Press and release **POWER/ENTER**. The Demand Zero Screen appears.
3. Use **▲AIR** or **SHIFT ▼ (PANIC)** to display the desired setting.
4. Press and release **POWER/ENTER** to save the setting and return to the main menu.

## Zero Follower Settings

The **ZERO FOLLOWER** setting is not intended for field adjustment. The default setting for most target gases is **ON**. The default setting for carbon dioxide channels and some configurations of non-standard toxic gas channels is **OFF**. The oxygen channel does not support this feature.

## Zero Suppression Settings

The **ZERO SUPPRESS** setting is not intended for field adjustment. The typical setting is 2% of full scale. The oxygen channel does not support this feature.

## Updating the Autoranging Setting

---

**NOTE:** Although **IR AUTO RANGE** always appears in Maintenance Mode, it only has an effect on instrument operation when an IR sensor is installed.

---

With **IR AUTO RANGE** set to **AUTO RANGE** (factory setting), the IR channel's gas reading will be displayed in %LEL until the gas level reaches 100 %LEL, or 5.0 %vol for methane. Once the gas reading is above 100 %LEL, it is displayed in %vol. Alarm points exist for the %LEL range but do not exist for the %vol range.

If **IR AUTO RANGE** is set to **LOW ONLY**, the IR channel's gas reading will only be displayed in %LEL up to 100 %LEL.

1. From the main menu, place the cursor next to **IR AUTO RANGE**.
2. Press and release **POWER/ENTER**. The IR Auto Range Screen appears.
3. Use **▲AIR** or **SHIFT ▼ (PANIC)** to move the cursor in front of the desired setting.
4. Press and release **POWER/ENTER** to save the setting and return to the main menu.

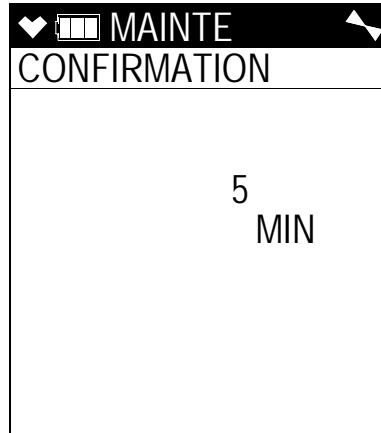
## Updating the Confirmation Alert Setting

With **CONFIRMATION** set to **ON**, the GX-6000 periodically double beeps and double flashes the LED arrays to verify that it is operating. The interval between the confirmation alert can be defined once you set **CONFIRMATION** to **ON**. The interval can be 1 - 60 minutes. The factory setting is 5 minutes.

With **CONFIRMATION** set to **OFF** (factory setting), the GX-6000 does not provide a confirmation alert.

1. From the main menu, place the cursor next to **CONFIRMATION**.
2. Press and release **POWER/ENTER**. The Confirmation Alert Screen appears.
3. Use **▲AIR** or **SHIFT ▼ (PANIC)** to display the desired setting.

4. Press and release **POWER/ENTER** to save the setting. If you set **CONFIRMATION** to **OFF**, the instrument will return to the main menu.
5. If you set **CONFIRMATION** to **ON**, the interval screen will appear



6. Use **▲AIR** or **SHIFT ▼ (PANIC)** to display the desired setting.
7. Press and release **POWER/ENTER** to save the setting and return to the main menu.

### Turning the Key Tone Noise On or Off

With **KEY TONE** set to **ON** (factory setting), the instrument will beep every time a button is pressed.

With **KEY TONE** set to **OFF**, the instrument will not beep when a button is pressed.

1. From the main menu, place the cursor next to **KEY TONE**.
2. Press and release **POWER/ENTER**. The Key Tone Screen appears.
3. Use **▲AIR** or **SHIFT ▼ (PANIC)** to display the desired setting.
4. Press and release **POWER/ENTER** to save the setting and return to the main menu.

### Turning Inert Mode On or Off

With **INERT MODE** set to **ON**, Inert Mode becomes an option in the Mode Select Screen when the instrument turns on. Normal Mode is still an option. See “Appendix G: Using the GX-6000 in Inert Mode” on page 205 for a description of Inert Mode.

With **INERT MODE** set to **OFF** (factory setting), selecting Inert Mode at startup is not an option.

1. From the main menu, place the cursor next to **INERT MODE**.
2. Press and release **POWER/ENTER**. The Inert Mode Screen appears.
3. Use **▲AIR** or **SHIFT ▼ (PANIC)** to display the desired setting.
4. Press and release **POWER/ENTER** to save the setting and return to the main menu.

### Updating the Leak Check/Bar Hole Mode Setting

With **L./B. MODE** set to **LEAK CHECK MODE/BAR HOLE MODE**, the Mode Select Screen appears when the unit is turned on. You are able to select from Normal Mode, Leak Check Mode, and Bar Hole Mode.

With **L./B. MODE** set to **BAR HOLE MODE**, the Mode Select Screen appears when the unit is turned on. You are able to select from Normal Mode and Bar Hole Mode.

With **L./B. MODE** set to **LEAK CHECK MODE**, the Mode Select Screen appears when the unit is turned on. You are able to select from Normal Mode and Leak Check Mode.

With **L./B. MODE** set to **OFF**, the Mode Select Screen does not appear when the unit is turned on and the unit goes into Normal Mode after the start up sequence.

This setting is factory set to **OFF** when a unit is shipped unless the instrument is ordered for bar hole measurement or leak checking use. See and “Appendix E: Using the GX-6000 in Leak Check Mode” for a discussion of Leak Check Mode. See “Appendix F: Using the GX-6000 in Bar Hole Mode” on page 198 for a discussion of Bar Hole Mode.

---

**NOTE:** If **LEAK CHECK MODE/BAR HOLE MODE** or **BAR HOLE MODE** is selected, Bar Hole Mode will only appear as a choice in the Mode Select Screen if an IR CH<sub>4</sub> or IR HC sensor is installed in the Smart Sensor 1 Position.

---

1. From the main menu, place the cursor next to **L./B. MODE**.
2. Press and release POWER/ENTER. The Leak Check/Bar Hole Mode Screen appears.
3. Use ▲AIR or SHIFT ▼(PANIC) to display the desired setting.
4. Press and release POWER/ENTER to save the setting and return to the main menu.

### **Setting the Bar Hole Measurement Time**

This setting indicates the length of time the unit will sample when a bar hole measurement is initiated in Bar Hole Mode. It can be set to 30 (factory setting), 45, or 60 seconds.

1. From the main menu, place the cursor next to **BAR HOLE TIME**.
2. Press and release POWER/ENTER. The Bar Hole Measuring Time Screen appears.
3. Use ▲AIR or SHIFT ▼(PANIC) to display the desired setting.
4. Press and release POWER/ENTER to save the setting and return to the main menu.

### **Updating the CO Display Setting**

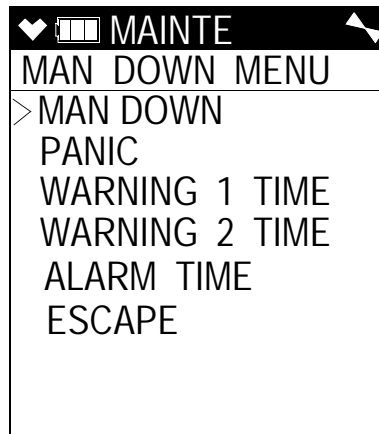
With **CO DISPLAY** set to **OFF** (factory setting), the CO channel is not displayed in Leak Check Mode. This setting has no effect on Normal Mode.

With **CO DISPLAY** set to **ON**, the CO channel will be displayed in Leak Check Mode but there will be no CO alarms. If any snap logs are taken while **CO DISPLAY** is set to **ON**, the CO reading is saved but will not be displayed during the snap log and cannot be seen by viewing snap log data at the instrument. However, the CO reading(s) can be viewed using the GX-6000 Datalogging Program.

1. From the main menu, place the cursor next to **CO DISPLAY**.
2. Press and release POWER/ENTER. The CO Display Screen appears.
3. Use ▲AIR or SHIFT ▼(PANIC) to display the desired setting.
4. Press and release POWER/ENTER to save the setting and return to the main menu.

## Updating the Man Down Settings

The **MAN DOWN** menu item in Maintenance Mode has a sub menu with 6 menu items: **MAN DOWN**, **PANIC**, **WARNING 1 TIME**, **WARNING 2 TIME**, **ALARM TIME**, and **ESCAPE**.



1. From the main menu, place the cursor next to **MAN DOWN**.
2. Press and release POWER/ENTER. The **MAN DOWN MENU** screen appears.

### **Updating the MAN DOWN Setting**

With **MAN DOWN** set to **ON**, the Man Down alarm can be triggered if the instrument detects no motion for the period of time defined in **WARNING 1 TIME**, **WARNING 2 TIME**, and **ALARM TIME** below.

With **MAN DOWN** set to **OFF** (factory setting), the Man Down alarm cannot be triggered.

See “Measuring Mode, Alarms” on page 41 for a description of the Man Down alarm.

1. From the **MAN DOWN MENU** screen, place the cursor next to **MAN DOWN**.
2. Press and release POWER/ENTER. The Man Down Screen appears.
3. Use ▲AIR or SHIFT ▼ (PANIC) to display the desired setting.
4. Press and release POWER/ENTER to save the setting and return to the **MAN DOWN MENU** screen.

### **Updating the PANIC Setting**

With **PANIC** set to **ON** (factory setting), a Panic Alarm can be manually initiated by holding down the SHIFT ▼ (PANIC) button.

With **PANIC** set to **OFF**, a Panic Alarm cannot be manually initiated.

See “Measuring Mode, Alarms” on page 41 for a description of the Panic Alarm.

1. From the **MAN DOWN MENU** screen, place the cursor next to **PANIC**.
2. Press and release POWER/ENTER. The Panic Screen appears.
3. Use ▲AIR or SHIFT ▼ (PANIC) to display the desired setting.
4. Press and release POWER/ENTER to save the setting and return to the **MAN DOWN MENU** screen.

### ***Updating the WARNING 1 TIME Setting***

The **WARNING 1 TIME** is the amount of time that has to pass between a Man Down detection and the first preliminary alarm. It can be set in 1 second increments from 10 - 120 seconds. The factory setting is 60 seconds. When setting the **WARNING 1 TIME**, keep in mind that **ALARM TIME ≥ WARNING 2 TIME ≥ WARNING 1 TIME**.

1. From the **MAN DOWN MENU** screen, place the cursor next to **WARNING 1 TIME**.
2. Press and release **POWER/ENTER**. The Warning 1 Time Screen appears.
3. Use **▲AIR** or **SHIFT ▼ (PANIC)** to display the desired setting.
4. Press and release **POWER/ENTER** to save the setting and return to the **MAN DOWN MENU** screen.

### ***Updating the WARNING 2 TIME Setting***

The **WARNING 2 TIME** is the amount of time that has to pass between a Man Down detection and the second preliminary alarm. It can be set in 1 second increments from 10 - 120 seconds. The factory setting is 75 seconds. When setting the **WARNING 2 TIME**, keep in mind that **ALARM TIME ≥ WARNING 2 TIME ≥ WARNING 1 TIME**.

1. From the **MAN DOWN MENU** screen, place the cursor next to **WARNING 2 TIME**.
2. Press and release **POWER/ENTER**. The Warning 2 Time Screen appears.
3. Use **▲AIR** or **SHIFT ▼ (PANIC)** to display the desired setting.
4. Press and release **POWER/ENTER** to save the setting and return to the **MAN DOWN MENU** screen.

### ***Updating the ALARM TIME Setting***

The **ALARM TIME** is the amount of time that has to pass between a Man Down detection and the main alarm. It can be set in 1 second increments from 10 - 120 seconds. The factory setting is 90 seconds. When setting the **ALARM TIME**, keep in mind that **ALARM TIME ≥ WARNING 2 TIME ≥ WARNING 1 TIME**.

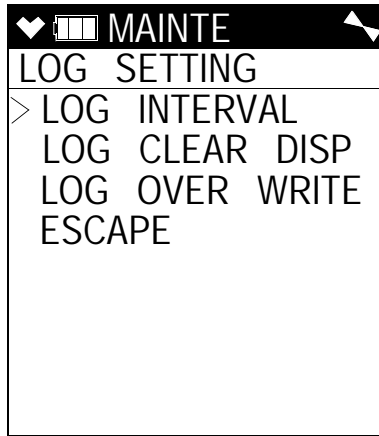
1. From the **MAN DOWN MENU** screen, place the cursor next to **ALARM TIME**.
2. Press and release **POWER/ENTER**. The Alarm Time Screen appears.
3. Use **▲AIR** or **SHIFT ▼ (PANIC)** to display the desired setting.
4. Press and release **POWER/ENTER** to save the setting and return to the **MAN DOWN MENU** screen.

### ***Returning to the Maintenance Mode Menu***

1. From the **MAN DOWN MENU** screen, place the cursor next to **ESCAPE**.
2. Press and release **POWER/ENTER**. The instrument will return to the main menu.

## Updating Datalogging Parameters

The **LOG SETTING** menu item in Maintenance Mode has a sub menu with 4 menu items: **LOG INTERVAL**, **LOG CLEAR DISP**, **LOG OVER WRITE**, and **ESCAPE**.



1. From the main menu, place the cursor next to **LOG SETTING**.
2. Press and release POWER/ENTER. The **LOG SETTING** menu appears.

### **Updating the Data Log Interval Setting**

This setting indicates how often the GX-6000 saves readings to the data logger. The following interval times can be selected: 10 minutes, 5 minutes (factory setting), 3 minutes, 2 minutes, 1 minute, 30 seconds, 20 seconds, or 10 seconds.

1. From the **LOG SETTING** screen, place the cursor next to **LOG INTERVAL**.
2. Press and release POWER/ENTER. The Log Interval Screen appears.
3. Use **▲AIR** or **SHIFT ▼(PANIC)** to display the desired setting.
4. Press and release POWER/ENTER to save the setting and return to the **LOG SETTING** screen.

### **Updating the Log Clear Display Setting**

With **LOG CLEAR DISP** set to **ON** (factory setting), the LOG CLEAR Screen appears in Display Mode (see “LOG CLEAR Screen” on page 56).

With **LOG CLEAR DISP** set to **OFF**, the LOG CLEAR Screen does not appear in Display Mode.

1. From the **LOG SETTING** screen, place the cursor next to **LOG CLEAR DISP**.
2. Press and release POWER/ENTER. The Log Clear Display Screen appears.
3. Use **▲AIR** or **SHIFT ▼(PANIC)** to display the desired setting.
4. Press and release POWER/ENTER to save the setting and return to the **LOG SETTING** screen.

### **Updating the Data Log Overwrite Setting**

With **LOG OVER WRITE** set to **ON** (factory setting), the GX-6000 writes over the oldest data with new data when the data logger memory is full.

With **LOG OVER WRITE** set to **OFF**, the GX-6000 stops saving data to the data logger when the data logger memory is full.

1. From the **LOG SETTING** screen, place the cursor next to **LOG OVER WRITE**.
2. Press and release POWER/ENTER. The Log Over Write Screen appears.

3. Use ▲AIR or SHIFT ▼(PANIC) to display the desired setting.
4. Press and release POWER/ENTER to save the setting and return to the LOG SETTING screen.

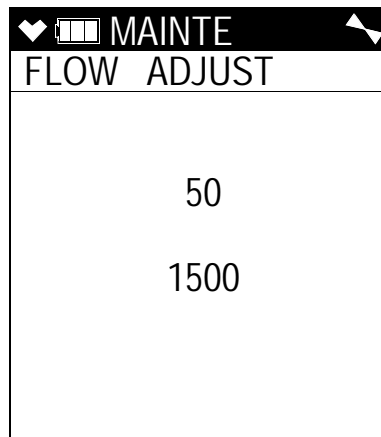
### **Returning to the Maintenance Mode Menu**

1. From the LOG SETTING screen, place the cursor next to ESCAPE.
2. Press and release POWER/ENTER. The instrument will return to the main menu.

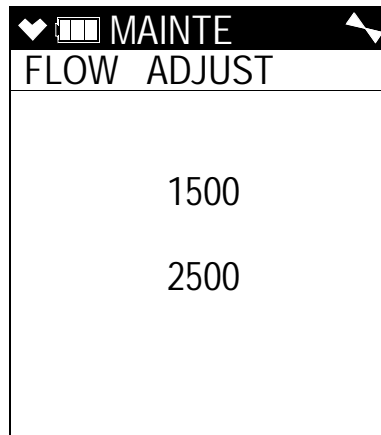
### **Adjusting the Low Flow Setpoint**

If your instrument repeatedly goes into low flow alarm and you have tried all of the recommendations in the Troubleshooting section, you may need to perform a low flow setpoint adjustment.

1. Use the ▲AIR or SHIFT ▼(PANIC) button to place the cursor next to FLOW ADJUST.
2. Press and release the POWER/ENTER button. The pump will turn off and the screen will display values that reflect the pump's current draw.



3. Use the ▲AIR and SHIFT ▼(PANIC) buttons to get a reading of approximately 1500 on the bottom value. When you have adjusted the value as close as you can, press and release the POWER/ENTER button.
4. The pump will turn on and two new values will be displayed. The top will be a reference value and the bottom will reflect the pump's current draw.



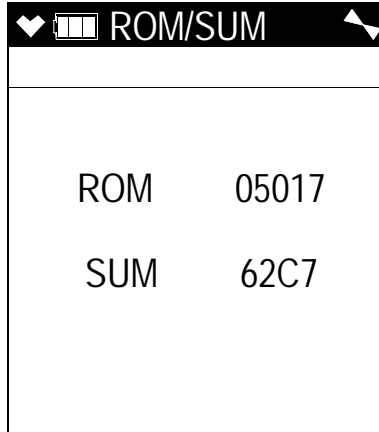
5. Connect a flow meter with a valve to the inlet of the instrument and adjust it to 0.2 LPM ± 0.1 LPM. This will be the low flow setpoint. You do not need to adjust anything at the instrument.

6. Press and release the POWER/ENTER button to save the changes and return to the main menu.

## Viewing the ROM/SUM of the Instrument

The **ROM/SUM** screen shows the firmware version that is loaded in the instrument and the firmware checksum.

1. Use the ▲AIR or SHIFT ▼(PANIC) button to place the cursor next to **ROM/SUM**.
2. Press and release the POWER/ENTER button. The ROM and checksum values for your unit will be displayed.



3. The first line displays the ROM number. The ROM number indicates the firmware version number. In the above example, the ROM number is 05017. The bottom line displays the firmware file's checksum, 62C7 in the above example.
4. Press and release the POWER/ENTER button again to return to the main menu.

## Turning the Password Function On or Off

With **PASSWORD** set to **ON** (factory setting), the GX-6000 prompts you for a password when you enter Maintenance Mode. The factory set password is 0006.

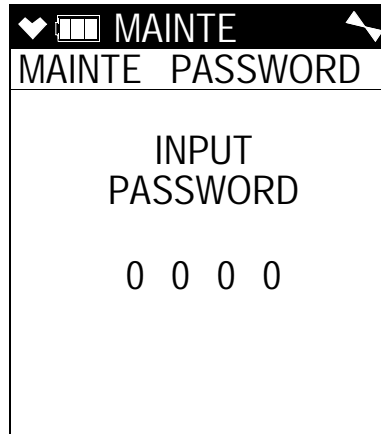
With **PASSWORD** set to **OFF**, no password is required to enter Maintenance Mode.

1. From the main menu, place the cursor in front of **PASSWORD**.
2. Press and release POWER/ENTER. The Password Protection Screen appears.
3. Use ▲AIR or SHIFT ▼(PANIC) to display the desired setting.
4. If you selected **OFF**, press and release POWER/ENTER to save the setting and return to the main menu.

If you selected **ON**, continue with Step 5.



5. Press and release POWER/ENTER. The Set Password Screen appears. 0000 is at the bottom of the screen with the first 0 flashing.



6. Use ▲AIR or SHIFT ▼ (PANIC) to display a number from 0 to 9.
7. Press and release POWER/ENTER to enter the selection and advance to the next number.
8. Repeat Step 6 and Step 7 to select the remaining numbers. When you press and release POWER/ENTER to enter the last number, the password is saved and you return to the main menu.

## Restoring the Default Settings

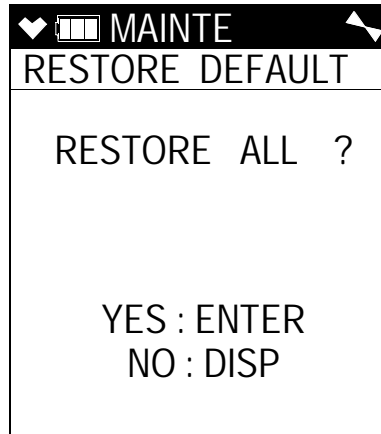
Each of the GX-6000 setup parameters, such as the auto calibration values, zero and span settings, or parameters in Maintenance Mode, has a default setting. For the items in Maintenance Mode, the default settings are the same as the standard factory settings. If you want to return the GX-6000 to its default configuration, it is possible to do so by using the Default Settings menu item in Maintenance Mode. Returning the GX-6000 to its default configuration can be useful if various setup parameters have been changed in the field and you want to return the GX-6000 to its original configuration as shipped from the factory.

There are some special GX-6000 configurations that may have a different default configuration than the standard. Consult RKI Instruments, Inc. for information regarding non-standard default configurations.

**WARNING:** *When the GX-6000 is restored to its default configuration, the zero and span values for each channel are reset. You must recalibrate all active channels if you restore the GX-6000 to its default configuration.*

1. From the main menu, place the cursor in front of **RESTORE DEFAULT**.

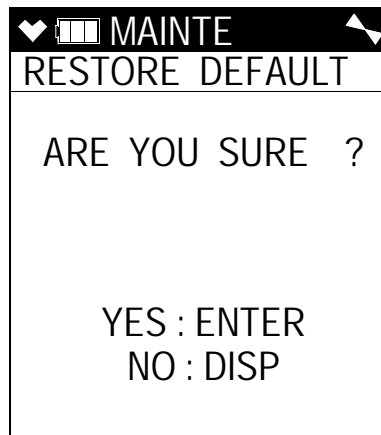
2. Press and release POWER/ENTER. The Restore All? Screen appears asking if you want to restore the default configuration.



3. If you do not want to restore the default configuration, press and release DISP/LOCK to return to the main menu.

If you do want to restore the default configuration, continue with Step 4.

4. Press and release the POWER/ENTER button. A screen appears asking you to confirm that you want to restore the default configuration.



5. Press and release the POWER/ENTER button. The screen will indicate that the default configuration has been restored and return to the main menu.

## Exiting Maintenance Mode

1. From the main menu, place the cursor in front of **START MEASURE** at the bottom of the menu.
2. Press and release POWER/ENTER.
3. The unit will begin its start-up sequence.

## Appendix B: Maintenance Mode 2

---

### Overview

This appendix describes the GX-6000 in Maintenance Mode 2. The GX-6000 is factory-set to suit most applications. Update settings in Maintenance Mode 2 only if required for your specific application. A description of the Maintenance Mode 2 items is shown in Table 18 below.

**Table 18: Maintenance Mode 2 Menu Items**

Menu Item (Page # of Description)	Description
GAS COMB (pg.166)	Turn channels on or off
HC SELECT (pg.167)	Set the catalytic LEL channel's detection gas
START MEASURE (pg.167)	Enter Measuring Mode

---

### Tips for Using Maintenance Mode 2

- When in the main menu, the cursor (>) indicates which menu item will be selected if the POWER/ENTER button is pressed and released.
- Use the SHIFT ▼ (PANIC) button to move the cursor down through the main menu and submenu items, and to lower values or change the setting in a specific option.
- Use the ▲AIR button to move the cursor up through the main menu and submenu items, and to raise values or change the setting in a specific option.
- Use the POWER/ENTER button to enter a menu item with the cursor next to it and to enter and save settings during programming.
- An adjustable parameter that is flashing can be adjusted with the ▲AIR and SHIFT ▼ (PANIC) buttons.
- Press the DISP/LOCK button while in a screen where you are entering or updating parameters to exit the screen without saving any changes. You can also use the DISP/LOCK button to back out of submenus and return to the main menu.

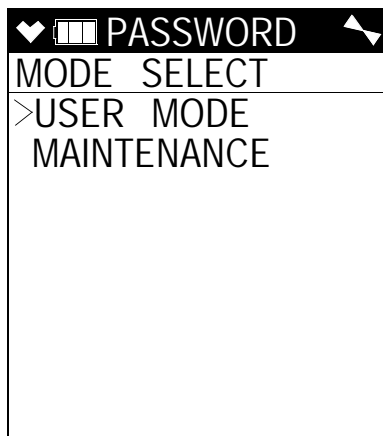
## Using Maintenance Mode 2

**WARNING:** *The GX-6000 is not in operation as a gas detector while in Maintenance Mode 2.*

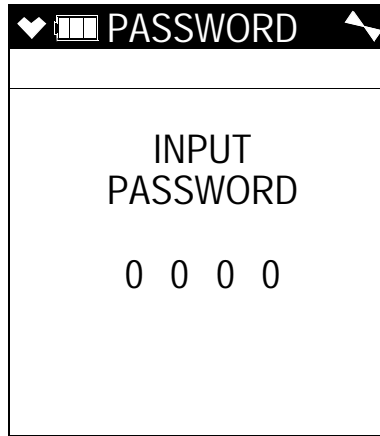
1. Take the GX-6000 to a non-hazardous location and turn it off if it is on.
2. Press and hold the ▲AIR and SHIFT ▼ (PANIC) buttons, then press and hold the POWER/ENTER button. When you hear a beep, release the buttons.
3. The screen that appears will depend on the setting of User Mode's **PASSWORD** item.

If User Mode's **PASSWORD** is set to **OFF** (factory setting), continue with Step 4.

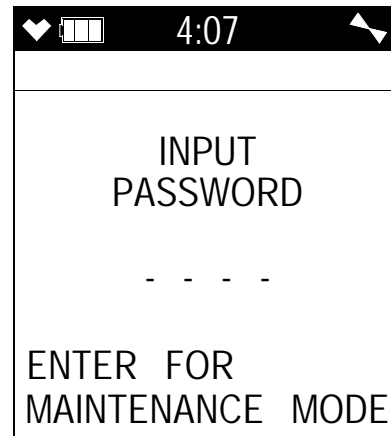
If User Mode's **PASSWORD** is set to **ON**, continue with Step 6.



User **PASSWORD OFF**  
Maint. **PASSWORD ON**  
or **OFF**



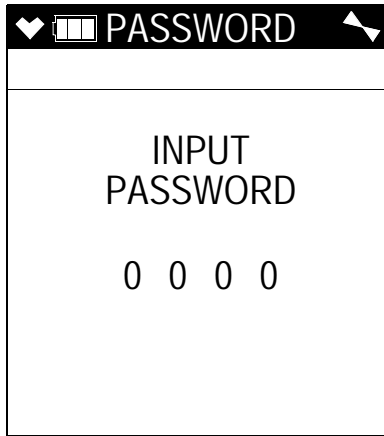
User **PASSWORD ON**  
Maint. **PASSWORD ON**



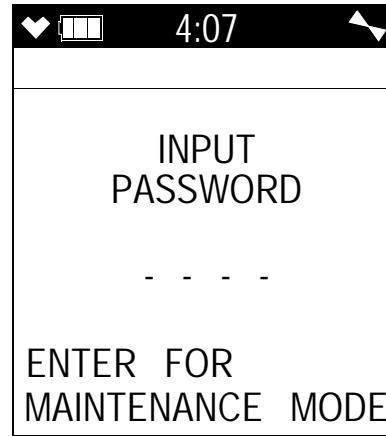
User **PASSWORD ON**  
Maint. **PASSWORD OFF**

4. If User Mode's **PASSWORD** has been set to **OFF**, the Mode Select screen will appear, prompting you to choose the mode you'd like to enter.
5. Use the ▲AIR and SHIFT ▼ (PANIC) buttons to put the cursor in front of **MAINTENANCE** and press and release the POWER/ENTER button. A password screen will appear. Continue to Step 7.
6. If User Mode's **PASSWORD** has been set to **ON**, a password screen will appear.

7. The appearance of the password screen will be affected by Maintenance Mode's **PASSWORD** setting but the procedure for entering Maintenance Mode 2 is unaffected.

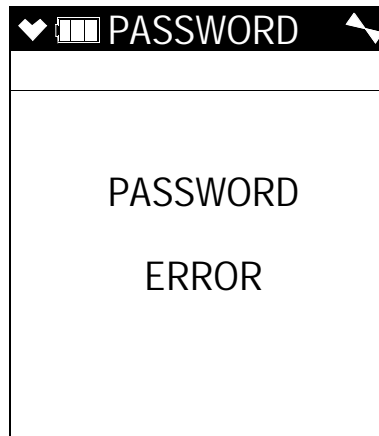


Maint. **PASSWORD** set to **ON**



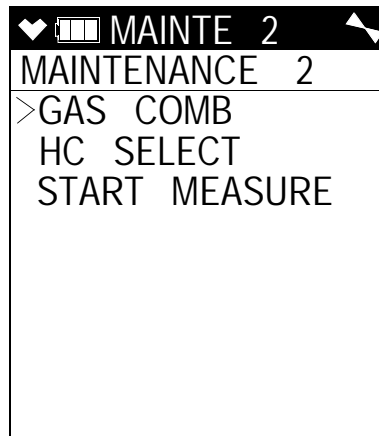
Maint. **PASSWORD** set to **OFF**

8. Enter the password for Maintenance Mode 2 by using the ▲AIR and SHIFT ▼ (PANIC) buttons to select each password number and then pressing and releasing the POWER/ENTER button to enter it and move on to the next number until all of the numbers are entered. The password for Maintenance Mode 2 is 2014.
9. If you enter an incorrect password, an error screen will appear.



You must turn the unit off and reenter Maintenance Mode 2 using the correct password.

10 . The main menu displays.



11 . Use the ▲AIR or SHIFT ▼ (PANIC) button to move the cursor up and down through the menu items.

### Changing the Gas Combination

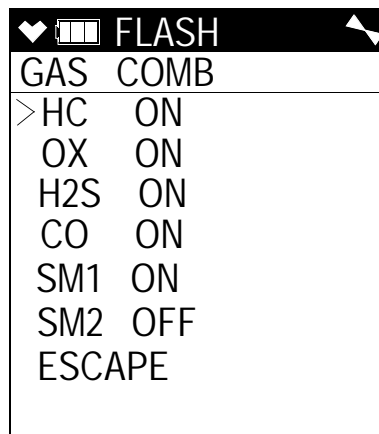
The **GAS COMB** menu item allows you to turn channels on and off.

---

**NOTE:** A smart sensor channel cannot be turned off if the smart sensor is still installed. If you want to turn off a smart sensor's channel, you must first remove the smart sensor and replace it with a dummy sensor.

---

- 1 . From the main menu, place the cursor next to **GAS COMB**.
- 2 . Press and release POWER/ENTER. The Gas Combination Screen appears and all channels are displayed.



- 3 . Move the cursor next to the channel you want to update. Press and release POWER/ENTER. The channel's current on/off setting will begin to flash.
- 4 . Use ▲AIR and SHIFT ▼ (PANIC) to change the on/off setting.
- 5 . If you want to continue with the change, press and release POWER/ENTER to accept the setting.

If you want to exit this screen without saving the change, press and release DISP/LOCK to return to the main menu.

- 6 . Repeat Step 3 - Step 5 for any changes you want to make to additional channels.

7. When you are done making changes to all channels, use **SHIFT ▼ (PANIC)** to move the cursor next to **ESCAPE**.
8. Press and release **POWER/ENTER** to return to the main menu.

### **Changing the Catalytic LEL Channel's Target Gas**

The **HC SELECT** menu item allows you to change the catalytic LEL channel's target gas.

With **HC SELECT** set to **CH4** (factory setting), the catalytic LEL channel should be calibrated to methane.

With **HC SELECT** set to **HC**, the catalytic LEL channel can be calibrated to a desired combustible gas.

1. From the main menu, place the cursor next to **HC SELECT**.
2. Press and release **POWER/ENTER**. The HC Select Screen appears.
3. Use **▲AIR** or **SHIFT ▼ (PANIC)** to display the desired setting.
4. Press and release **POWER/ENTER** to save the setting and return to the main menu.

### **Exiting Maintenance Mode 2**

1. From the main menu, place the cursor in front of **START MEASURE** at the bottom of the menu.
2. Press and release **POWER/ENTER**.
3. The unit will begin its start-up sequence.

# Appendix C: ESS-03 Toxic Sensors

## Overview

The ESS-03 sensors are used to monitor levels of a variety of toxic gases. This appendix describes the GX-6000's ESS-03 sensors. It also includes instructions to replace an ESS-03 sensor. Table 19 below lists the available ESS-03 sensors.

**Table 19: ESS-03 Sensor Specifications**

Target Gas	Detection Range	Reading Increment	Alarm 1 Factory Setting	Alarm 2 Factory Setting	STEL	TWA
Ammonia (NH <sub>3</sub> )	0 - 400 ppm	0.5 ppm	25 ppm	50 ppm	35 ppm	25 ppm
Chlorine (Cl <sub>2</sub> )	0 - 10.0 ppm	0.05 ppm	0.50 ppm	1.00 ppm	1.00 ppm	0.50 ppm
Hydrogen Cyanide (HCN)	0 - 15.0 ppm	0.1 ppm	5.00 ppm	10.0 ppm	4.7 ppm	N/A
Nitrogen Dioxide (NO <sub>2</sub> )	0 - 20.00 ppm	0.05 ppm	3.00 ppm	6.00 ppm	N/A	3.00 ppm
Sulphur Dioxide (SO <sub>2</sub> )	0 - 99.90 ppm	0.05 ppm	2.00 ppm	5.00 ppm	5.00 ppm	2.00 ppm

**NOTE:** If you are attempting to detect chlorine, be sure the hose/probe does not have a particle filter installed. Also be sure that the hose is not longer than 30 feet.

## Description

The ESS-03 is a smart sensor that stores sensor parameters including the target gas, detection range, alarm points, and calibration settings in its memory. So a sensor can be calibrated at the factory and shipped as a replacement sensor without the need to calibrate the sensor when it is installed as long as it is installed during the sensor's valid calibration period which is typically 3 months. In addition, you can change an existing ESS-03 channel from one type of ESS-03 sensor to another and the GX-6000 will automatically load all the sensor parameters and configure the ESS-03 channel for the new sensor. See "Replacing the ESS-03 Sensor or Changing Sensor Type" on page 176 for instructions to replace or change an ESS-03 sensor.

The ESS-03 sensor is a cylindrical sensor with a diffusion opening on the front and a connector on the back. The ESS-03 sensor is installed in one of the two smart sensor sockets and is held in place by the sensor gasket and the flow chamber.



---

## Interference

Although the GX-6000 can support up to two ESS-03 sensors, many combinations are impractical for various reasons including sensor cross sensitivity to other gases.

The table below indicators some of the gases that will cause an increased gas reading for the affected sensor. For example, if you are attempting to detect HCN but H<sub>2</sub> is also present, the instrument's HCN reading will be higher than the environment's actual HCN level.

**Table 20: Positive Interference**

Sensor	Affected By:
Cl <sub>2</sub>	<ul style="list-style-type: none"><li>• HCl</li><li>• SO<sub>2</sub></li></ul>
HCN	<ul style="list-style-type: none"><li>• H<sub>2</sub></li><li>• SO<sub>2</sub></li></ul>
SO <sub>2</sub>	<ul style="list-style-type: none"><li>• H<sub>2</sub></li></ul>

The table below indicates some of the gases that will cause a negative response and a decreased reading for the affected sensor. For example, if you are attempting to detect SO<sub>2</sub> but NO<sub>2</sub> is also present, the instrument's SO<sub>2</sub> reading will be lower than the environment's actual SO<sub>2</sub> level.

**Table 21: Negative Interference**

Sensor	Affected By:
HCN	<ul style="list-style-type: none"><li>• NO<sub>2</sub></li></ul>
NH <sub>3</sub>	<ul style="list-style-type: none"><li>• HCl</li><li>• NO<sub>2</sub></li></ul>
NO <sub>2</sub>	<ul style="list-style-type: none"><li>• CO</li><li>• SO<sub>2</sub></li></ul>
SO <sub>2</sub>	<ul style="list-style-type: none"><li>• NO<sub>2</sub></li></ul>

---

## Start Up and Normal Operation

For instructions to startup and use a GX-6000 that includes an ESS-03 sensor, reference “Start Up” on page 25, “Measuring Mode, Normal Operation” on page 35, and “Measuring Mode, Alarms” on page 41. Follow these instructions keeping the following special considerations in mind:

- Some of the gases that are monitored with an ESS-03 may be absorbed in small amounts in the longer GX-6000 sample hoses. When detecting gases other than chlorine, do not use sample hoses that are longer than 50 feet without consulting RKI Instruments, Inc. When detecting chlorine, do not use sample hoses that are longer than 30 feet. If using a hose and probe to monitor toxic gases, be sure to calibrate the ESS-03 sensor with the hose and probe attached so that the calibration reflects any absorption that may be occurring.
- If you are attempting to detect chlorine, be sure the hose/probe does not have a particle filter installed.
- If your GX-6000 has more than one ESS-03 sensor installed, it is possible that both sensors will respond to some of the same gases at varying levels. Make sure you understand any issues like this that may exist in your particular instrument.
- The SO<sub>2</sub> and HCN ESS-03 sensors include an H<sub>2</sub>S scrubber disk inside the sensor face. The H<sub>2</sub>S scrubber disk prevents false SO<sub>2</sub> and HCN readings by removing any H<sub>2</sub>S that would cause a response on the SO<sub>2</sub> and HCN sensors.

---

## ESS-03 Calibration

An ESS-03 channel can be calibrated using the auto calibration method or the single calibration method.

---

**NOTE:** ESS-03 calibration must be done with the hose and probe attached. If you are calibrating a chlorine sensor, be sure the hose/probe does not have a particle filter installed.

---

### Calibrating the ESS-03 Sensor Using Auto Calibration

The calibration instructions below assume a standard 4 + high range PID + ESS-03 instrument configuration.

There are several ways to calibrate a standard 4 + high range PID + ESS-03 instrument:

- separate cylinders for the standard 4 sensors, high range PID sensor, and ESS-03 sensor (3 cylinders total)
- 5-gas cylinder for the standard 4 sensors plus high range PID sensor and a separate cylinder for the ESS-03 sensor (2 cylinders total)
- separate cylinder for the high range PID sensor and a 5-gas cylinder for standard 4 sensors plus ESS-03 sensor (2 cylinders total)

See “Calibration Supplies and Equipment” on page 71 for a description of the necessary calibration supplies. See Table 23 on page 178 for available cylinders. Make sure your calibration cylinder is appropriate for the ESS-03 detection range.

---

**NOTE:** RKI Instruments, Inc. recommends that you dedicate a regulator for use with chlorine ( $\text{Cl}_2$ ) gas and that you do not use that dedicated regulator for any other gases, particularly hydrogen sulfide ( $\text{H}_2\text{S}$ ).

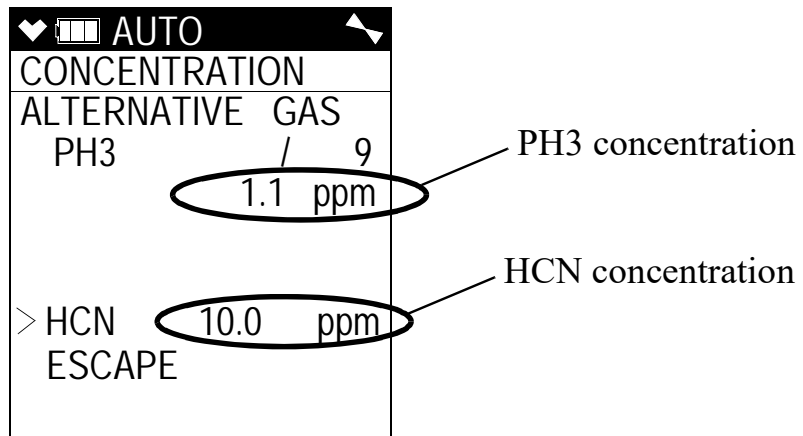
---

1. To calibrate the standard 4 sensors and/or the high range PID sensor, follow the instructions outlined in “Calibrating Using the Auto Calibration Method” on page 72.
- 

**NOTE:** Be sure to calibrate the ESS-03 sensor with the hose and probe attached.

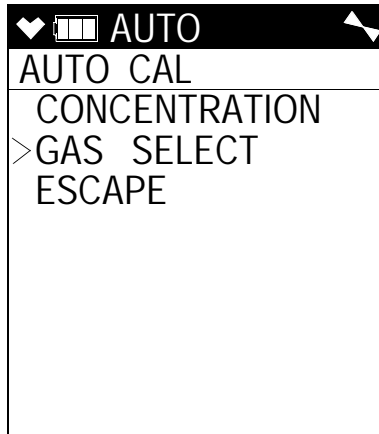
---

2. When you review the auto calibration values, confirm that the ESS-03’s auto calibration gas value matches the calibration cylinder.
  - a. If you need to change an HCN channel’s auto calibration value, the procedure is slightly different since  $\text{PH}_3$  can be used to calibrate the HCN channel. When you move the cursor to HCN in the Concentration Screen and then press and release the POWER/ENTER button, the Alternative Gas Screen will appear. The HCN concentration will be flashing.



- b. Use the ▲AIR and SHIFT ▼(PANIC) buttons to change the HCN concentration. As the HCN concentration changes, the  $\text{PH}_3$  concentration will also change. If you are using HCN to calibrate the HCN sensor, adjust the HCN concentration until it matches the concentration listed on your cylinder. If you are using  $\text{PH}_3$  to calibrate the HCN sensor, adjust the HCN concentration until the  $\text{PH}_3$  concentration matches the concentration listed on your cylinder.

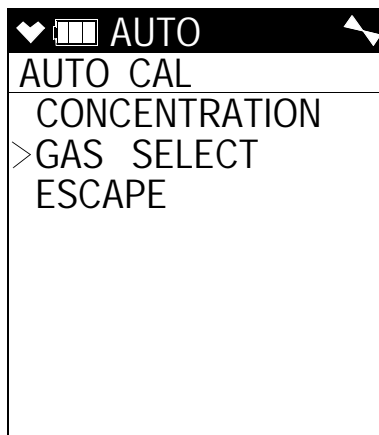
- 3 . After you have completed Step 30 on page 82, the Auto Cal Menu will be displayed. Continue with Step 4 below.



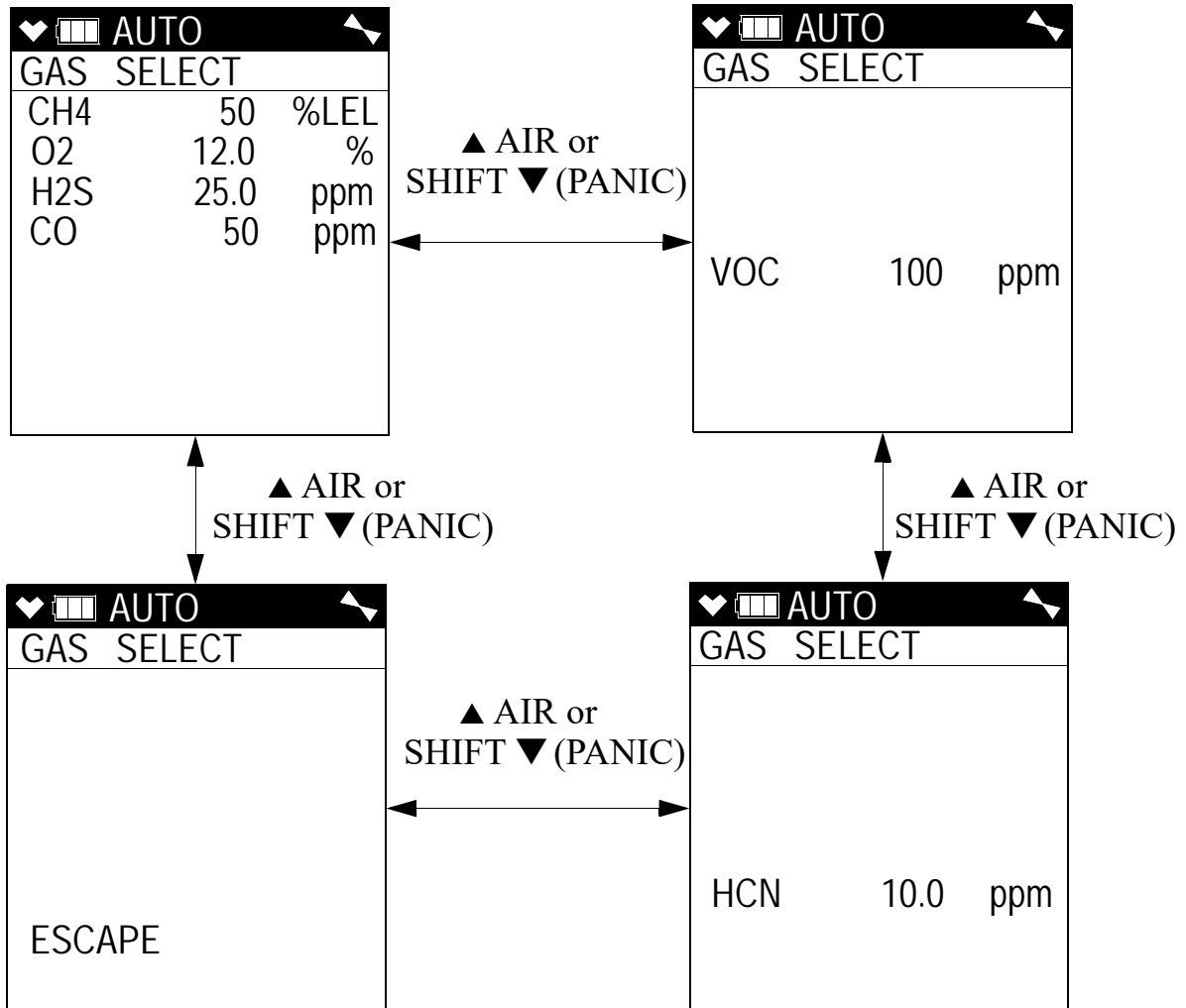
- 4 . If you were using a 5-gas (standard 4-gas + ESS-03) calibration cylinder to calibrate the standard 4 sensors, continue to Step 5.

If you were using a 5-gas (standard 4-gas + high range PID) calibration cylinder or a 4-gas calibration cylinder/high range PID-only calibration cylinder combination to calibrate the standard 4 sensors and/or the high range PID sensor:

- a. Remove the tubing from the rigid tube on the probe.
  - b. Unscrew the 5-gas (standard 4-gas + high range PID), 4-gas cylinder, or high range PID cylinder from the regulator.
  - c. Screw the ESS-03 calibration cylinder onto the demand flow regulator. Continue with Step 6.
- 5 . If you were using a 5-gas (standard 4-gas + ESS-03) calibration cylinder to calibrate the standard 4 sensors:
    - a. Leave the tubing connected to the rigid tube on the probe. Continue with Step 6.
  - 6 . Use the ▲AIR and SHIFT ▼(PANIC) buttons to move the cursor next to **GAS SELECT**.

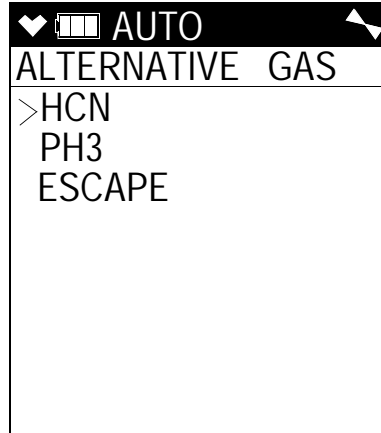


- Press and release the POWER/ENTER button. The first of the Gas Select Screens, the standard four sensors screen, will be displayed. In addition to the standard four sensors screen, there is a separate screen for each installed smart sensor, and an **ESCAPE** screen that will take you back to the Auto Cal menu. Use the **▲AIR** and **SHIFT ▼(PANIC)** buttons to scroll through the different screens.

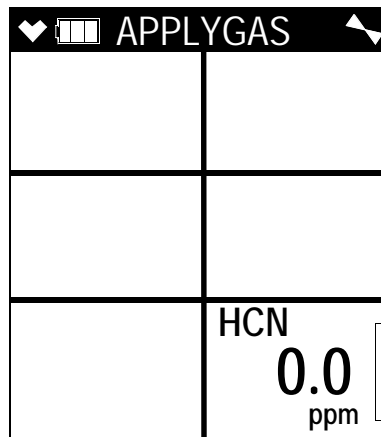


- With the ESS-03 channel's Gas Select Screen displayed, press and release the POWER/ENTER button.
- If you are calibrating anything other than an HCN sensor, continue to Step 12.

- 10 . If you are calibrating an HCN sensor, an Alternative Gas screen will appear. The HCN sensor can be calibrated using HCN or PH<sub>3</sub>. This screen allows you to select which gas you want to use.



- 11 . Use the ▲AIR and SHIFT ▼ (PANIC) buttons to move the cursor in front of the gas you will use for calibration then press and release the POWER/ENTER button.
- 12 . The Calibration In Process Screen for the ESS-03 channel will display. **APPLYGAS** and the gas reading will be flashing.



If you do not want to proceed with the calibration, press and release the DISP/LOCK button to return to the Gas Select Screen.

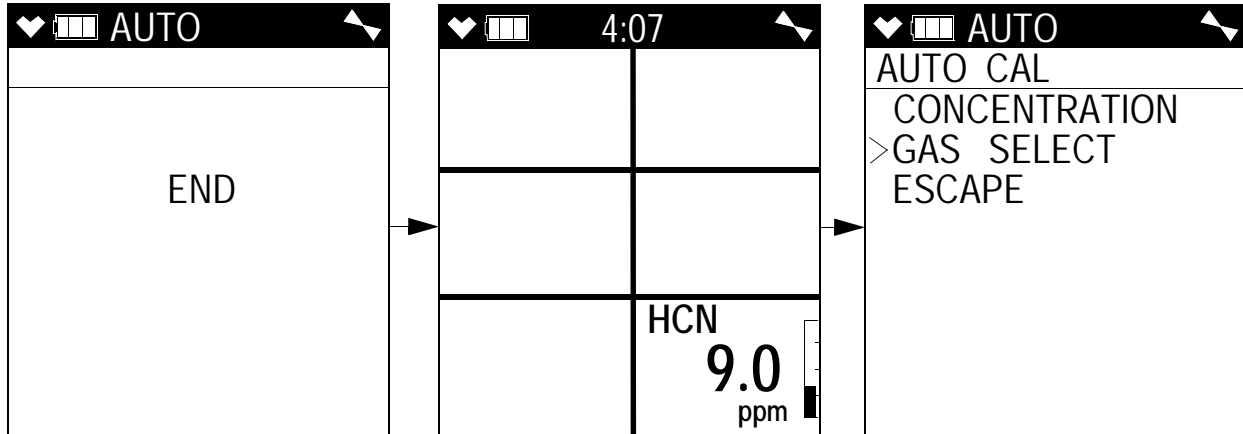
If you do want to continue with the calibration, proceed to the next step.

- 13 . If you are using a 5-gas (standard 4-gas + ESS-03) calibration cylinder, continue with Step 14.

If you are using an ESS-03 only calibration cylinder:

- a. Connect the tubing from the regulator to the rigid tube on the probe. Allow the GX-6000 to draw gas for one minute.
- b. Press and release the POWER/ENTER button to set the span adjustment for the ESS-03 channel to the programmed value. Continue with Step 15.

- 14 . If you are using a 5-gas (standard 4-gas + ESS-03) calibration cylinder:
  - a. Since calibration gas was flowing to the ESS-03 sensor while the standard 4 channels were being calibrated, the ESS-03 sensor reading should be stable and ready for adjustment.
  - b. Press and release the POWER/ENTER button to set the span adjustment for the ESS-03 channel to the programmed value. Continue with Step 15.
- 15 . If the ESS-03 channel passed calibration, the following screen sequence occurs.



If the ESS-03 channel cannot be adjusted to the proper value, a screen displays that indicates a calibration failure and indicates that the ESS-03 sensor failed to calibrate.



The buzzer and alarm LEDs activate in a double pulsing pattern. Press and release the RESET button to reset the alarm and continue to the Auto Cal Menu. Attempt to calibrate the ESS-03 channel again. If the failure continues, investigate the cause. See “Troubleshooting” on page 100.

- 16 . Disconnect the tubing from the probe.
- 17 . Unscrew the demand flow regulator from the calibration cylinder.
- 18 . Use the SHIFT ▼ (PANIC) button to move the cursor next to **ESCAPE**, then press and release the POWER/ENTER button to return to the Calibration Mode Menu.
- 19 . Use the SHIFT ▼ (PANIC) button to place the cursor next to the **NORMAL MODE** menu option, then press and release the POWER/ENTER button to return to Measuring Mode.

## Calibrating the ESS-03 Sensor Using Single Calibration

See “Performing a Span Adjustment” on page 75 for instructions to calibrate the ESS-03 using single calibration.

---

**NOTE:** RKI Instruments, Inc. recommends that you dedicate a regulator for use with chlorine ( $\text{Cl}_2$ ) gas and that you do not use that dedicated regulator for any other gases, particularly hydrogen sulfide ( $\text{H}_2\text{S}$ ).

---

## ESS-03 Bump Testing

See “Performing a Bump Test” on page 88 for instructions to perform a bump test.

---

**NOTE:** RKI Instruments, Inc. recommends that you dedicate a regulator for use with chlorine ( $\text{Cl}_2$ ) gas and that you do not use that dedicated regulator for any other gases, particularly hydrogen sulfide ( $\text{H}_2\text{S}$ ).

---

## Replacing the ESS-03 Sensor or Changing Sensor Type

When replacing a sensor, you may either replace it with another of the same sensor or you may install a different ESS-03 sensor. If a different one is installed, the GX-6000 will load the sensor parameters and configure the ESS-03 channel for the new sensor.

1. Follow the instructions listed in “Replacing a Sensor” on page 116 keeping the following exception in mind:
  - A bias board is attached to the bottom of replacement ESS-03 sensors and must be removed before installing the sensor in the GX-6000. Properly dispose of the bias board once the sensor has been installed.

Be sure that the new sensor is installed in the same position as the old sensor and that the following sensor priority for the smart sensor 1 position is maintained.

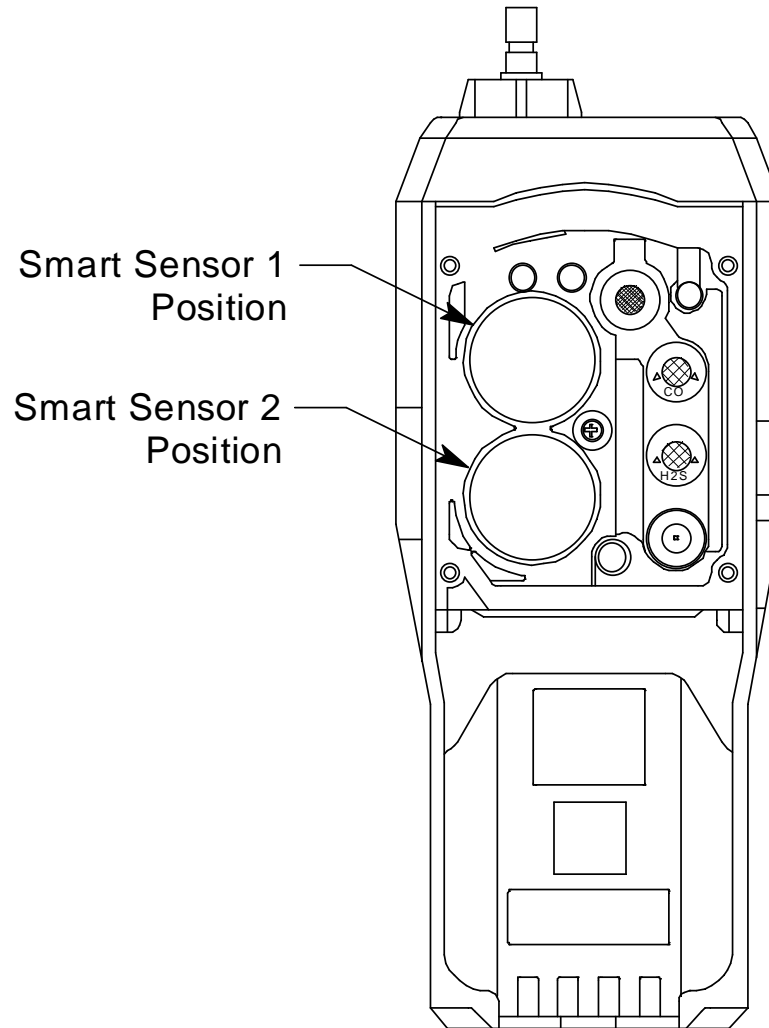
**Table 22: Priority for Smart Sensor 1 Position**

High Priority ↓ Low Priority	10.6 eV low range PID
	10.0 eV/benzene PID
	11.7 eV PID
	10.6 eV high range PID
	ESS-03 Chlorine
	ESS-03 Ammonia
	IR and other ESS-03 sensors

For example, if your instrument is a 4-gas + ESS-03  $\text{Cl}_2$  + ESS-03  $\text{NH}_3$ , the  $\text{Cl}_2$  sensor should be in the smart sensor 1 position and the  $\text{NH}_3$  sensor should be in the smart sensor



2 position. If your instrument is a 4-gas + ESS-03 NH<sub>3</sub>, the NH<sub>3</sub> sensor should be in the smart sensor 1 position and a dummy sensor should be installed in the smart sensor 2 position. See the figure below for the location of the smart sensor 1 and 2 positions.



**Figure 39: Smart Sensor Positions**

## Parts List

**Table 23: ESS-03 GX-6000 Parts List**

Part Number	Description
80-0006-XXP	Sample hose with integral probe, with hydrophobic filter and particle filter, no scrubber section. <b>For use with NH<sub>3</sub>, HCN, NO<sub>2</sub>, and SO<sub>2</sub> sensors.</b> Replace "XX" with length in feet. 3 foot hose is standard. Available lengths for the GX-6000 are 3, 5, 10, 15, 20, 25, 30, 35, 40, 45, and 50 feet.
80-0006-XXP-01	Sample hose with integral probe, no particle filter, no scrubber section. <b>For use with Cl<sub>2</sub> sensor.</b> Replace "XX" with length in feet. 3 foot hose is standard. Available lengths for the GX-6000 are 3, 5, 10, 15, 20, 25, and 30 feet.
80-0172	Probe, with hydrophobic filter and particle filter, no scrubber section. <b>For use with NH<sub>3</sub>, HCN, NO<sub>2</sub>, and SO<sub>2</sub> sensors.</b>
80-0172-01	Probe, with hydrophobic filter, no particle filter, no scrubber section. <b>For use with Cl<sub>2</sub> sensor.</b>
81-0142RK-02	Calibration cylinder, 5-gas (SO <sub>2</sub> , CH <sub>4</sub> , O <sub>2</sub> , H <sub>2</sub> S, CO), 58-liter aluminum
81-0142RK-04	Calibration cylinder, 5-gas (SO <sub>2</sub> , CH <sub>4</sub> , O <sub>2</sub> , H <sub>2</sub> S, CO), 34-liter aluminum
81-0170RK-02	Calibration cylinder, 5 ppm SO <sub>2</sub> in nitrogen, 58 liter
81-0170RK-04	Calibration cylinder, 5 ppm SO <sub>2</sub> in nitrogen, 34 liter
81-0176RK-02	Calibration cylinder, 25 ppm NH <sub>3</sub> in nitrogen, 58 liter
81-0176RK-04	Calibration cylinder, 25 ppm NH <sub>3</sub> in nitrogen, 34 liter
81-0182RK-02	Calibration cylinder, 5 ppm NO <sub>2</sub> in air, 58 liter
81-0182RK-04	Calibration cylinder, 5 ppm NO <sub>2</sub> in air, 34 liter
81-0190RK-02	Calibration cylinder, 5 ppm Cl <sub>2</sub> in nitrogen, 58 liter
81-0190RK-04	Calibration cylinder, 5 ppm Cl <sub>2</sub> in nitrogen, 34 liter
81-0196RK-02	Calibration cylinder, 10 ppm HCN in nitrogen, 58 liter
81-0196RK-04	Calibration cylinder, 10 ppm HCN in nitrogen, 34 liter
ESS-03DH-HCN	Hydrogen cyanide sensor, 0 - 15.0 ppm
ESS-03DH-NO2	Nitrogen dioxide sensor, 0 - 20.00 ppm
ESS-03DH-SO2	Sulfur dioxide sensor, 0 - 99.90 ppm
ESS-B332-NH3	Ammonia sensor, 0 - 400 ppm
ESS-B335-CL2	Chlorine sensor, 0 - 10.0 ppm

# Appendix D: Infrared Sensors

## Overview

The infrared sensors are used to monitor levels of methane, combustible gas, and carbon dioxide. This appendix describes the GX-6000's infrared sensors and includes instructions to use a GX-6000 that has one or more infrared sensors installed. It also includes instructions to replace an infrared sensor. The table below lists the available infrared sensors along with their specifications.

**Table 24: Infrared Sensor Specifications**

Sensor	Range	Increment	Alarm 1	Alarm 2	STEL	TWA
IR CO <sub>2</sub>	0 - 10.00 %vol	0.02 %vol	0.50 %vol	3.00 %vol	3.00 %vol	0.50 %vol
	0 - 10,000 ppm	20 ppm	5,000 ppm	N/A	N/A	5,000 ppm
IR HC %LEL	0 - 100 %LEL HC	1 %LEL	10 %LEL	50 %LEL	N/A	N/A
IR HC Autoranging	0 - 100 %LEL HC	1 %LEL	10 %LEL	50 %LEL	N/A	N/A
	2.0 - 30.0 %vol HC	0.5 %vol	N/A	N/A	N/A	N/A
IR CH <sub>4</sub> %LEL	0 - 100 %LEL CH <sub>4</sub>	1 %LEL	10 %LEL	50 %LEL	N/A	N/A
IR CH <sub>4</sub> Autoranging	0 - 100 %LEL CH <sub>4</sub>	1 %LEL	10 %LEL	50 %LEL	N/A	N/A
	5.0 - 100 %vol CH <sub>4</sub>	0.5 %vol	N/A	N/A	N/A	N/A

### IR HC Target Gases

The infrared HC sensor is a general hydrocarbon sensor. It is setup for and factory-calibrated to isobutane.

The infrared HC sensor is known to **not** or to poorly respond to the following combustible gases:

- acetylene
- benzene
- hydrogen

### IR CH<sub>4</sub> Target Gases

The infrared methane sensor is setup for and factory-calibrated to methane. There are other gases that the sensor will still detect and respond to. There are also gases that the methane sensor will not detect or respond to. Lists of the gases falling in each of these respective categories can be found below. Consult RKI Instruments, Inc. for combustible gases not listed below.

The infrared methane sensor is known to respond to the following combustible gases:

- acetone
- ethane
- ethanol

- hexane
- IPA
- isobutane
- MEK
- methanol
- propane
- styrene
- toluene

The infrared methane sensor is known to **not** or to poorly respond to the following combustible gases:

- acetylene
- benzene
- hydrogen

---

## Description

### IR Sensor

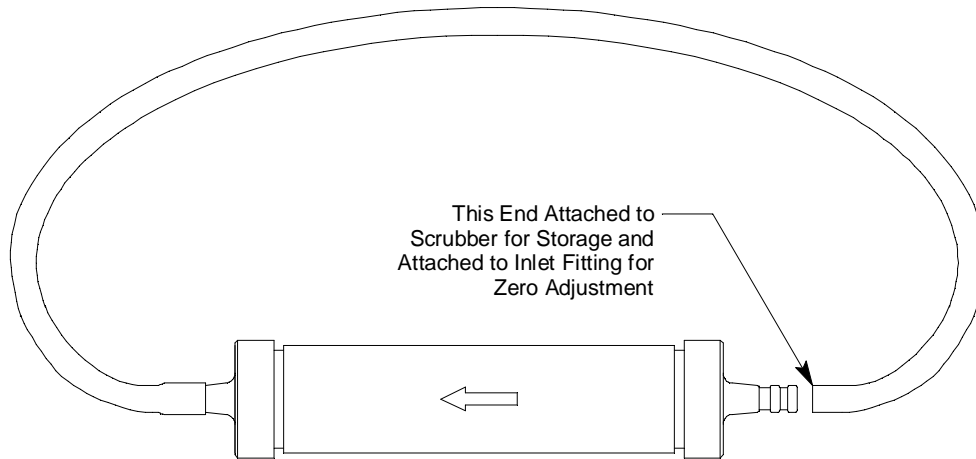
The IR sensor is a smart sensor that stores sensor parameters including the target gas, detection range, alarm points, and calibration settings in its memory. So a sensor can be calibrated at the factory and shipped as a replacement sensor without the need to calibrate the sensor when it is installed as long as it is installed during the sensor's valid calibration period which is typically 6 months. In addition, you can change an existing IR channel from one type of IR sensor to another and the GX-6000 will automatically load all the sensor parameters and configure the IR channel for the new sensor. See "Replacing an IR Sensor" on page 185 for instructions to replace or change an IR sensor.

The IR sensor is a cylindrical sensor with a diffusion opening on the front and a connector on the back. The IR sensor is installed in one of the two smart sensor sockets and is held in place by the sensor gasket and the flow chamber.

## CO<sub>2</sub> Scrubber

A carbon dioxide scrubber is factory-shipped with GX-6000s that have an IR CO<sub>2</sub> sensor installed.

The scrubber is for use when setting the carbon dioxide sensor's zero reading only. A single piece of tubing connects both ends of the scrubber when not in use. To prolong the life of the scrubber, be sure the tubing is connected to both ends of the scrubber while the scrubber is not in use or while it is being stored. Replace the scrubber when you notice the pellets in the scrubber tube beginning to break down into powder.

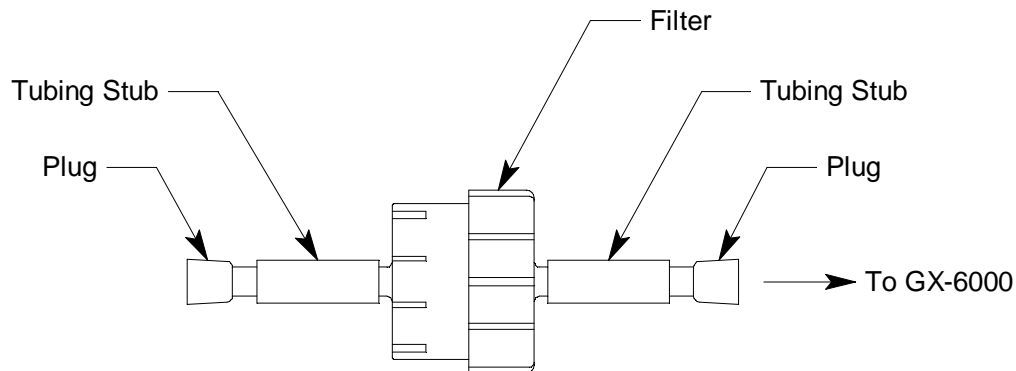


**Figure 40: Carbon Dioxide Scrubber**

## VOC Zero Filter

If your instrument has an IR CO<sub>2</sub> sensor and a PID sensor installed, a VOC zero filter is included as standard. The VOC zero filter scrubs out low levels of VOC gases using charcoal. Use the VOC zero filter when performing a fresh air adjustment on the instrument.

The filter comes with a tubing stub and plug on each end. Both plugs must be removed before using the filter and must be reinstalled for storage. The filter does not have a preferred flow direction.



**Figure 41: VOC Zero Filter**

---

## IR HC Start Up and Normal Operation

For instructions to startup and use a GX-6000 that includes an infrared hydrocarbon sensor, reference “Start Up” on page 25, “Measuring Mode, Normal Operation” on page 35, and “Measuring Mode, Alarms” on page 41.

### **0-100 %LEL/2.0-30.0 %vol Autoranging**

The infrared hydrocarbon sensor can be factory set to detect gas in a 0-100 %LEL configuration or an autoranging configuration. The autoranging configuration detects gas on a 0-100 %LEL and a 2.0-30.0 %vol scale. The gas reading will be displayed in %LEL until the gas level reaches 100 %LEL, or 2.0 %vol for isobutane. Once the gas reading is above 100 %LEL, it is displayed in %vol. Alarm points exist for the %LEL range but do not exist for the %vol range. If %LEL range alarms are not silenced (see pg.150 for a description of the alarm silence feature) and the gas level increases to %vol levels, the alarms will continue to sound but no new alarms will occur.

- If a CO sensor is installed and its charcoal filter becomes saturated, the presence of hydrocarbons may produce a reading on the CO channel.
- If a PID sensor is installed in your instrument, the presence of hydrocarbons that the IR HC sensor is intended to detect may produce upscale readings on the PID channel.

---

## IR CH<sub>4</sub> Start Up and Normal Operation

For instructions to startup and use a GX-6000 that includes an infrared methane sensor, reference “Start Up” on page 25, “Measuring Mode, Normal Operation” on page 35, and “Measuring Mode, Alarms” on page 41.

### **0 - 100 %LEL/5.0 - 100.0 %vol Autoranging**

The infrared methane sensor can be factory set to detect gas in a 0-100 %LEL configuration or an autoranging configuration. The autoranging configuration detects gas on a 0-100 %LEL and a 5.0-100.0 %vol scale. The gas reading will be displayed in %LEL until the gas level reaches 100 %LEL, or 5.0 %vol for methane. Once the gas reading is above 100 %LEL, it is displayed in %vol. Alarm points exist for the %LEL range but do not exist for the %vol range. If %LEL range alarms are not silenced (see pg.150 for a description of the alarm silence feature) and the gas level increases to %vol levels, the alarms will continue to sound but no new alarms will occur.

- If a PID sensor is installed in your instrument and concentrations of methane greater than 100 %LEL are present in the monitoring environment, the PID channel’s reading will be suppressed.

## IR CO<sub>2</sub> Start Up and Normal Operation

For instructions to startup and use a GX-6000 that includes an infrared CO<sub>2</sub> sensor, reference “Start Up” on page 25, “Measuring Mode, Normal Operation” on page 35, and “Measuring Mode, Alarms” on page 41. Follow these instructions keeping the following special considerations in mind:

- A background level of CO<sub>2</sub> exists in fresh air. Table 25 below indicates a typical gas reading in fresh air.

**Table 25: Carbon Dioxide Fresh Air Readings**

Sensor Range	Approximate Fresh Air Reading
0 - 10 %vol	0.04 %vol
0 - 10,000 ppm	400 ppm

- When you perform a demand zero during start up, operation, or calibration, you must use the CO<sub>2</sub> scrubber provided with the instrument to remove background CO<sub>2</sub> from the air being sampled. See “Performing a Demand Zero for Carbon Dioxide Sensors” below.

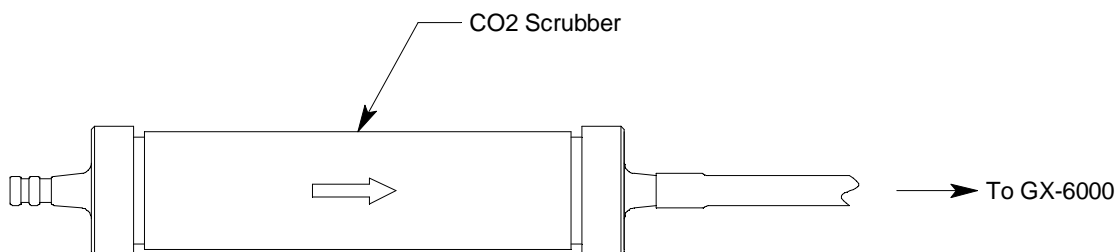
If you have a PID sensor in your instrument, see “Performing a Demand Zero for Instruments with a Carbon Dioxide Sensor and a PID Sensor” on page 184.

- Since there is a background of CO<sub>2</sub> in air, do not use the **AUTO ZERO** feature that can be turned on and off in Maintenance Mode. The factory setting for the feature is **OFF**.

### Performing a Demand Zero for Carbon Dioxide Sensors

When setting the zero reading, the carbon dioxide scrubber shipped with the GX-6000 allows you to eliminate carbon dioxide normally found in fresh air. To perform a demand zero, do the following:

1. Remove the tubing from the side of the scrubber that does not have an arrow pointing to it.
2. Connect the tubing to the GX-6000’s inlet fitting. Be sure the arrow on the filter is pointing toward the inlet fitting.



**Figure 42: CO<sub>2</sub> Scrubber Connected to GX-6000**

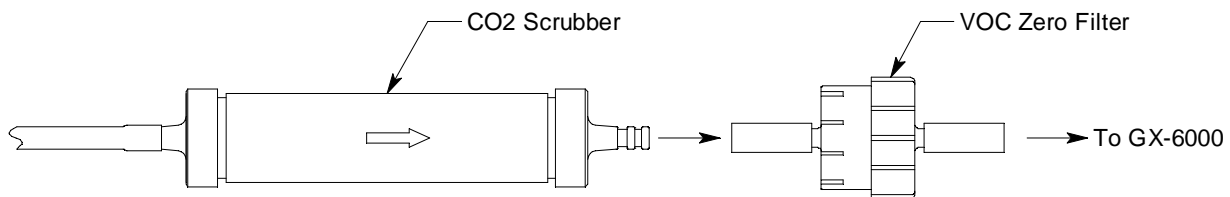
3. Wait one minute for the fresh air sample to flow through the carbon dioxide scrubber, then press and hold the ▲AIR button to set the zero reading.

4. Remove the scrubber from the inlet fitting.
5. Reattach the tubing to the open end of the scrubber.

### Performing a Demand Zero for Instruments with a Carbon Dioxide Sensor and a PID Sensor

If your instrument has both an IR CO<sub>2</sub> sensor and a PID sensor, you will need to use both the carbon dioxide scrubber and the VOC zero filter to perform a demand zero.

1. Remove the CO<sub>2</sub> scrubber's tubing from the side that has an arrow pointing to it.
2. Remove both plugs from the tubing stubs on the VOC zero filter.
3. Connect the VOC zero filter to the GX-6000's inlet fitting. The filter does not have a preferred flow direction.
4. Connect the CO<sub>2</sub> scrubber to the tubing stub on the other side of the VOC zero filter. Be sure the arrow on the CO<sub>2</sub> scrubber is pointing toward the VOC zero filter. See the figure below for the scrubber setup.



**Figure 43: CO<sub>2</sub> Scrubber and VOC Zero Filter Combination**

5. Wait one minute for the fresh air sample to flow through the scrubber setup.
6. Press and hold the ▲AIR button to set the zero reading.
7. Remove the CO<sub>2</sub> scrubber from the VOC zero filter. Be sure the VOC zero filter's tubing stays on the VOC zero filter.
8. Reattach the CO<sub>2</sub> scrubber's tubing to the open end of the scrubber.
9. Remove the VOC zero filter from the GX-6000's inlet fitting.
10. Reinstall the plugs on each end of the VOC zero filter.

---

**NOTE:** Do not store the CO<sub>2</sub> scrubber and VOC zero filter connected together. They must be separated and appropriately plugged for storage.

---



---

## IR Calibration

1. See “Calibrating Using the Auto Calibration Method” on page 72 or “Calibrating Using the Single Calibration Method” on page 83 for instructions to perform a calibration.

---

**NOTE:** If you are using the IR HC or IR CH<sub>4</sub> sensors in their autoranging configuration, be sure to calibrate the range you’d like the most accuracy in (either %LEL or %vol).

---

---

**NOTE:** If there is a PID sensor installed in your instrument and you are calibrating an IR CH<sub>4</sub> sensor with %vol concentrations, either calibrate the PID sensor first or allow enough time for the %vol CH<sub>4</sub> gas to flush out before calibrating the PID sensor.

---

---

## IR Bump Testing

1. See “Performing a Bump Test” on page 88 for instructions to perform a bump test.
- 

## Replacing an IR Sensor

When replacing a sensor, you may either replace it with another of the same sensor or you may install a different IR sensor. If a different one is installed, the GX-6000 will load the sensor parameters and configure the IR channel for the new sensor.

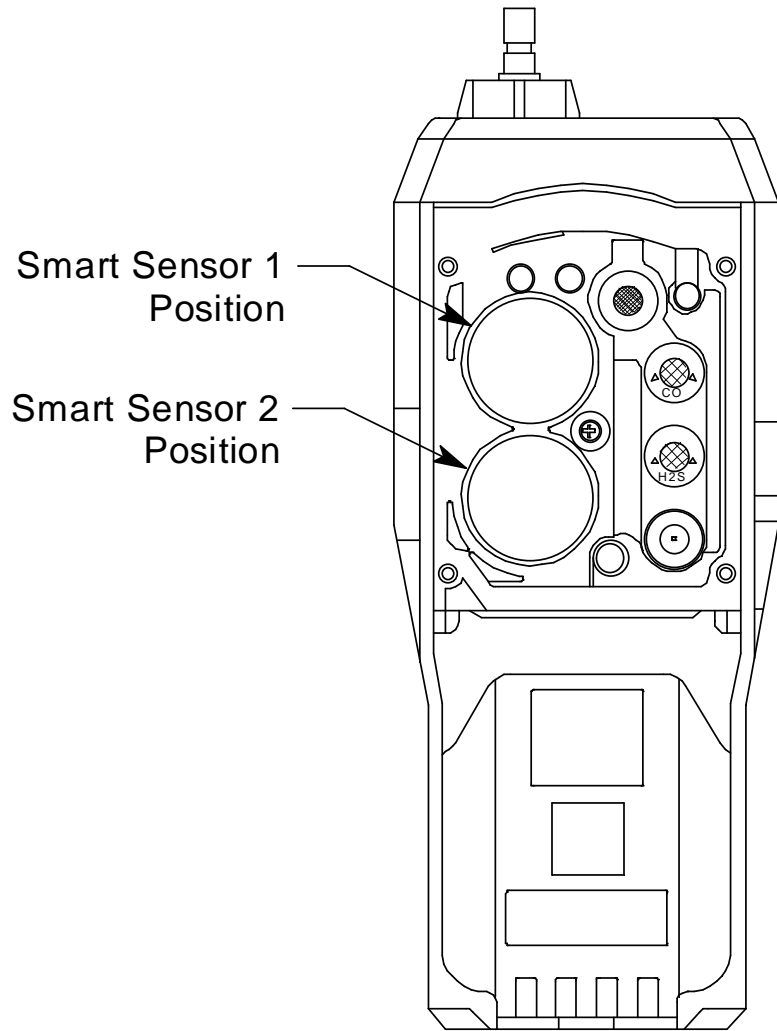
1. Follow the instructions listed in “Replacing a Sensor” on page 116.

Be sure that the new sensor is installed in the same position as the old sensor and that the following sensor priority for the smart sensor 1 position is maintained.

**Table 26: Priority for Smart Sensor 1 Position**

High Priority ↓ Low Priority	10.6 eV low range PID
	10.0 eV/benzene PID
	11.7 eV PID
	10.6 eV high range PID
	ESS-03 Chlorine
	ESS-03 Ammonia
	IR and other ESS-03 sensors

For example, if your instrument is a 4-gas + high range PID + IR HC, the high range PID sensor should be in the smart sensor 1 position and the IR HC sensor should be in the smart sensor 2 position. If your instrument is a 4-gas + IR HC, the IR HC sensor should be in the smart sensor 1 position and a dummy sensor should be installed in the smart sensor 2 position. See the figure below for the location of the smart sensor 1 and 2 positions.



**Figure 44: Smart Sensor Positions**

## Parts List

**Table 27: Infrared Sensors Parts List**

Part Number	Description
33-6015RK	CO <sub>2</sub> scrubber
33-6092	VOC zero filter, charcoal, with tubing stubs and plugs (for instruments that include an IR CO <sub>2</sub> sensor <u>and</u> a PID sensor)
81-0012RK-01	Calibration cylinder, 50 %LEL CH <sub>4</sub> in air, 34 liter steel
81-0012RK-03	Calibration cylinder, 50 %LEL CH <sub>4</sub> in air, 103 liter steel
81-0013RK-01	Calibration cylinder, 50 %vol CH <sub>4</sub> in nitrogen, 34 liter steel
81-0013RK-05	Calibration cylinder, 50 %vol CH <sub>4</sub> in nitrogen, 58 liter steel
81-0018RK-01	Calibration cylinder, 50 %LEL isobutane in air, 34 liter steel
81-0018RK-03	Calibration cylinder, 50 %LEL isobutane in air, 103 liter steel
81-0019RK	Calibration cylinder, 10 %vol isobutane in nitrogen, 17 liter steel
81-0071RK-01	Calibration cylinder, 5,000 ppm CO <sub>2</sub> in nitrogen, 34 liter
81-0071RK-03	Calibration cylinder, 5,000 ppm CO <sub>2</sub> in nitrogen, 103 liter
81-0072RK-01	Calibration cylinder, 2.5 %vol CO <sub>2</sub> in nitrogen, 34 liter
81-0072RK-03	Calibration cylinder, 2.5 %vol CO <sub>2</sub> in nitrogen, 103 liter
DES-3311-1	Infrared CO <sub>2</sub> sensor, 0 - 10 %vol
DES-3311-2	Infrared HC sensor, 0 - 100 %LEL/2.0 - 30.0 %vol autoranging
DES-3311-3	Infrared CH <sub>4</sub> sensor, 0 - 100 %LEL/5.0 - 100 %vol autoranging
DES-3311-4	Infrared CO <sub>2</sub> sensor, 0 - 10,000 ppm

# Appendix E: Using the GX-6000 in Leak Check Mode

---

## Overview

This chapter explains how to operate the GX-6000 in Leak Check Mode. Leak Check Mode is used to pinpoint small leaks of combustible gas from valves, flanges, connections, and other potential leak points. When the GX-6000 is in Leak Check Mode, only the catalytic combustible sensor and potentially the CO sensor, depending on the setting of the **CO DISPLAY** parameter in Maintenance Mode, will be active.

---

**NOTE:** If the **CO DISPLAY** parameter in Maintenance Mode is set to **ON**, the CO channel will appear in Leak Check Mode. If the **CO DISPLAY** parameter is set to **OFF** (factory setting), the CO channel will not appear in Leak Check Mode. All screens in this section do not show the CO channel. If your instrument's **CO DISPLAY** is set to **ON**, your screens may appear different.

---

If a GX-6000 is intended for tracking down leaks, it is shipped with Leak Check Mode or both Leak Check Mode and Bar Hole Mode enabled so that the operator must choose which operational mode to use when the unit is turned on (see “Updating the Leak Check/Bar Hole Mode Setting” on page 154).

---

## Start Up, Leak Check Mode

This section explains how to start up the GX-6000 in Leak Check Mode and get it ready for operation.

### Turning On the GX-6000, Leak Check Mode

**CAUTION:** *If one or more sensors other than a catalytic combustible sensor is installed, these sensors will not be active while the GX-6000 is in Leak Check Mode.*

---

**NOTE:** In order for **LEAK CHECK MODE** to appear as a selection in the Mode Select Screen, the **L./B. MODE** item in Maintenance Mode must be set to **LEAK CHECK MODE** or **LEAK CHECK MODE BAR HOLE MODE**. The factory setting is **OFF**.

---

1. Connect the tapered rubber nozzle or the sample hose and probe to the GX-6000's quick connect inlet fitting.

2. Press and briefly hold down the POWER/ENTER button. Release the button when you hear a beep. The Normal Mode Select Screen displays.

MODE SELECT		
NORMAL MODE		
CH4	100	%LEL
O2	40.0	%
H2S	100.0	ppm
CO	500	ppm
VOC	6000	ppm

3. Use the ▲AIR or SHIFT ▼ (PANIC) button to scroll to the Leak Check Mode Select Screen.

MODE SELECT		
LEAK CHECK MODE		

4. With the Leak Check Mode Select Screen displayed, press and release the POWER/ENTER button to begin the Leak Check Mode startup sequence.

---

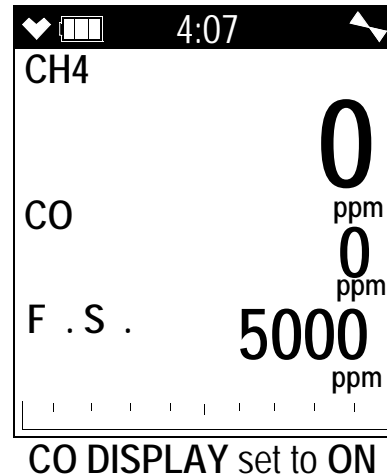
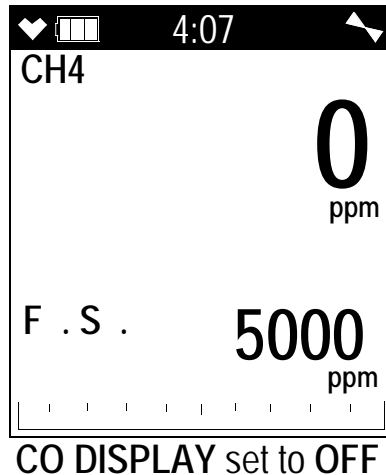
**NOTE:** If no button is pressed for 20 seconds, the unit will proceed into whichever mode is displayed.

---

5. See “Turning On the GX-6000” on page 25 for a description of the remainder of the warm-up sequence keeping the following in mind:
  - a. Even if **LUNCH BREAK** is set to **ON**, the Lunch Break Screen will not appear.
  - b. The Low Alarm, High Alarm, STEL, and TWA screens will not appear.
  - c. If the catalytic combustible sensor fails, it is not possible to enter Leak Check Mode. Press and release the RESET button to acknowledge the failure and return to the Normal Mode Select Screen. Replace the failed sensor.

If any other sensor that is installed fails, press and release the RESET button to acknowledge the failure and continue to Leak Check Mode. Change the failed sensor(s) as soon as possible for use in Normal Mode.

6. The GX-6000 is now monitoring for gas in Leak Check Mode. The pump is on and one of the following screens appears depending on the setting of the **CO DISPLAY** parameter in Maintenance Mode.



---

**NOTE:** For maximum sensor stability, allow 3-5 minutes for the sensor to warm up. The small increment size in the lower range of a ppm measurement can cause instability if the unit is not properly warmed up.

---

7. If you wish to change operating modes by returning to the Mode Select Screen, press and hold the **▲AIR** and **DISP/LOCK** buttons for 5 seconds.

### Performing a Demand Zero, Leak Check Mode

Before using the GX-6000, it is recommended to set the fresh air reading for the target gas by performing a demand zero. This will set the CH<sub>4</sub> channel to zero.

1. Find a fresh-air environment. This is an environment free of toxic or combustible gases and of normal oxygen content (20.9%).
2. Turn on the unit as described above in “Turning On the GX-6000, Leak Check Mode”.
3. Press and hold the **▲AIR** button. The display prompts you to hold the **▲AIR** button.
4. Continue to hold the **▲AIR** button until the display prompts you to release it. The GX-6000 will set the fresh air reading for the CH<sub>4</sub> channel. Start up is complete and the unit is now ready for monitoring.

---

## Leak Testing

In Leak Check Mode, the GX-6000 only displays combustible gas readings. The increment of the reading is always 100 ppm but the display range can be adjusted by using the **DISP/LOCK** button. The display range choices are 500 ppm, 1000 ppm, 2000 ppm, and 5000 ppm. The readings are displayed in both numerical and bar graph form. As the gas concentration increases from 0 ppm, the alarm LEDs begin to blink in unison with the buzzer’s pulsing. The blinking/pulsing rate increases as the gas reading increases.

In a low-light environment, press and release any of the buttons to turn on the display backlight. If **CONFIRMATION** is set to **ON** in the Maintenance Mode menu, the GX-6000 beeps once every user-defined interval to confirm that it’s operating.

## Setting the Display Range Value

The GX-6000's Leak Check Mode has 4 display range ppm values to choose from: 500 ppm, 1000 ppm, 2000 ppm, and 5000 ppm.

---

**NOTE:** The GX-6000 is always detecting combustible gas up to 5000 ppm. The display range value is only adjusting what part of the detection range is displayed on the LCD.

---

To change the display range value:

1. While in Leak Check Mode, press and release the DISP/LOCK button. The display range value displayed along the bottom of the screen will change.
2. Continue to press and release the DISP/LOCK button until the desired display range value is displayed.
3. The unit is now operating with the selected display range.

## Turning the Alarm On and Off

The alarm buzzer can be turned off and on in Leak Check Mode. This setting only applies to Leak Check Mode and does not affect buzzer operation in Normal Mode. When the buzzer is turned off, **NO ALARM** appears at the top of the screen. If the buzzer is turned off, then it will remain off in Leak Check Mode even if you enter Normal Mode and return to Leak Check Mode or turn the unit off and on unless the buzzer is manually turned on.

To turn the buzzer off or on while in Leak Check Mode:

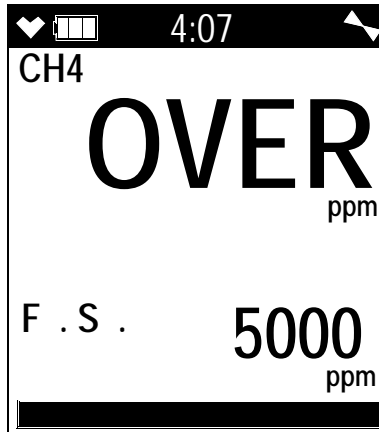
1. Press and hold the SHIFT ▼ (PANIC) and RESET buttons for 5 seconds.
2. Release the buttons when **NO ALARM** appears at the top of the screen.

## Locating a Leak

1. Start up the GX-6000 as described above in "Turning On the GX-6000, Leak Check Mode" on page 188.
2. Move the probe tip or tapered nozzle tip back and forth along the area where a leak is suspected.
3. Observe the display reading. If the gas level increases, the numerical reading will increase, the bar graph level will increase, and the beeping and buzzer pulsing frequency will increase.
4. Your gas reading may exceed your display range or 100% LEL. For a description of both scenarios, see the following section.
5. Use the increasing and decreasing of the reading to locate the leak point.
6. To exit Leak Check Mode and enter another mode, press and hold the ▲AIR and DISP/LOCK buttons for 5 seconds to access the Mode Select Screen.

## Overscale Conditions

If the gas level goes over the display range, the gas reading will be replaced with “OVER” and the LEDs and buzzer will pulse continuously until the overscale condition has cleared. Once the gas level gets low enough, the instrument will start showing ppm readings again.

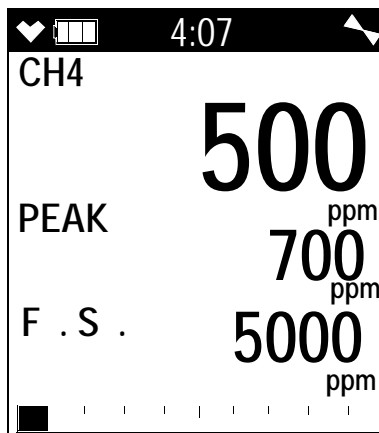


## Peak Hold Mode

Peak Hold Mode allows the user to view the peak methane reading for the operating session while viewing the current methane reading.

To enter Peak Hold Mode:

1. Turn the GX-6000 on as described in “Turning On the GX-6000, Leak Check Mode” on page 188. Select the desired display range. In the example below, 5000 ppm has been selected.
2. Press and release the RESET button. The Peak Hold Mode screen displays. The current methane reading is displayed on the first line. The peak methane reading is displayed on the second line. The display range is displayed on the third line.



3. If the highest reading recorded is higher than the display range value, “OVER” will be displayed instead of a gas reading. If the display range value is changed to something higher, the real value for the peak will be displayed.
4. To exit Peak Hold Mode and return to Leak Check Mode, press and release the RESET button.

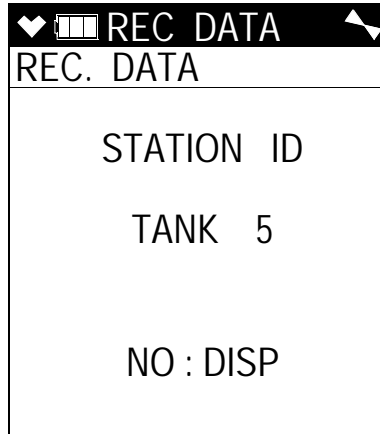


## Snap Log Mode, Leak Check Mode Operation

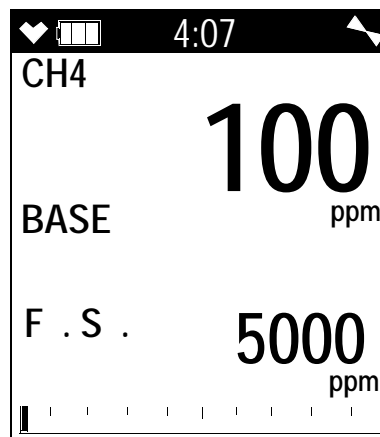
The snap logging function in Snap Log Mode allows the user to record data at a specific time and have it saved to the data logger. The data is assigned a snap log ID and is saved with the station ID that was selected when the data was taken.

To enter Snap Log Mode and record snap log data:

1. Turn the GX-6000 on as described in “Turning On the GX-6000, Leak Check Mode” on page 188.
2. Select the desired display range. In the example below, 5000 ppm has been selected.
3. Press and hold the SHIFT ▼ (PANIC) button, then press and hold the ▲AIR button and hold both until you hear a beep. The Station ID Select Screen will display and the current station ID will be in the middle of the screen.



4. To exit Snap Log Mode and return to Leak Check Mode, press and release the DISP/LOCK button.
5. Use the ▲AIR and SHIFT ▼ (PANIC) buttons to scroll to the desired station ID.
6. Press and release the POWER/ENTER button to continue to the Base Reading Screen.



---

**NOTE:** If **CO DISPLAY** is set to **ON**, the CO reading is saved during a snap log but will not be displayed in the Base Reading Screen, Peak Reading Screen, or while viewing snap log data at the instrument. However, the saved CO reading(s) can be viewed using the GX-6000 Datalogging Program.

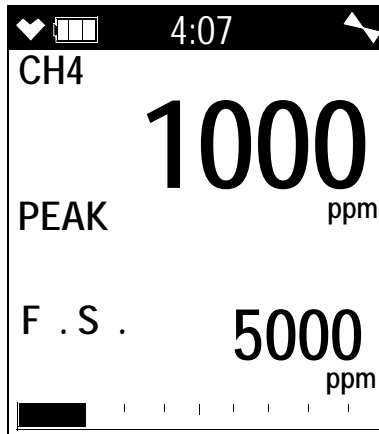
---

7. To return to the Station ID Select Screen without taking a base reading, press and release the RESET button. To exit Snap Log Mode completely and return to Leak Check Mode, press and release the DISP/LOCK button.
8. In order to get a base, or background, reading, take the instrument a few feet away from where you intend to test. To save the base reading, press and release the POWER/ENTER button.

**NOTE:** If the gas concentration exceeds the display range value without exceeding 5000 ppm, “OVER” will be displayed but the actual gas reading at that time will be recorded when you press and release POWER/ENTER. For example, if the display range is 500 ppm but the gas level is 2300 ppm, the display will read “OVER” but the instrument will save a reading of 2300 ppm.

If the gas concentration exceeds 5000 ppm in the Base Reading Screen, the instrument will go into an overscale alarm. The full scale display range value will be displayed but OVER will be recorded when you press POWER/ENTER. The full scale display range value will continue to be displayed in the Peak Reading Screen and OVER will again be recorded when you press POWER/ENTER.

9. The unit will display SAVED before continuing to the Peak Reading Screen.



10. Take the instrument to the monitoring area. The instrument will retain and display the highest gas concentration encountered.

To return to the Station ID Select Screen without taking a peak reading, press and release the RESET button.

To save the peak reading, press and release the POWER/ENTER button. The reading on the screen (the highest concentration encountered) will be saved.

**NOTE:** If the gas concentration exceeds the display range without exceeding 5000 ppm, “OVER” will be displayed but the actual gas reading at that time will be recorded when you press and release POWER/ENTER. For example, if the display range is 500 ppm but the gas level is 2300 ppm, the display will read “OVER” but the instrument will save a reading of 2300 ppm.

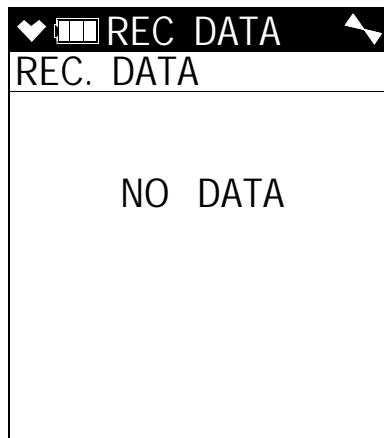
If the gas concentration exceeds 5000 ppm in the Peak Reading Screen, the instrument will go into an overscale alarm. The full scale display range value will be displayed and OVER will be recorded when you press POWER/ENTER.

- 11 . The unit will display SAVED before returning to the Station ID Select Screen.
12. Repeat Step 5 through Step 11 to take additional snap log data.
13. To exit Snap Log Mode at any time without taking a snap log or when you are finished recording snap logs, press and release the DISP/LOCK button. The unit will immediately return to the Leak Check Mode Screen.
14. The data recorded in Snap Log Mode can be viewed in Display Mode. See the next section for more information.

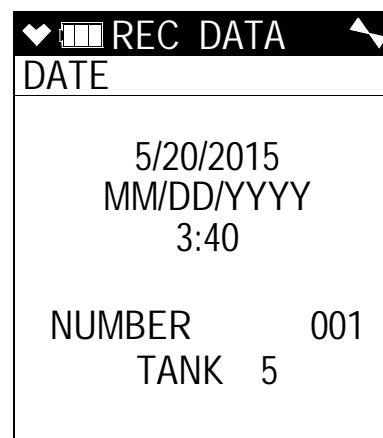
## Viewing Snap Log Data in Leak Check Mode Operation

Snap log data can be viewed while in Leak Check Mode. If snap log data was taken while in Measuring Mode, that data will also appear.

1. Turn the GX-6000 on as described in “Turning On the GX-6000, Leak Check Mode” on page 188.
2. Press and hold the RESET button and then press and hold the DISP/LOCK button and release both. The screen that appears will depend on whether or not any snap logs have been taken.



No snap logs taken



Snap logs taken

- 3 . If snap logs have been taken, the screen indicates the year, month, day, and time that the most recent snap log was taken.  
 The number near the bottom of the screen indicates the snap log ID number. The first snap log that is taken is given an ID of 001. The next snap log ID is 002. The ID number increases sequentially with each set of snap log data.  
 The last line of the screen indicates the Station ID that was used for the snap log.
- 4 . Press and release the DISP/LOCK button to return to Leak Check Mode.
- 5 . Use the ▲AIR and SHIFT ▼(PANIC) buttons to scroll through different snap log IDs and view what time they were taken. Snap log data that was taken in Leak Check Mode operation will have two snap log ID numbers. One number is for the gas reading and the other is for the peak reading.
6. To view the data in a snap log ID, press and release the POWER/ENTER button. The gas readings that were taken during the snap log are displayed.

### ID Screen

### Data Screen

REC DATA

DATE

5/20/2015  
MM/DD/YYYY  
3:47

NUMBER 003  
TANK 5

4:07

CH4

1000 ppm

PEAK

F . S . 5000 ppm

Leak Check  
Mode Peak  
Data

SHIFT ▼ ▲ AIR

SHIFT ▼ ▲ AIR

REC DATA

DATE

5/20/2015  
MM/DD/YYYY  
3:45

NUMBER 002  
TANK 5

4:07

CH4

100 ppm

BASE

F . S . 5000 ppm

Leak Check  
Mode Base  
Data

SHIFT ▼ ▲ AIR

SHIFT ▼ ▲ AIR

REC DATA

DATE

5/20/2015  
MM/DD/YYYY  
3:40

NUMBER 001  
TANK 5

REC DATA

CH4	02
0 %LEL	20.9 %
H2S	CO
0.0 ppm	0 ppm
VOC	
0 ppm	

Normal  
Mode  
Data

Snap log data that was taken in Leak Check Mode operation will have 2 sequential screens that are part of one data set. One screen is for the base reading and the other screen is for the peak reading. "BASE" and "PEAK" will appear in the gas reading screen for each type of reading, respectively. If a base data point appears without a peak data point after it, it is because a peak data point was not taken.

---

**NOTE:** Even if **CO DISPLAY** was set to **ON** when the Leak Check snap logs were taken, the CO reading will not be displayed. The CO readings can be viewed using the GX-6000 Datalogging Program.

---

7. Use the ▲AIR and SHIFT ▼(PANIC) buttons to scroll through the different snap log data screens. The gas readings will change but the snap log ID is not visible from this screen.
8. You can also go back and forth between the ID and data screens by pressing and releasing the POWER/ENTER button.
9. To return to Leak Check Mode, press and release the DISP/LOCK button.

### **Turning Off the GX-6000, Leak Check Mode**

1. Press and hold the POWER/ENTER button.
2. TURN OFF will appear on the display and the buzzer will pulse for about five seconds.
3. Release the button when TURN OFF disappears from the display.

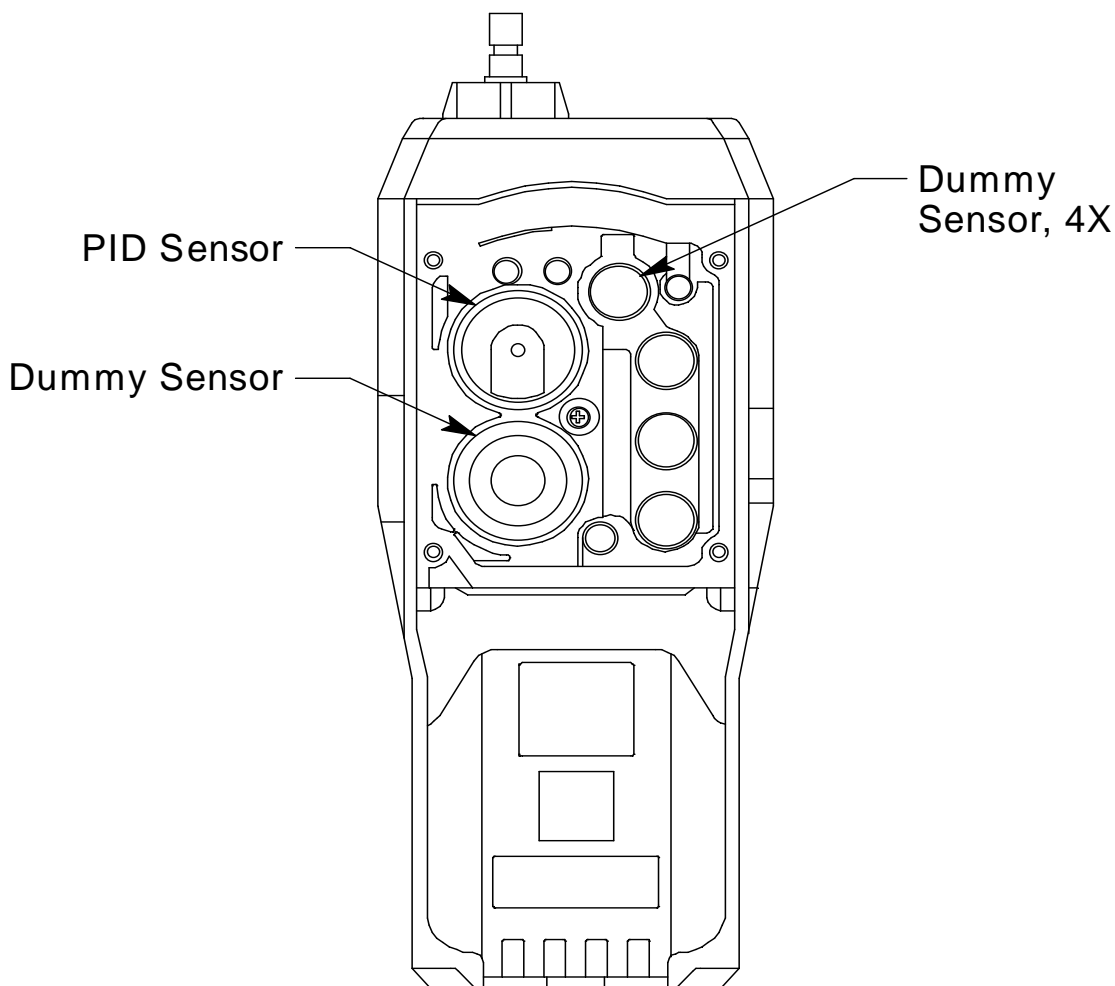
# Appendix F: Using the GX-6000 in Bar Hole Mode

## Overview

This chapter explains how to operate the GX-6000 in Bar Hole Mode. Bar Hole Mode is used to perform consistent checks of bar holes when tracking down underground gas leaks. When the GX-6000 is in Bar Hole Mode, only the IR combustible and oxygen (if installed and active) channels are displayed.

If a GX-6000 is intended for bar hole testing, it is shipped with Bar Hole Mode enabled so that the operator must choose which operational mode to use when the unit is turned on.

In order to use a GX-6000 in Bar Hole Mode, an IR CH<sub>4</sub> or an IR HC sensor must be installed in the Smart Sensor 1 Position in the instrument. Bar Hole Mode will display an oxygen reading if an oxygen sensor is installed and active but an oxygen sensor is not required for Bar Hole Mode use.



**Figure 45: Sensor Location Diagram**

---

## Start Up, Bar Hole Mode

This section explains how to start up the GX-6000 in Bar Hole Mode and get it ready for operation.

### Turning On the GX-6000, Bar Hole Mode

**WARNING:** *Gas alarms are not active when the GX-6000 is in Bar Hole Mode.*

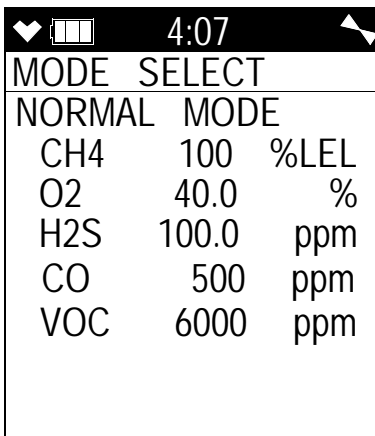
**CAUTION:** *If any sensors other than an IR CH<sub>4</sub>/IR HC or oxygen sensor is installed, these sensors will not be active while the GX-6000 is in Bar Hole Mode.*

---

**NOTE:** In order for **BAR HOLE MODE** to appear as a selection in the Mode Select Screen, the **L./B. MODE** item in Maintenance Mode must be set to **BAR HOLE MODE** or **LEAK CHECK MODE BAR HOLE MODE**. The factory setting is **OFF**.

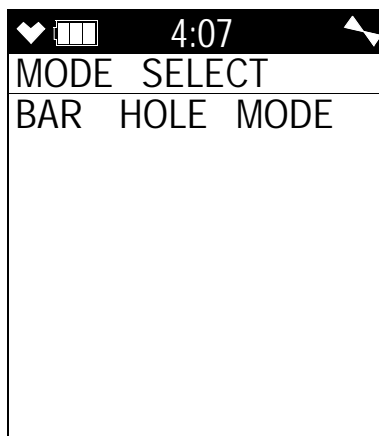
---

1. Connect the tapered rubber nozzle or the sample hose and probe to the GX-6000's quick connect inlet fitting.
2. Press and briefly hold down the POWER/ENTER button. Release the button when you hear a beep. The Normal Mode Select Screen displays.



MODE SELECT		
NORMAL MODE		
CH4	100	%LEL
O2	40.0	%
H2S	100.0	ppm
CO	500	ppm
VOC	6000	ppm

3. Use the ▲AIR or SHIFT ▼ (PANIC) button to scroll to the Bar Hole Mode Select Screen.



MODE SELECT		
BAR HOLE MODE		

4. With the Bar Hole Mode Select Screen displayed, press and release the POWER/ENTER button to begin the Bar Hole Mode startup sequence.

---

**NOTE:** If no button is pressed for 20 seconds, the unit will proceed into whichever mode is displayed.

---

5. See “Turning On the GX-6000” on page 25 for a description of the remainder of the warm-up sequence keeping the following in mind:
  - a. Even if **LUNCH BREAK** is set to **ON**, the Lunch Break Screen will not appear.
  - b. The Low Alarm, High Alarm, STEL, and TWA screens will not appear.
  - c. If the IR CH<sub>4</sub> or IR HC (whichever is installed) sensor fails, it is not possible to enter Bar Hole Mode. Press and release the RESET button to acknowledge the failure and return to the Normal Mode Select Screen. Replace the failed sensor.  
  
If oxygen sensor fails, press RESET to acknowledge the failure and then continue to Bar Hole Mode. No oxygen reading will be displayed. Replace the failed sensor as soon as possible.  
  
If any other installed sensor fails, press and release the RESET button to acknowledge the failure and continue to Bar Hole Mode. Change the failed sensor(s) as soon as possible for use in Normal Mode.
6. The GX-6000 is now operating in Bar Hole Mode. The pump is off and the following screen appears.



The combustible gas and oxygen channels are displayed along with the battery charge level and station ID.

---

**NOTE:** If the oxygen sensor fails or if the oxygen channel is turned off, no oxygen indication will display on the Bar Hole Mode screen.

---

### Performing a Fresh Air Adjustment, Bar Hole Mode

Before using the GX-6000, it is recommended to set the fresh air readings for the target gases by performing a fresh air adjustment. This will set the combustible gas channel to zero and the OXY channel to 20.9%.

1. Find a fresh-air environment. This is an environment free of toxic or combustible gases and of normal oxygen content (20.9%).
2. Turn on the unit as described above in “Turning On the GX-6000, Bar Hole Mode”.



3. Press and hold the ▲AIR button. The pump will start and the display will prompt you to hold the ▲AIR button.
4. Continue to hold the ▲AIR button until the display prompts you to release the ▲AIR button. The GX-6000 will set the fresh air reading for the combustible gas and oxygen channels as it counts down from 8. Once the countdown has finished, start up is complete and the unit is ready for bar hole testing.

---

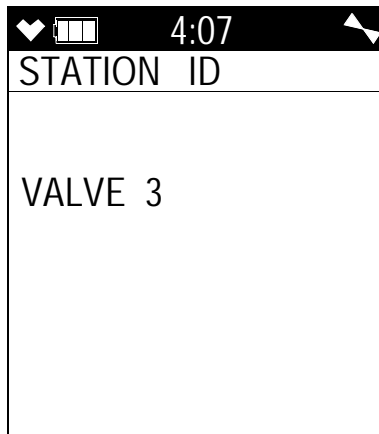
## Bar Hole Testing

In Bar Hole Mode, you can initiate sampling for a fixed time period to monitor for combustible gas and oxygen in a bar hole. The factory set time is 30 seconds. To change the bar hole sampling time, see “Setting the Bar Hole Measurement Time” on page 155. At the end of the sample period, the pump will shut off and the peak combustible gas and minimum oxygen levels monitored during the sample period will be displayed. Bar Hole Mode also allows you to initiate an air purge cycle to purge gas from the GX-6000 after a sample is taken.

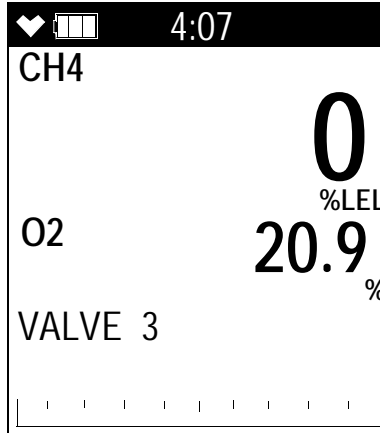
In a low-light environment, press and release the SHIFT ▼ (PANIC) button to turn on the display backlight. Although the backlight will turn on when any button is pressed, other buttons may initiate an undesired operation sequence. See “Updating the Backlight Time Setting” on page 151 to program backlight duration. If **CONFIRMATION** is turned on in the Maintenance Mode menu, the GX-6000 beeps once every user-defined interval to confirm that it’s operating.

### Performing a Bar Hole Test

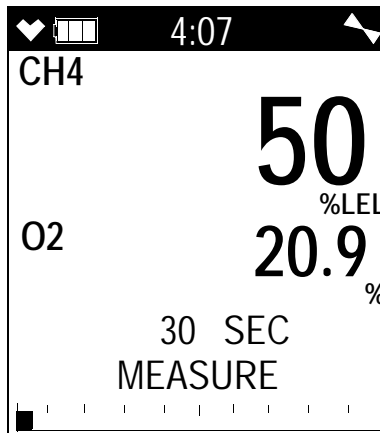
1. Start up the GX-6000 as described in “Start Up, Bar Hole Mode” on page 199.
2. If you wish to change the station ID, press the SHIFT ▼ (PANIC) and DISP/LOCK buttons and release when you hear a beep. The current station ID will be displayed and it will be flashing. If you wish to exit the Station ID Select Screen without making any changes, press and release the RESET button.



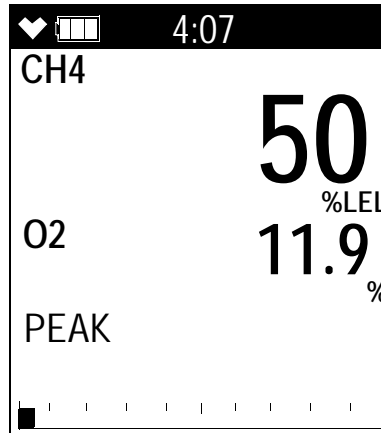
3. Use the ▲AIR and SHIFT ▼(PANIC) buttons to scroll to the desired station ID and press and release POWER/ENTER. The unit will return to the Bar Hole Measuring Screen.



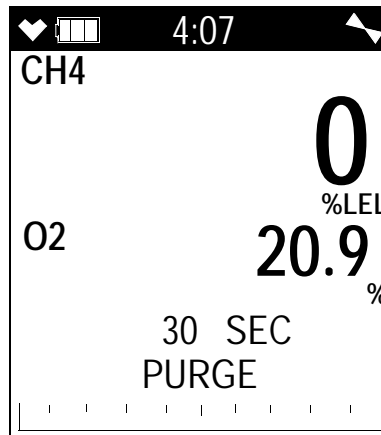
4. Take the GX-6000 to the bar hole that will be tested.
5. Insert the probe into the bar hole and press and release the POWER/ENTER button. The pump will turn on and the sample period will begin with the sample period counting down in seconds in the lower middle portion of the display. “MEASURE” will flash below the countdown. The combustible gas channel will automatically switch between %LEL or %vol based on the level of gas present. The combustible gas channel’s reading will also be displayed in graph format on the bottom of the screen. If you wish to cancel the measurement, press and release the RESET button.



- 6 . At the end of the sample period, the pump will shut off and the buzzer will sound, then the peak combustible gas reading and the minimum oxygen reading for the sample period will be displayed. The peak combustible gas reading will also be visually displayed on the graph along the bottom of the screen.



- 7 . If a high concentration of combustible gas is encountered, a fresh air purge can be performed to purge the hose, probe and GX-6000 of gas before the next bar hole test. To perform a purge, do the following:
- Remove the probe from the barhole so the instrument will draw fresh air.
  - Press and release the DISP/LOCK button. The display will now indicate PURGE along the bottom of the screen and the purge time will begin counting down from 30 seconds in the lower middle portion of the display. If you wish to cancel the purge, press and release the RESET button.



- When the purge is complete, the screen will return to the initial Bar Hole Mode screen.



- 8 . If other bar holes will be tested, proceed to the next bar hole and repeat steps Step 5 - Step 7.
- 9 . To cancel a bar hole measurement or fresh air purge that is in progress, press and release the RESET button.
- 10 . To exit Leak Check Mode and enter another mode, press and hold the ▲AIR and DISP/LOCK buttons for 5 seconds to access the Mode Select Screen.

### **Turning Off the GX-6000, Bar Hole Mode**

- 1 . Press and hold the POWER/ENTER button.
- 2 . The unit will initiate a bar hole measurement. Keep holding the POWER/ENTER button. The buzzer will pulse for about three seconds and TURN OFF will appear at the bottom of the screen.
- 3 . Release the button when TURN OFF disappears.

## Appendix G: Using the GX-6000 in Inert Mode

Inert Mode is used to measure the combustible gas and/or oxygen level in a purged environment. In order for the instrument to operate in Inert Mode, the oxygen alarm must be set to H-HH operation meaning that both alarms are increasing. The oxygen Low Alarm High Alarm points are factory set at 5.0% and 10.0%.

It is recommended that an IR CH<sub>4</sub> or IR HC sensor be installed if the instrument is going to be used in Inert Mode since these sensors do not require oxygen to work properly. The catalytic LEL sensor does not operate at oxygen concentrations below 10 %volume. If it is necessary to use the catalytic LEL sensor while operating in Inert Mode, a dilution fitting must be installed. Installing a dilution fitting will affect the oxygen reading since you're introducing oxygen into the sample.

---

**NOTE:** **INERT MODE** must be set to **ON** in Maintenance Mode for Inert Mode to be an option in the Mode Select Screen at startup.

---

### Alarms

The oxygen channel alarm points in Inert Mode are different from those in Normal Mode. All other alarm points settings remain unchanged.

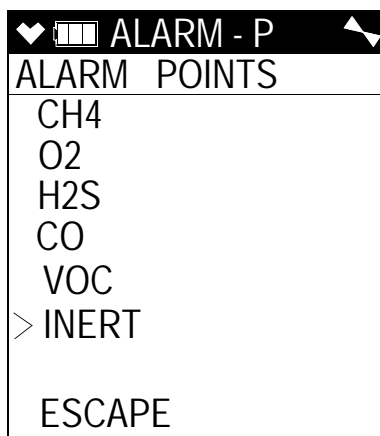
Since the application for Inert Mode is to detect a rising oxygen level in purged environments, both oxygen alarms are rising in Inert Mode. The factory set alarm points for Inert Mode are 5.0 %volume (Low Alarm) and 10.0 %volume (High Alarm). These Inert Mode alarm points are user adjustable in Maintenance Mode.

1. Follow the steps described in “Updating the Alarm Point Settings” on page 149 to change the alarm points for Inert Mode. The only difference between what’s described in that section and what the screen will look like is that **INERT** will be an option in the Alarm Points Menu if **INERT MODE** is set to **ON** in Maintenance Mode.

---

**NOTE:** If **INERT MODE** is set to **OFF** in Maintenance Mode, the **INERT** item will not appear in the Alarm Points Menu.

---

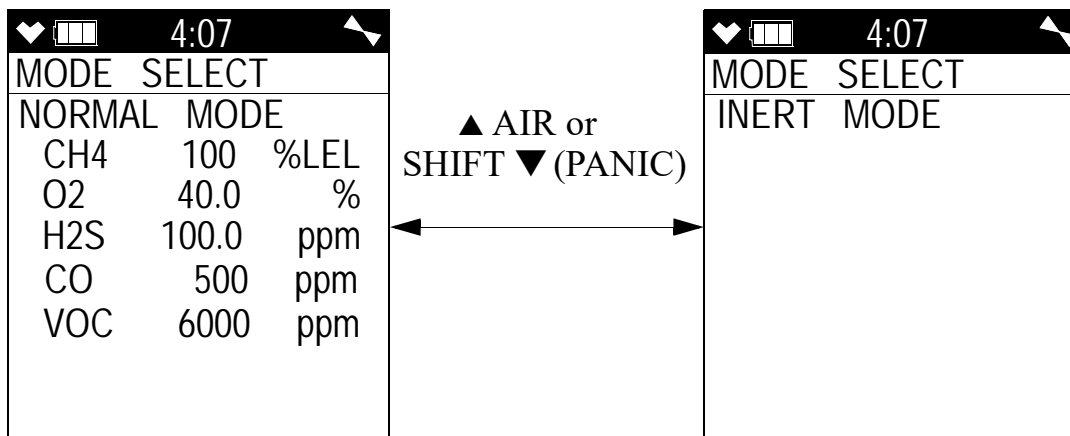


2. Select **INERT** (not **O2**) in order to view or change Inert Mode’s oxygen alarm points.

## Start Up and Operation

1. Connect the tapered rubber nozzle or the sample hose and probe to the GX-6000's quick connect inlet fitting.
2. Press and briefly hold down the POWER/ENTER button. Release the button when you hear a beep.
3. The Normal Mode Select Screen displays. Use the ▲AIR or SHIFT ▼(PANIC) button to scroll to the Inert Mode Select Screen.

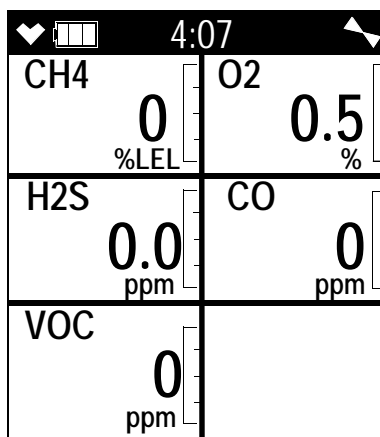
**NOTE:** **INERT MODE** must be set to **ON** in Maintenance Mode for Inert Mode to be an option in the Mode Select Screen at startup.



4. With the Inert Mode Select Screen displayed, press and release the POWER/ENTER button to begin the Inert Mode startup sequence.

**NOTE:** If no button is pressed for 20 seconds, the unit will proceed into whichever mode is displayed.

5. The warm-up will proceed as described in “Turning On the GX-6000” on page 25.
6. Once the warm-up sequence has finished, the instrument will be operating in Inert Mode. Since the oxygen concentration in fresh air is above both Inert Mode oxygen alarm points, the GX-6000 will go into alarm if turned on in a fresh air environment.



7. If you wish to change operating modes by returning to the Mode Select Screen, press and hold the ▲AIR and DISP/LOCK buttons for 5 seconds.

# Appendix H: 10.0 eV/Benzene PID Sensor

## Overview

This appendix describes the GX-6000's 10.0 eV/benzene sensor (RKI part number PID-003L).

The 10.0 eV/benzene PID sensor detects VOCs in the 0-100.00 ppm range when used in Measuring Mode. It is optimized for benzene detection. The standard calibration for the 10.0 eV/benzene PID sensor is to benzene but it can be factory setup for and calibrated to other gases. Regardless of the calibration gas, the 10.0 eV/benzene sensor will still detect and respond to a variety of volatile organic compounds (VOCs) while used in Measuring Mode. Even though the 10.0 eV/benzene sensor can be used for general VOC detection, if your application is for general VOC detection and is not related to monitoring for benzene specifically, RKI Instruments, Inc. recommends that the low range or high range 10.6 eV PID sensor be used instead.

The 10.0 eV/benzene PID sensor detects VOCs in the 0-50.00 ppm range when used in Benzene Select Mode. The filter tube that needs to be used in Benzene Select Mode allows benzene to pass through but scrubs out all other VOCs except for nitrobenzene, cyclohexane, n-octane, and n-pentane. Common applications for the 10.0 eV/benzene PID sensor include process monitoring where only benzene is present or petroleum industry monitoring where other VOCs may be present.

See the table below for 10.0 eV/benzene sensor specifications.

**Table 28: 10.0 eV/Benzene PID Sensor Specifications**

	<b>Measuring Mode Operation</b>	<b>Benzene Select Mode Operation</b>
<b>Detection Range</b>	0 - 100.00 ppm	0 - 50.00 ppm
<b>Reading Increment</b>	0 - 10 ppm: 0.01 ppm 10 - 100 ppm: 0.1 ppm	0 - 10 ppm: 0.01 ppm 10 - 50 ppm: 0.1 ppm
<b>Alarm 1 Factory Setting</b>	5 ppm	N/A
<b>Alarm 2 Factory Setting</b>	10 ppm	N/A
<b>STEL Alarm</b>	N/A	N/A
<b>TWA Alarm</b>	N/A	N/A

## Sensor Description

The PID sensor is a cylindrical sensor with a diffusion opening on the front and 3 pins on the back. It is installed in a white housing that has three sockets on the bottom that mate with the GX-6000 instrument. The PID sensor must always be installed in the first smart sensor position which is located in the top left corner of the sensor block.

## Tube and Tube Holder

Benzene detection typically requires the use of a filter tube. The filter tube will scrub out most VOCs other than benzene but will not scrub out nitrobenzene, cyclohexane, n-octane, or n-pentane. The filter tube is installed in a tube holder and needs to be replaced regularly.

A tube holder and a box of tubes are included with 10.0 eV/benzene versions of the GX-6000.

### Tube

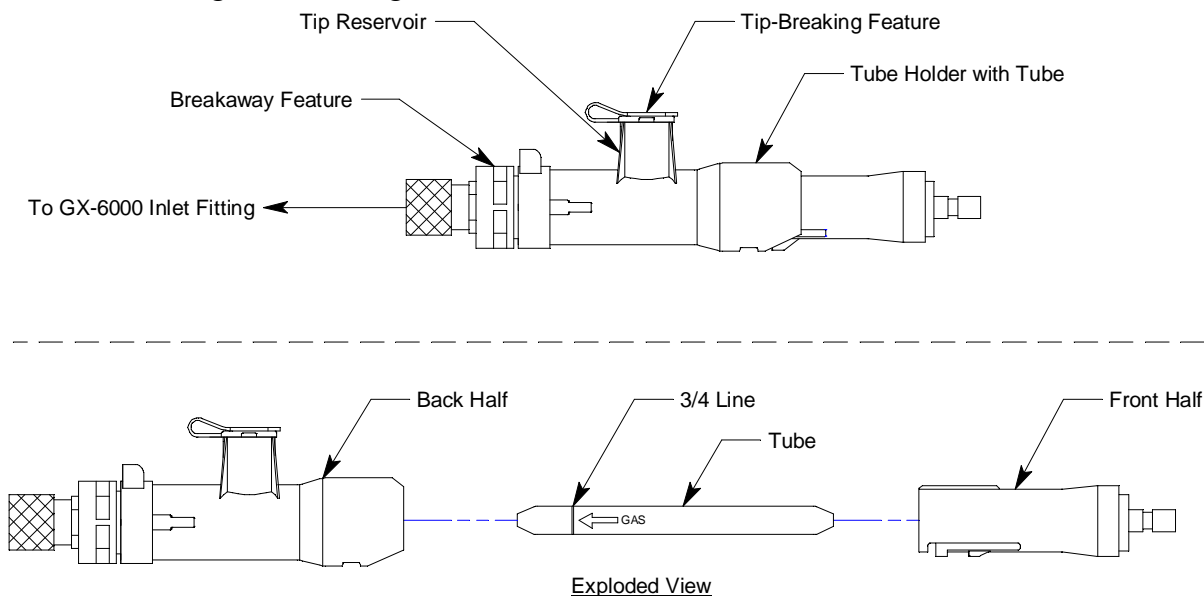
Each tube has a 3/4 line on it. If the tube becomes discolored and if the discoloration extends beyond the 3/4 line, the tube is no longer effectively scrubbing non-benzene gases and needs to be replaced.

Tubes must be stored in a cool, dark place (0 - 25 °C/ 32 - 77 °F) and must be used before the expiration date that is printed on the box. If the tubes are being stored in a refrigerator, take them out of the refrigerator and let them sit overnight before using them.

Tubes do not contain cadmium, mercury, or chrome and may be disposed as general waste.

### Tube Holder

The tube holder attaches to the GX-6000's inlet fitting. It has a breakaway feature ensuring that the GX-6000 will not be damaged by hitting the tube holder on something when it is installed. The tube holder should only be used in Benzene Select Mode or when performing a calibration in TUBE CAL. If the tube holder is attached to the instrument's inlet fitting in Measuring Mode, it will cause a low flow alarm.



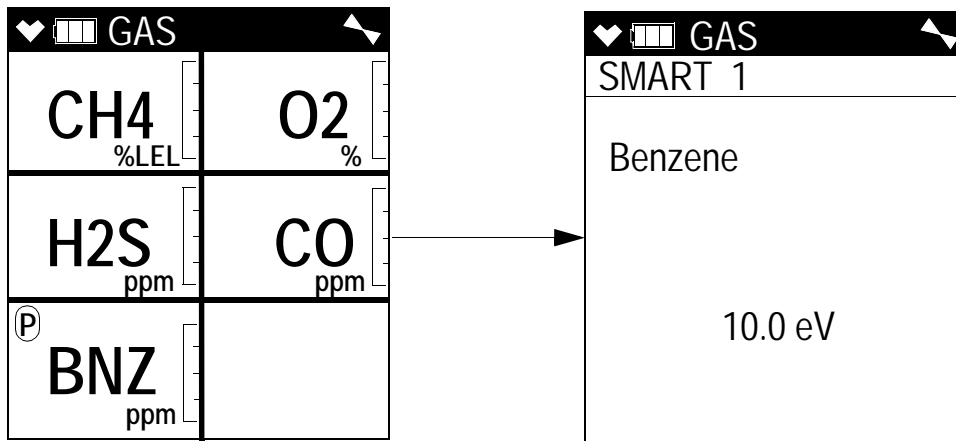
**Figure 46: Tube Holder Component Location**



---

## Start Up

The instructions for starting up a GX-6000 with a 10.0 eV/benzene PID sensor installed are the same as described in “Start Up” on page 25 with the exception of the screens shown in Step 8. Those screens appear as shown below.

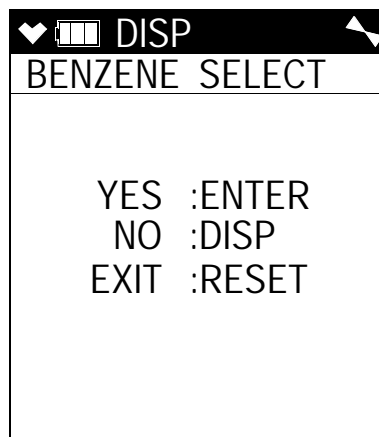


---

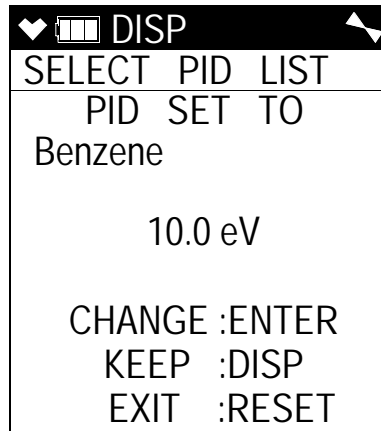
## Display Mode

Display Mode for a 10.0 eV/benzene PID instrument appears and functions as described in “Display Mode” on page 47 with the following exceptions:

- A Benzene Select Mode screen is now the first item in Display Mode. Benzene Select Mode is described in “Benzene Select Mode” on page 211.



- The PID Gas Name Screen operates as described in “PID Gas Name Screen” on page 49 but is factory set up for and calibrated to benzene and appears as shown below. If there are 2 PID sensors installed in your GX-6000, the PID Gas Name Screens will appear in Display Mode in the following order regardless of their position in the flow system: 10.0 eV/benzene, 10.6 eV, 11.7 eV.



## Measuring Mode

The 10.0 eV/benzene sensor detects VOCs in the 0-100.00 ppm range in Measuring Mode. See “Measuring Mode, Normal Operation” on page 35 for a complete description of Measuring Mode.

If the 10.0 eV/benzene PID sensor is one of two PID sensors installed in your instrument, as shipped from the factory, the 10.0 eV/benzene PID channel will say “BNZ” and the low or high range PID channel will say “VOC”.

If you change the target gas of the 10.0 eV/benzene PID sensor to something other than benzene in Display Mode, both channels will appear as “VOC”. In that case, the channel that appears first will be based on the following sensor priority.

High Priority ↓ Low Priority	10.6 eV low range PID
	10.0 eV/benzene PID
	11.7 eV PID
	10.6 eV high range PID

**NOTE:** If you have changed the factory-set channel assignments using the **CONFIGURE CH** menu item in User Mode, the order of displayed sensors may be different and you will need to remember how you set your instrument up.

---

## Benzene Select Mode

Benzene Select Mode allows the user to monitor for benzene in the 0-50.00 ppm range. Readings taken in Benzene Select Mode are saved to the instrument's memory. See "Viewing Benzene Select Mode Data" on page 217 for a description of viewing data.

---

**NOTE:** A PID-003L 10.0 eV/benzene sensor must be installed in order for the Benzene Select Mode screen to appear.

---

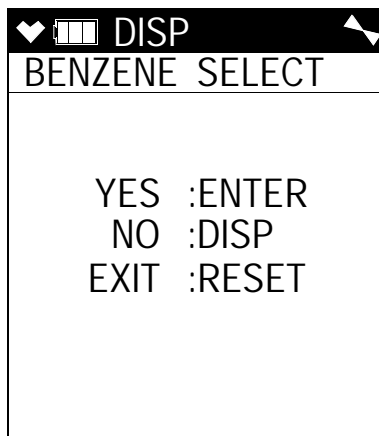
A tube holder and filter tube are necessary for monitoring an area in Benzene Select Mode.

Be sure to perform an appropriate calibration for Benzene Select Mode use as described in "Important Calibration Information" on page 219 before continuing.

**WARNING:** *If you take the GX-6000 to an area that is 10 or 15 degrees different than the previous area, allow the instrument 45 minutes to acclimate before taking any readings. Failure to do so may cause the reading to be inaccurate.*

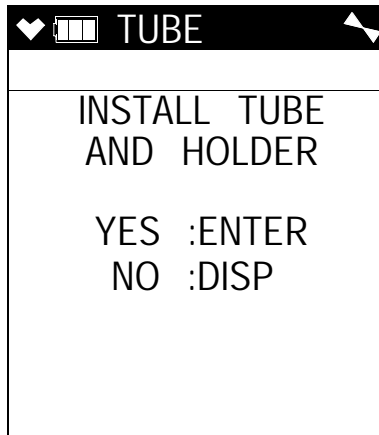
**WARNING:** *There are no alarm indications in Benzene Select Mode.*

- 1 . Enter Display Mode by pressing the DISP/LOCK button while in Measuring Mode. The Benzene Select Mode Screen appears.

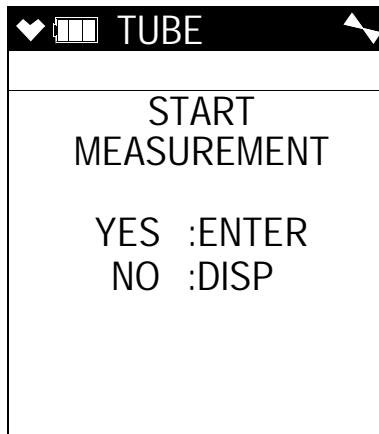


- 2 . Press and release the POWER/ENTER button to enter Benzene Select Mode.

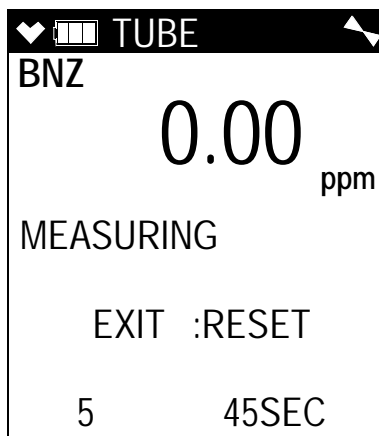
3. The pump will stop and the instrument will prompt you to install the filter tube and tube holder.



4. Be sure a filter tube is installed in the tube holder and then attach the tube holder to the instrument's inlet fitting. See "Replacing a Tube" on page 229 for instructions.
5. Press and release the POWER/ENTER button to confirm the tube and holder have been installed.
6. You will be prompted to start a benzene measurement.



7. Press and release the POWER/ENTER button to start the benzene measurement.
8. The benzene reading is displayed at the top of the screen. An automatically-determined, temperature-based countdown is displayed at the bottom of the screen. The number to the left of the countdown ("5" in the example below) is the temperature code.



- 9 . To cancel the measurement, press and release the RESET button.



- Press the POWER/ENTER button to confirm the measurement cancel.
  - Press the DISP/LOCK button to return to the measuring screen without canceling the measurement.
- 10 . Once the measurement is over, the final reading is displayed and you are asked if you want to repeat the measurement.

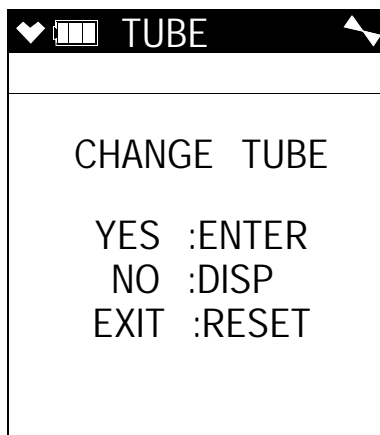


- To repeat a measurement, continue to Step 11.
- To not repeat a measurement and return to Measuring Mode, continue to Step 12.
- To start a STEL measurement, continue to Step 13.

11 . To start another measurement, press and release the POWER/ENTER button.

**WARNING:** *If you take the GX-6000 to an area that is 10 or 15 degrees different than the previous area, allow the instrument 45 minutes to acclimate before taking any readings. Failure to do so may cause the reading to be inaccurate.*

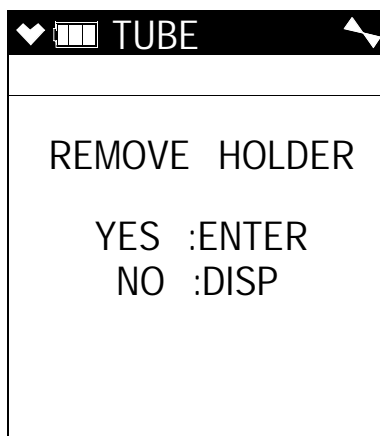
- a. You will be prompted to change the tube before continuing. See “Replacing a Tube” on page 229 for instructions.



- b. Once the tube is changed, press and release the POWER/ENTER button to start the measurement. Return to Step 8.

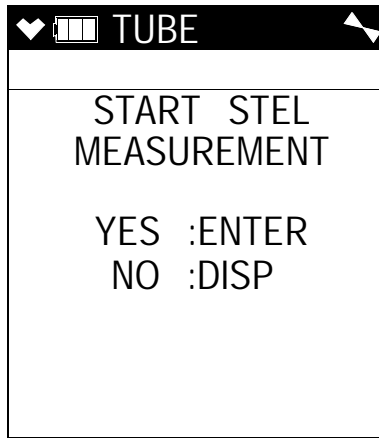
12 . To not start another measurement and to return to Measuring Mode, press and release the DISP/LOCK button.

- a. You will be prompted to remove the tube holder from the instrument’s inlet fitting.

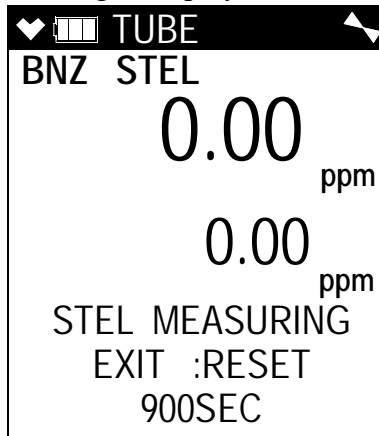


- b. Remove the tube holder from the GX-6000’s inlet fitting.  
c. Press and release the POWER/ENTER button.

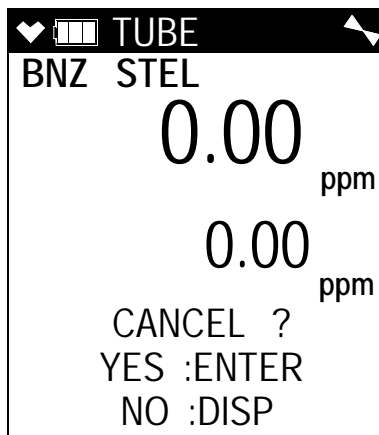
13 . To proceed with taking a STEL measurement, press and release the RESET button.



- a. Press and release the POWER/ENTER button to start a STEL measurement.
- b. The STEL measurement takes 15 minutes and a countdown displays at the bottom of the screen. The STEL reading is displayed at the top of the screen and the instantaneous reading is displayed below it.



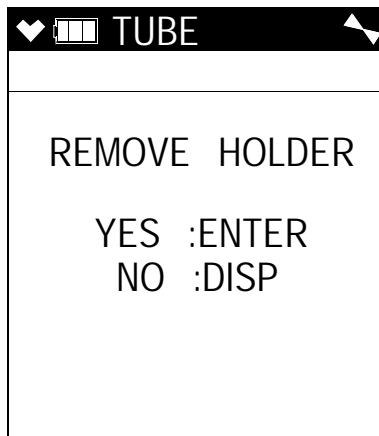
- c. To cancel the STEL measurement, press and release the RESET button. Then press and release the POWER/ENTER button.



- d. At the end of the STEL countdown, the STEL reading displays.



- e. To repeat the STEL measurement, press and release POWER/ENTER.
- f. To return to Measuring Mode, press and release the DISP/LOCK button. You will be prompted to remove the tube holder from the instrument's inlet fitting.



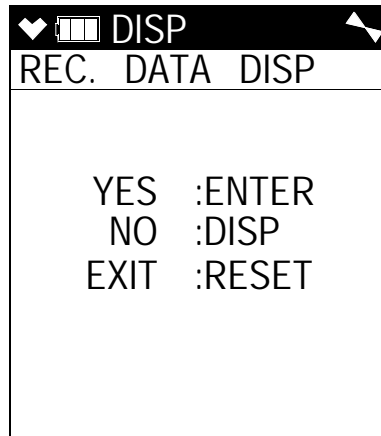
- g. Remove the tube holder from the GX-6000's inlet fitting.
- h. Press and release the POWER/ENTER button.



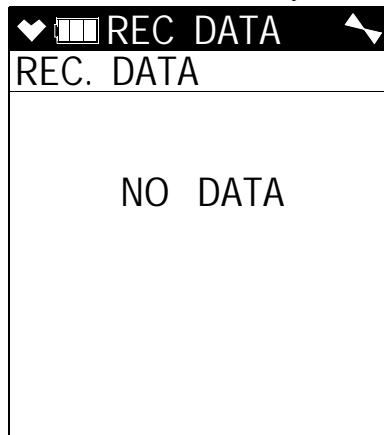
## Viewing Benzene Select Mode Data

Readings taken in Benzene Select Mode are saved to the snap logger. To view Benzene Select Mode readings, do the following:

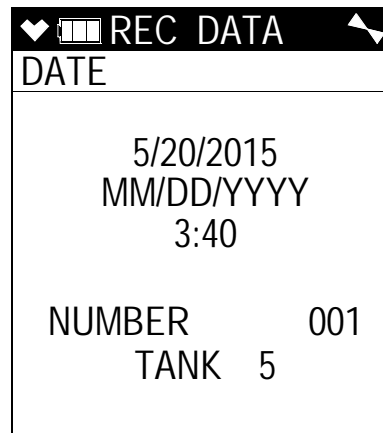
1. From Measuring Mode, press and release the DISP/LOCK button to enter Display Mode.
2. Continue pressing the DISP/LOCK button until the snap logging screen appears.



3. Press and release the POWER/ENTER button. The screen that appears will depend on whether or not any data has been saved to the snap logger.



No data saved



Data saved

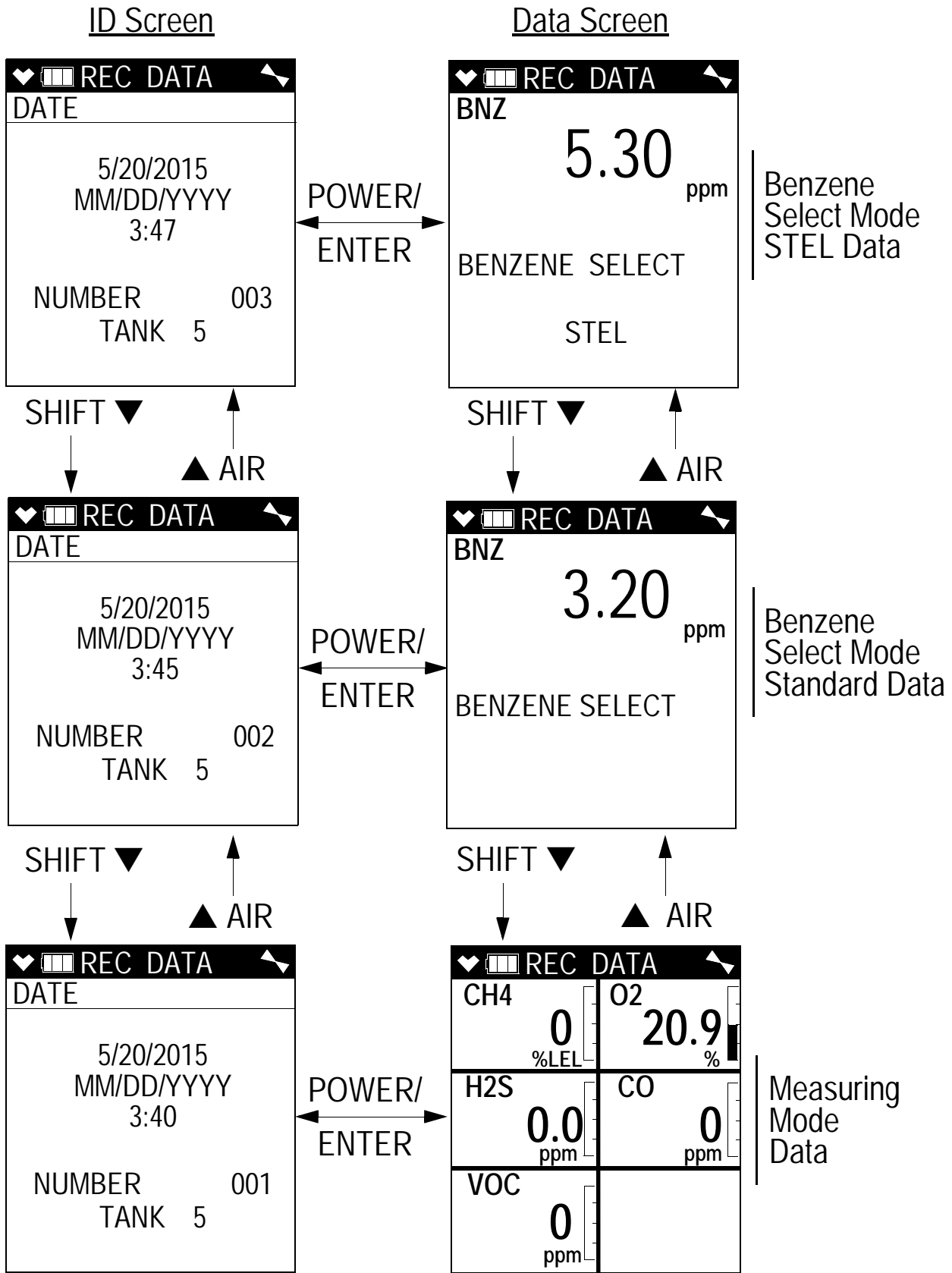
4. If snap logs have been taken, the screen indicates the year, month, day, and time that the most recent snap log was taken.

The number near the bottom of the screen indicates the snap log ID number. The first snap log that is taken is given an ID of 001. The next snap log ID is 002. The ID number increases sequentially with each set of snap log data.

The last line of the screen indicates the Station ID that was used for the snap log.

5. Use the ▲AIR and SHIFT ▼(PANIC) buttons to scroll through different snap log IDs.

6. To view the data in a snap log ID, press and release the POWER/ENTER button.



The instrument saves data from a Benzene Select Mode standard measurement and from a Benzene Select Mode STEL measurement (if performed). Data from a Benzene Select Mode standard measurement will say “BENZENE SELECT” below the reading. Data from a Benzene Select Mode STEL measurement will say “BENZENE SELECT” and “STEL” below the reading. They are separate files. Data may also be present from snap log data saved in Measuring Mode.

7. Use the ▲AIR and SHIFT ▼(PANIC) buttons to scroll through the different snap log data screens. The gas readings will change but the snap log ID is not visible from this screen.
8. You can also go back and forth between the ID and data screens by pressing and releasing the POWER/ENTER button.
9. To return to the Snap Logging Screen, press and release the DISP/LOCK button.
10. To return to Measuring Mode, press and release the RESET button.

---

## Calibrating the 10.0 eV/Benzene PID Sensor

### Important Calibration Information

Calibration of the 10.0 eV/benzene PID sensor depends on your application and on the calibration gas you have available. The most accurate way to calibrate the sensor is to use benzene gas. If it is not practical or possible to use benzene gas, another gas, such as isobutylene, can be used as long as the calibration code indicated on the box of filter tubes is entered into the instrument.

If you start using a new box of filter tubes, you may need to recalibrate. See Step 6 on page 231 for further description.

See the table below for a summary of the calibration options and requirements.

Application	Calibration Options	
Benzene Select Mode benzene detection	Option 1	1. AUTO CAL or SINGLE CAL with benzene, without tube and holder 2. TUBE CAL with benzene, with tube and holder
	Option 2	1. AUTO CAL or SINGLE CAL with isobutylene (or other target gas)** 2. enter CAL CODE
Measuring Mode, benzene detection	AUTO CAL with benzene (no TUBE CAL or CAL CODE required)	
Measuring Mode, general VOC detection*	Option 1	AUTO CAL or SINGLE CAL with benzene
	Option 2	AUTO CAL or SINGLE CAL with isobutylene (or other target gas)**
<p>* Even though it is possible to use the 10.0 eV/benzene PID sensor for general VOC detection, RKI Instruments, Inc. recommends using the low range or high range 10.6 eV sensor instead.</p> <p>** In order to calibrate to a gas other than benzene or isobutylene, you must select that other gas for the 10.0 eV/benzene sensor in the PID Gas Name Screen in Display Mode as described in “PID Gas Name Screen” on page 49. You must also select the appropriate calibration gas during the calibration procedure.</p>		

## Setting the Fresh Air Reading

See “Setting the Fresh Air Reading” on page 72 for instructions to set the fresh air reading.

## Performing an AUTO CAL

See “Calibrating Using the Auto Calibration Method” on page 72 for instructions to perform an automatic calibration while keeping the following in mind:

- Be sure that you are doing a complete calibration as appropriate for your application and for the calibration gas you have available (see “Important Calibration Information” on page 219).
- If the 10.0 eV/benzene PID sensor is one of two PID sensors installed in your instrument, as shipped from the factory, the 10.0 eV/benzene PID channel will say “BNZ” and the low or high range PID channel will say “VOC”.

If you change the target gas of the 10.0 eV/benzene PID sensor to something other than benzene in Display Mode, both channels will appear as “VOC”. In that case, the channel that appears first will be based on the following sensor priority. Be sure to select the correct PID sensor for calibration.

High Priority	10.6 eV low range PID
↓	10.0 eV/benzene PID
↓	11.7 eV PID
Low Priority	10.6 eV high range PID

---

**NOTE:** If you have changed the factory-set channel assignments using the **CONFIGURE CH** menu item in User Mode, the order of displayed sensors may be different and you will need to remember how you set your instrument up.

---

## Performing a SINGLE CAL

See “Calibrating Using the Single Calibration Method” on page 83 for instructions to perform a single calibration while keeping the following in mind:

- Be sure that you are doing a complete calibration as appropriate for your application and for the calibration gas you have available (see “Important Calibration Information” on page 219).
- If the 10.0 eV/benzene PID sensor is one of two PID sensors installed in your instrument, as shipped from the factory, the 10.0 eV/benzene PID channel will say “BNZ” and the low or high range PID channel will say “VOC”.

If you change the target gas of the 10.0 eV/benzene PID sensor to something other than benzene in Display Mode, both channels will appear as “VOC”. In that case, the channel that appears first will be based on the following sensor priority. Be sure to select the correct PID sensor for calibration.

High Priority	10.6 eV low range PID
↓	10.0 eV/benzene PID
↓	11.7 eV PID
Low Priority	10.6 eV high range PID

---

**NOTE:** If you have changed the factory-set channel assignments using the **CONFIGURE CH** menu item in User Mode, the order of displayed sensors may be different and you will need to remember how you set your instrument up.

---

## Performing a TUBE CAL

---

**NOTE:** A PID-003L 10.0 eV/benzene sensor must be installed in order for the TUBE CAL menu item to appear in Calibration Mode.

---

**NOTE:** If you begin to use filter tubes from a new box and if the calibration code shown on the new box is different than the calibration code shown on the old box, you must perform a TUBE CAL operation using one of the tubes from the new box.

---

**WARNING:** *If you take the GX-6000 to an area that is 10 or 15 degrees different than the previous area, allow the instrument 45 minutes to acclimate before taking any readings. Failure to do so may cause the calibration to be inaccurate.*

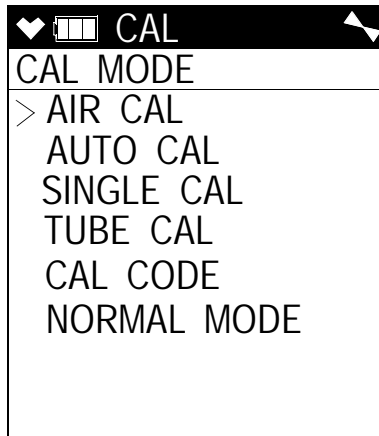
To calibrate the 10.0 eV/benzene sensor in TUBE CAL, you will need:

- A benzene calibration cylinder. RKI Instruments, Inc. recommends a concentration of 5 ppm.
- A demand-flow regulator to provide adequate sample gas flow.
- Non-absorbent tubing.
- Tube holder and filter tube.

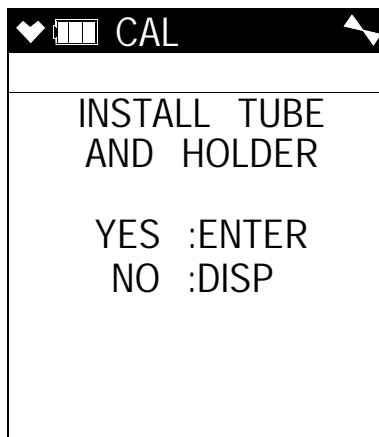
Be sure that you are doing a complete calibration as appropriate for your application and for the calibration gas you have available (see “Important Calibration Information” on page 219).

## Automatic TUBE CAL

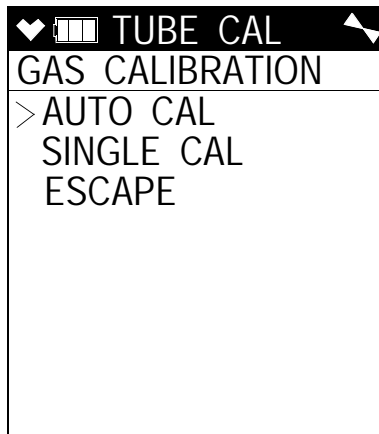
1. To enter Calibration Mode, while in Measuring Mode, press and hold the SHIFT ▼ (PANIC) button, then press the DISP/LOCK button and release both buttons.



2. Use the SHIFT ▼ (PANIC) button to scroll to **TUBE CAL** and then press and release the POWER/ENTER button.
3. The pump will stop and the instrument will prompt you to install the filter tube and tube holder.

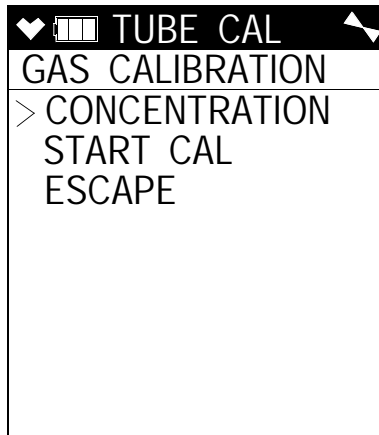


4. Be sure a filter tube is installed in the tube holder and then attach the tube holder to the instrument's inlet fitting. See "Replacing a Tube" on page 229 for instructions.
5. Press and release the POWER/ENTER button to enter the TUBE CAL Menu.

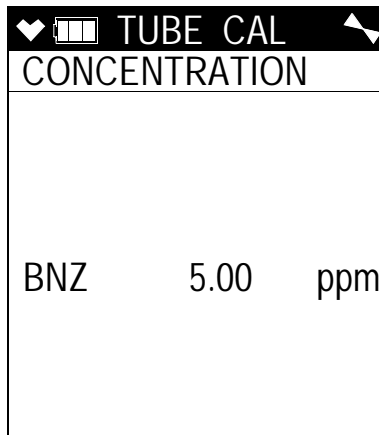


6. Use the SHIFT ▼ (PANIC) button to place the cursor next to **AUTO CAL**.

7. Press and release the POWER/ENTER button to enter the TUBE CAL Auto Calibration Menu.



8. To view or change the benzene concentration to be used for the TUBE CAL:
  - a. Use the SHIFT ▼ (PANIC) button to place the cursor next to **CONCENTRATION**.
  - b. Press and release the POWER/ENTER button. The current concentration will be shown and it will be flashing.

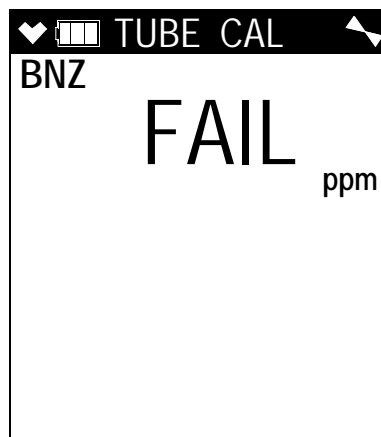


- c. Use ▲AIR or SHIFT ▼ (PANIC) to adjust the concentration.
    - d. Press and release the POWER/ENTER button to save it.
9. Screw the demand flow regulator onto the benzene calibration cylinder.
10. Attach the calibration tubing to the demand flow regulator.
11. Attach the other end of the calibration tubing to the tube holder's inlet fitting.
12. Use the SHIFT ▼ (PANIC) button to place the cursor next to **START CAL**.

- 13 . Press and release the POWER/ENTER button to start a calibration. An automatically-determined, temperature-based countdown is displayed at the bottom of the screen. The number to the left of the countdown (“5” in the example below) is the temperature code.



- 14 . If the calibration passes, the screen will indicate PASS and will return you to the TUBE CAL Auto Calibration Menu.
- 15 . If the calibration fails, a failure screen will appear and the instrument will go into alarm.

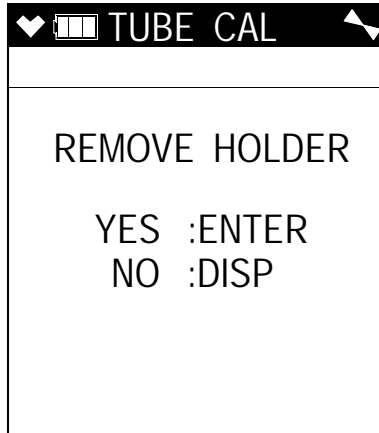


Press and release the RESET button to clear the alarm and return to the TUBE CAL Auto Calibration Menu. See “Troubleshooting” on page 100.

- 16 . Use the SHIFT ▼ (PANIC) button to place the cursor next to **ESCAPE**, then press and release the POWER/ENTER button to return to the TUBE CAL Menu.



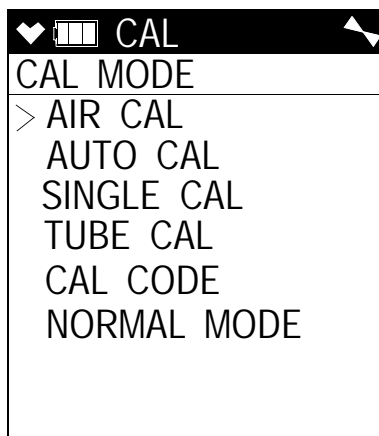
- 17 . Use the SHIFT ▼ (PANIC) button to place the cursor next to **ESCAPE**, then press and release the POWER/ENTER button. You will be prompted to remove the filter tube and tube holder.



- 18 . Remove the tube holder from the GX-6000's inlet fitting.
- 19 . Press and release the POWER/ENTER button. You will return to the Calibration Mode Menu.
- 20 . Use the SHIFT ▼ (PANIC) button to place the cursor next to the **NORMAL MODE** menu option, then press and release the POWER/ENTER button to return to Measuring Mode.
- 21 . Detach the calibration tubing from the tube holder's inlet fitting.
- 22 . Unscrew the demand flow regulator from the calibration cylinder.

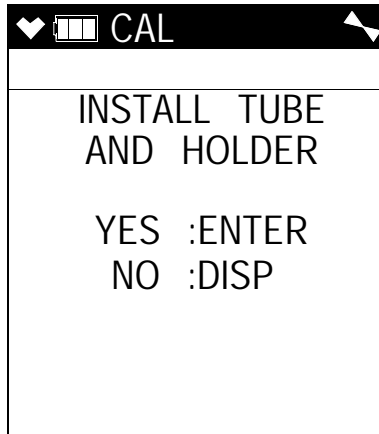
### **Single TUBE CAL**

- 1 . To enter Calibration Mode, while in Measuring Mode, press and hold the SHIFT ▼ (PANIC) button, then press the DISP/LOCK button and release both buttons.

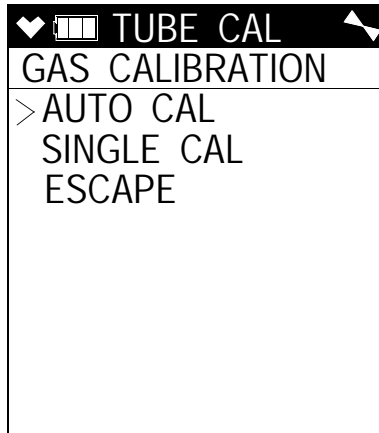


- 2 . Use the SHIFT ▼ (PANIC) button to place the cursor next to **TUBE CAL** and then press and release the POWER/ENTER button.

3. The pump will stop and the instrument will prompt you to install the filter tube and tube holder.

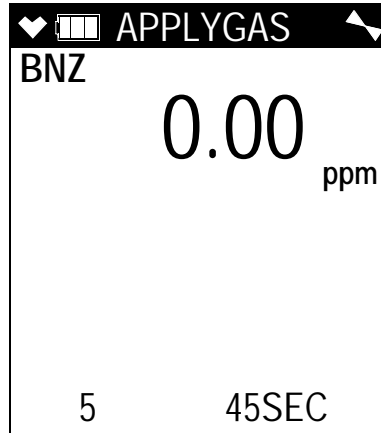


4. Be sure a filter tube is installed in the tube holder and then attach the tube holder to the instrument's inlet fitting. See "Replacing a Tube" on page 229 for instructions.
5. Press and release the POWER/ENTER button to enter the TUBE CAL Menu.

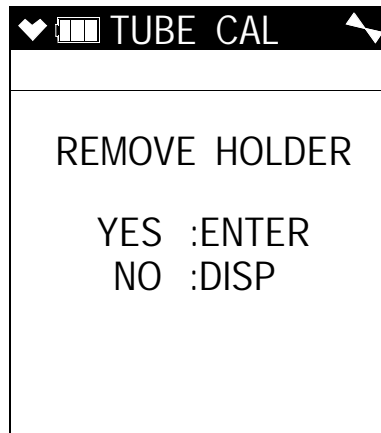


6. Screw the demand flow regulator onto the benzene calibration cylinder.
7. Attach the calibration tubing to the demand flow regulator.
8. Attach the other end of the calibration tubing to the tube holder's inlet fitting.
9. Use the SHIFT ▼ (PANIC) button to place the cursor next to **SINGLE CAL**.
10. Press and release the POWER/ENTER button.

- 11 . An automatically-determined, temperature-based countdown is displayed at the bottom of the screen. The number to the left of the countdown (“5” in the example below) is the temperature code.



- 12 . At the end of the countdown, use the ▲AIR or SHIFT ▼ (PANIC) button to adjust the reading to match the concentration listed on the calibration cylinder.
- 13 . Press and release the POWER/ENTER button.
- 14 . If the calibration passes, the screen will indicate PASS and will return you to the TUBE CAL Menu.  
If the reading cannot be adjusted to match the cylinder concentration, see “Troubleshooting” on page 100.
- 15 . Use the SHIFT ▼ (PANIC) button to place the cursor next to **ESCAPE**, then press and release the POWER/ENTER button. You will be prompted to remove the filter tube and tube holder.



- 16 . Remove the tube holder from the GX-6000’s inlet fitting.
- 17 . Press and release the POWER/ENTER button. You will return to the Calibration Mode Menu.
- 18 . Use the SHIFT ▼ (PANIC) button to place the cursor next to the **NORMAL MODE** menu option, then press and release the POWER/ENTER button to return to Measuring Mode.
- 19 . Detach the calibration tubing from the tube holder’s inlet fitting.
- 20 . Unscrew the demand flow regulator from the calibration cylinder.

## Entering a CAL CODE

---

**NOTE:** A PID-003L 10.0 eV/benzene sensor must be installed in order for the CAL CODE menu item to appear in Calibration Mode.

---

**NOTE:** If you begin to use filter tubes from a new box and if the calibration code shown on the new box is different than the calibration code shown on the old box, you must enter the new calibration code before using the new filter tubes.

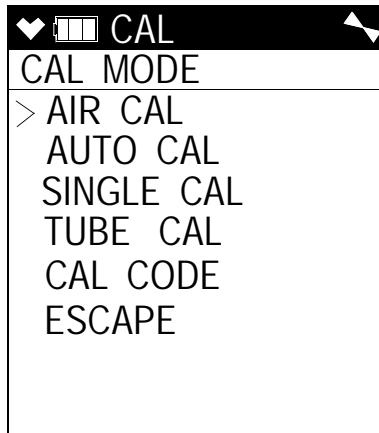
---

An alternative to performing a TUBE CAL using a benzene calibration cylinder is to enter the calibration code found on the filter tube box. The cal code adjusts the instrument's reading in Benzene Select Mode to account for the effect that the filter tube has on the PID sensor's response to benzene. It is listed on the tube box's label and is a letter between A and J.

If you go through the CAL CODE procedure, there is no need to perform a TUBE CAL using a benzene calibration cylinder.

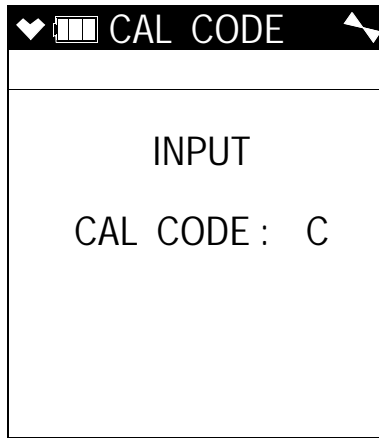
Be sure that you are doing a complete calibration as appropriate for your application and for the calibration gas you have available (see "Important Calibration Information" on page 219).

1. To enter Calibration Mode, press and hold the SHIFT ▼ (PANIC) button, then press the DISP/LOCK button and release both buttons.



2. Use the SHIFT ▼ (PANIC) button to place the cursor next to **CAL CODE**.
3. Press and release the POWER/ENTER button.

- The current calibration code will be displayed and it will be flashing.



- Use ▲AIR or SHIFT ▼ (PANIC) to adjust the calibration code to match the one listed on your filter tube box's label.
- Press and release the POWER/ENTER button to confirm the calibration code. The screen will show "END" and will return to the Calibration Mode menu.
- Use the SHIFT ▼ (PANIC) button to place the cursor next to the **NORMAL MODE** menu option, then press and release the POWER/ENTER button to return to Measuring Mode.

---

## Maintenance

### Replacing a Sensor

See "Replacing a Sensor" on page 116 for sensor replacement instructions.

### PID Sensor Maintenance

See "PID Sensor Maintenance" on page 120 for PID sensor maintenance instructions keeping in mind the following differences in spare parts.

Part Number	Description
33-0563	PID sensor electrode stack, 10.0 eV/benzene sensor
51-1503	PID sensor replacement lamp, 10.0 eV/benzene sensor
PID-003L	PID sensor, 10.0 eV/benzene

### Replacing a Tube

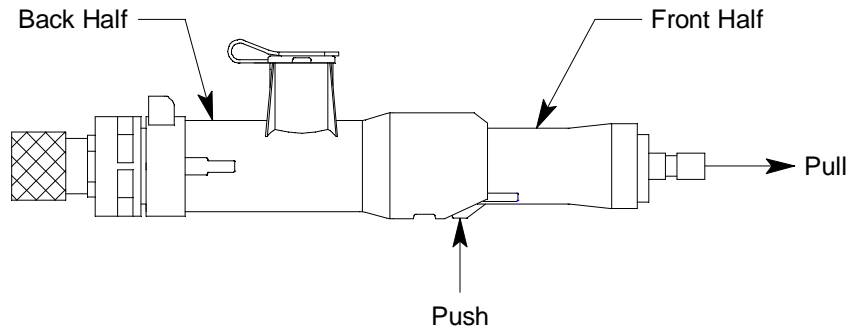
#### *When to Replace Tube*

RKI Instruments, Inc. recommends that the tube be replaced before starting a new measurement in Benzene Select Mode. If discoloration of the filter material extends beyond the "3/4" line (into the side without the text and arrow), the tube needs to be replaced. Even though discoloration can be a measure of when to replace the tube, not all gases cause the filter material to discolor which is why RKI Instruments, Inc. recommends that the tube be replaced before starting a new measurement in Benzene Select Mode.

If the tubes are being stored in a refrigerator, take them out of the refrigerator and let them sit overnight before using them.

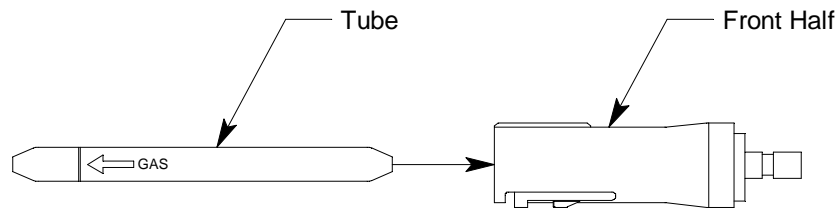
## Instructions to Replace Tube

1. Remove the front of the tube holder by pushing on the locking mechanism and pulling the front half away from the back half, shown below.



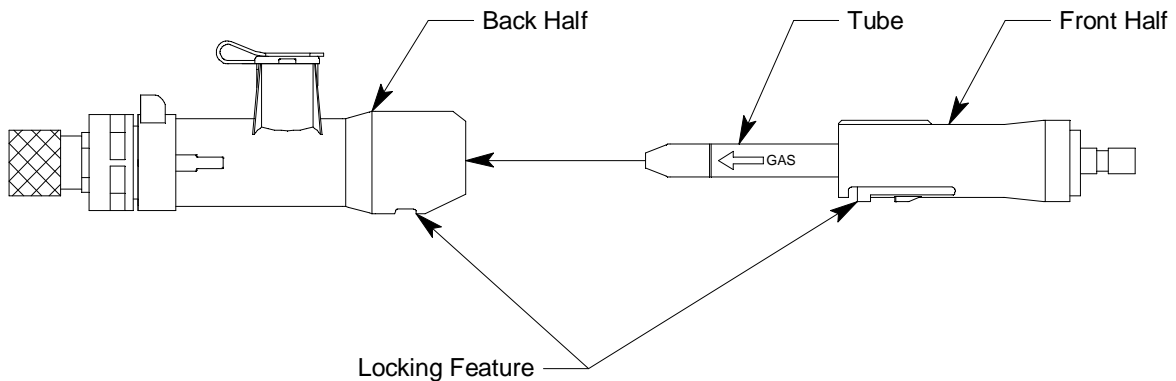
**Figure 47: Replacing a Tube**

2. Remove the used tube. Take care not to touch the broken ends of the tube.
3. Break off the tips of the new tube using the tip-breaking feature in the tube holder. The reservoir can hold approximately 12 tips and will need to be periodically emptied.
4. Insert the new tube in the front half of the tube holder. The arrow on the tube should be pointing away from the front half.



**Figure 48: Inserting New Tube Into Front Half**

5. Line up the locking feature in the front half with its mate in the back half and insert the front half/tube assembly into the back half making sure the locking feature engages.



**Figure 49: Reassembling Tube Holder**

6. If you are replacing your old tube with a tube from a new box, compare the calibration code listed on the old box to the calibration code listed on the new box.
  - a. If the calibration codes match, there is no need to do anything else.
  - b. If the calibration codes do not match, you must either perform a TUBE CAL using a tube from the new box (see “Performing a TUBE CAL” on page 221) or you must enter the new calibration code into CAL CODE (see “Entering a CAL CODE” on page 228), depending on what method of calibration you used with your old box of filter tubes. See “Calibrating the 10.0 eV/Benzene PID Sensor” on page 219 for a description of calibration methods.
7. Tubes do not contain cadmium, mercury, or chrome and may be disposed as general waste.

---

## Parts List for 10.0 eV/Benzene PID Instruments

The table below lists spare parts for a 10.0 eV /benzene PID instrument.

**Table 29: Spare Parts List for 10.0 eV/Benzene PID Instruments**

Part Number	Description
33-0563	PID sensor electrode stack, 10.0 eV/benzene sensor
33-7128	Filter tubes, 1 box, 10 tubes per box
33-7128-05	Filter tubes, 5 boxes, 10 tubes per box
51-1503	PID sensor replacement lamp, 10.0 eV/benzene sensor
80-0174	Tube holder
81-0100RK-03	Calibration cylinder, benzene, 5 ppm in air, 103 liter
81-0100RK-04	Calibration cylinder, benzene, 5 ppm in air, 34 liter aluminum
81-0104RK-03	Calibration cylinder, isobutylene, 10 ppm in air, 103 liter
81-0104RK-04	Calibration cylinder, isobutylene, 10 ppm in air, 34 liter aluminum
81-6XAX-DLV	Calibration kit: 34 liter 10 ppm IBL in air cylinder, demand flow regulator, calibration tubing
81-6XZX	Calibration kit: 103 liter 5 ppm benzene in air cylinder, demand flow regulator, calibration tubing
81-6XZX-DLV	Calibration kit: 34 liter 5 ppm benzene in air cylinder, demand flow regulator, calibration tubing
PID-003L	PID sensor, 10.0 eV/benzene

# Appendix I: 11.7 eV PID Sensor

---

## Overview

This appendix describes the GX-6000's 11.7 eV PID sensor (RKI part number PID-004).

The 11.7 eV PID sensor detects VOCs in the 0-1000 ppm range. The standard calibration for the 11.7 eV PID sensor is to isobutylene but it can be factory setup for and calibrated to other gases. Regardless of the calibration gas, the 11.7 eV PID sensor will still detect and respond to a variety of volatile organic compounds (VOCs) while used in Measuring Mode.

The 11.7 eV PID sensor is capable of detecting VOCs that the 10.6 eV low range and high range PID sensors are not, such as:

- acrylonitrile
- carbon tetrachloride
- chloroform
- methanol
- refrigerants (R-32A, R-143)

See the table below for 11.7 eV PID sensor specifications.

**Table 30: 11.7 eV PID Sensor Specifications**

<b>Detection Range</b>	0 - 1000 ppm
<b>Reading Increment</b>	0 - 100 ppm: 0.1 ppm 100 - 1000 ppm: 1 ppm
<b>Alarm 1 Factory Setting</b>	400 ppm
<b>Alarm 2 Factory Setting</b>	1000 ppm
<b>STEL Alarm</b>	60.0
<b>TWA Alarm</b>	40.0

---

## 11.7 eV PID Lamp Warranty

The PID-004 11.7 eV PID sensor's lamp (RKI P/N 51-1504) is susceptible to humidity and its service life is not as long as lamps in other PID sensors sold by RKI Instruments, Inc. For this reason, the PID-004 11.7 eV sensor's lamp is warranted for 2 months from the date of shipment.



---

## Description

### Instrument

A GX-6000 that contains an 11.7 eV PID sensor is shipped with a black rubber cap plugging the inlet fitting. This rubber cap helps prolong the life of the 11.7 eV PID sensor by preventing ambient moisture from entering the flow system. This rubber cap should be installed back onto the inlet fitting before storing the GX-6000. See “Turning Off a GX-6000 with an 11.7 eV PID Sensor” on page 235 for complete storage recommendations.

### Sensor

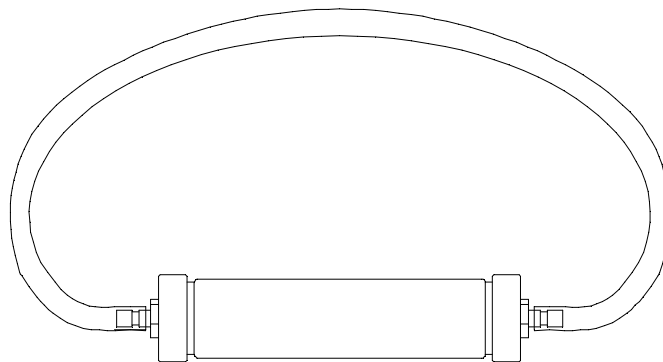
The PID sensor is a cylindrical sensor with a diffusion opening on the front and 3 pins on the back. It is installed in a white housing that has three sockets on the bottom that mate with the GX-6000 instrument. The PID sensor must always be installed in the first smart sensor position which is located in the top left corner of the sensor block.

The 11.7 eV PID sensor’s lamp is susceptible to humidity. “Turning Off a GX-6000 with an 11.7 eV PID Sensor” on page 235 outlines RKI Instruments, Inc.’s recommendations for prolonging the life of the sensor’s lamp.

### Dehumidifier Filter

Every GX-6000 that contains an 11.7 eV PID sensor is shipped with a calcium chloride dehumidifier filter. The dehumidifier filter is shipped with clear tubing connecting both ends together to preserve the life of the filter. Remove the tubing from one end of the filter and draw through the filter before turning off the GX-6000 in order to purge any moisture from the flow system.

The filter should be replaced when it appears wet.

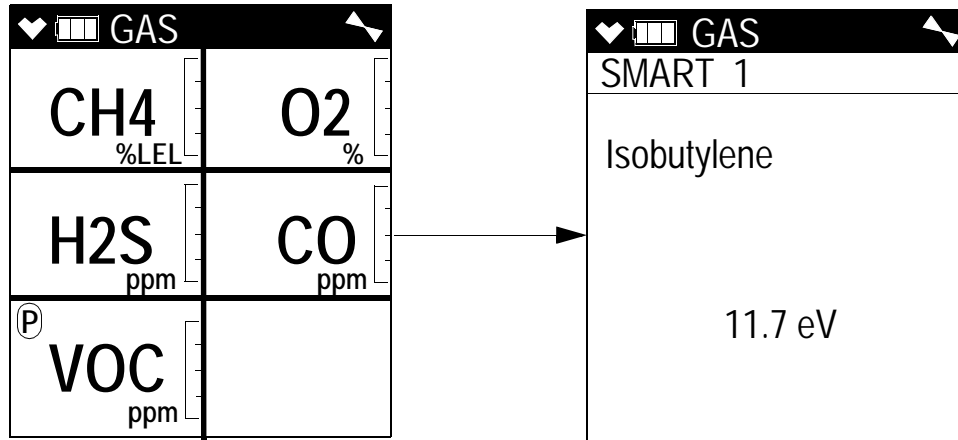


---

## Start Up

The instructions for starting up a GX-6000 with a 11.7 eV PID sensor installed are the same as described in “Start Up” on page 25 with the following exceptions:

- Remove the black cap from the inlet fitting before turning on the instrument.
- The screens shown in Step 8 appear as shown below.

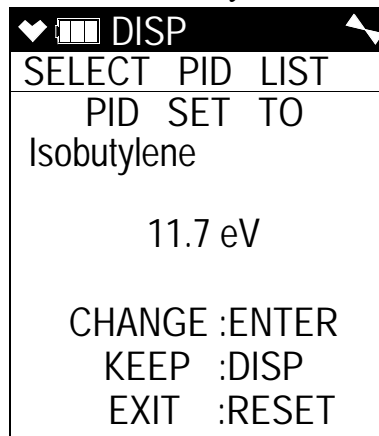


---

## Display Mode

Display Mode for a 11.7 eV PID instrument appears and functions as described in “Display Mode” on page 47 with the following exception:

- The PID Gas Name Screen operates as described in “PID Gas Name Screen” on page 49 but appears as shown below. If there are 2 PID sensors installed in your GX-6000, the PID Gas Name Screens will appear in Display Mode in the following order regardless of their position in the flow system: 10.0 eV/benzene, 10.6 eV, 11.7 eV.



---

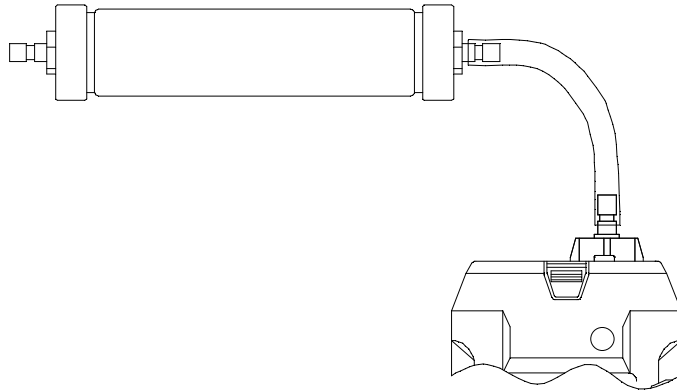
## Measuring Mode

The 11.7 eV PID sensor detects VOCs in the 0-1000 ppm range. In the 0-100 ppm range, the reading increment is 0.1 ppm. In the 100-1000 ppm range, the reading increment is 1 ppm. See “Measuring Mode, Normal Operation” on page 35 for a complete description of Measuring Mode.

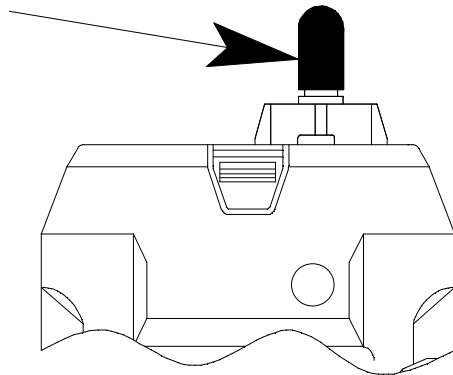
### Turning Off a GX-6000 with an 11.7 eV PID Sensor

Eliminating as much moisture from the flow system as possible before turning off the GX-6000 will help prolong the life of the 11.7 eV PID sensor’s lamp.

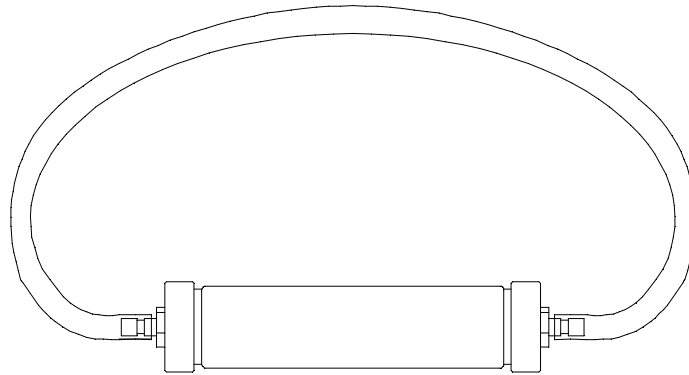
1. Remove the tubing from one end of the dehumidifier filter. It does not matter which end you remove. The dehumidifier filter does not have a flow direction. Do not use the dehumidifier filter if it appears wet.
2. Connect the tubing to the GX-6000’s inlet.



3. Allow the GX-6000 to draw through the filter for 30 seconds.
4. Turn off the GX-6000.
5. Remove the tubing from the inlet fitting and immediately plug the inlet fitting with the black rubber cap.



- 6. Reconnect the tubing to the open end of the dehumidifier filter to help preserve its life. If the filter begins to appear wet, it needs to be replaced.



## Calibrating the 11.7 eV PID Sensor

### Setting the Fresh Air Reading

See “Setting the Fresh Air Reading” on page 72 for instructions to set the fresh air reading.

### Performing an AUTO CAL

See “Calibrating Using the Auto Calibration Method” on page 72 for instructions to perform an automatic calibration while keeping the following in mind:

- If the 11.7 eV PID sensor is one of two PID sensors installed in your instrument, both channels may appear as “VOC”. The channel that appears first will be based on the following sensor priority. Be sure to select the correct PID sensor for calibration.

High Priority	10.6 eV low range PID
↓	10.0 eV/benzene PID
↓	11.7 eV PID
Low Priority	10.6 eV high range PID

**NOTE:** If you have changed the factory-set channel assignments using the **CONFIGURE CH** menu item in User Mode, the order of displayed sensors may be different and you will need to remember how you set your instrument up.

- When turning off the GX-6000 after performing a calibration, follow the instructions in “Turning Off a GX-6000 with an 11.7 eV PID Sensor” on page 235.

## Performing a SINGLE CAL

See “Calibrating Using the Single Calibration Method” on page 83 for instructions to perform a single calibration while keeping the following in mind:

- If the 11.7 eV PID sensor is one of two PID sensors installed in your instrument, both channels may appear as “VOC”. The channel that appears first will be based on the following sensor priority. Be sure to select the correct PID sensor for calibration.

High Priority	10.6 eV low range PID
↓	10.0 eV/benzene PID
↓	11.7 eV PID
Low Priority	10.6 eV high range PID

---

**NOTE:** If you have changed the factory-set channel assignments using the **CONFIGURE CH** menu item in User Mode, the order of displayed sensors may be different and you will need to remember how you set your instrument up.

---

- When turning off the GX-6000 after performing a calibration, follow the instructions in “Turning Off a GX-6000 with an 11.7 eV PID Sensor” on page 235.
- 

## Maintenance

### Replacing the Dehumidifier Filter

RKI Instruments, Inc. recommends replacing the dehumidifier filter when it looks wet.

### Replacing a Sensor

See “Replacing a Sensor” on page 116 for sensor replacement instructions.

### PID Sensor Maintenance

RKI Instruments, Inc. recommends that you replace the electrode stack every time you replace the lamp. However, if you replace only the lamp and notice that the instrument is operating properly, it is not necessary to change the electrode stack.

See “PID Sensor Maintenance” on page 120 for PID sensor maintenance instructions keeping in mind the following differences in spare parts.

Part Number	Description
33-0564	PID sensor electrode stack, 11.7 eV sensor
51-1504	PID sensor replacement lamp, 11.7 eV sensor
PID-004	PID sensor, 11.7 eV

---

## Parts List for 11.7 eV PID Instruments

The table below lists spare parts for a 11.7 eV PID instrument.

**Table 31: Spare Parts List for 11.7 eV PID Instruments**

Part Number	Description
07-0220	Rubber cap, black, for dehumidifier filter and GX-6000 inlet fitting
33-0564	PID sensor electrode stack, 11.7 eV sensor
33-2125-01	Dehumidifier filter with tubing
51-1504	PID sensor replacement lamp, 11.7 eV sensor
81-0103RK-03	Calibration cylinder, isobutylene, 100 ppm in air, 103 liter
81-0103RK-04	Calibration cylinder, isobutylene, 100 ppm in air, 34 liter aluminum
81-0143RK-02	Calibration cylinder, 5-gas (Proprietary blend of IBL, CH <sub>4</sub> , O <sub>2</sub> , H <sub>2</sub> S, CO), 58-liter aluminum
81-0143RK-04	Calibration cylinder, 5-gas (Proprietary blend of IBL, CH <sub>4</sub> , O <sub>2</sub> , H <sub>2</sub> S, CO), 34-liter aluminum
81-6ABX-DLV	Calibration kit: 34 liter five-gas (IBL/CH <sub>4</sub> /O <sub>2</sub> /H <sub>2</sub> S/CO) cylinder, demand flow regulator, calibration tubing
PID-004	PID sensor, 11.7 eV

---

## Warranty

RKI Instruments, Inc. warrants the GX-6000 sold by us to be free from defects in materials, workmanship, and performance for a period of two years from the date of shipment from RKI Instruments, Inc. This includes the instrument and the original sensors. Replacement parts are warranted for 1 year from the date of their shipment from RKI Instruments, Inc. except for replacement sensors which are warranted for 2 years. PID sensors are warranted for 1 year from date of shipment from RKI Instruments, Inc. whether they are new or a replacement part. The 11.7 eV PID sensor's lamp is warranted for 2 months from date of shipment from RKI Instruments, Inc. Any parts found defective within their warranty period will be repaired or replaced, at our option, free of charge. This warranty does not apply to those items which by their nature are subject to deterioration or consumption in normal service, and which must be cleaned, repaired, or replaced on a routine basis. Examples of such items are:

- Absorbent cartridges
- Filter elements, disks, or sheets
- Pump diaphragms and valves
- PID sensor electrode stacks

Warranty is voided by abuse including mechanical damage, alteration, rough handling, or repair procedures not in accordance with the instruction manual. This warranty indicates the full extent of our liability, and we are not responsible for removal or replacement costs, local repair costs, transportation costs, or contingent expenses incurred without our prior approval.

THIS WARRANTY IS EXPRESSLY IN LIEU OF ANY AND ALL OTHER WARRANTIES AND REPRESENTATIONS, EXPRESSED OR IMPLIED, AND ALL OTHER OBLIGATIONS OR LIABILITIES ON THE PART OF RKI INSTRUMENTS, INC. INCLUDING BUT NOT LIMITED TO THE WARRANTY OF MERCHANTABILITY OR FITNESS FOR A PARTICULAR PURPOSE. IN NO EVENT SHALL RKI INSTRUMENTS, INC. BE LIABLE FOR INDIRECT, INCIDENTAL, OR CONSEQUENTIAL LOSS OR DAMAGE OF ANY KIND CONNECTED WITH THE USE OF ITS PRODUCTS OR FAILURE OF ITS PRODUCTS TO FUNCTION OR OPERATE PROPERLY.

This warranty covers instruments and parts sold to users only by authorized distributors, dealers, and representatives as appointed by RKI Instruments, Inc.

We do not assume indemnification for any accident or damage caused by the operation of this gas monitor and our warranty is limited to replacement of parts or our complete goods.